



English

Français

Español

DAIKIN ROOM AIR CONDITIONER

OPERATION MANUAL



Enjoy year-round comfort.

MODELS

FVXS09WVJU9
FVXS12WVJU9
FVXS15WVJU9
FVXS18WVJU9



The two-dimensional bar code is a manufacturing code.
It is not a customer bar code.

Features

Enhanced comfort and energy savings



ECONO

This function enables efficient operation by limiting the maximum power consumption. It is useful when using the air conditioner and other electrical devices simultaneously on a shared electrical circuit.

▶ Page 15



WEEKLY TIMER

Up to 4 timer settings can be saved for each day of the week according to your family's lifestyle. The WEEKLY TIMER allows you to set on/off times and the desired temperature. ▶ Page 19



QUIET OUTDOOR UNIT



QUIET OUTDOOR UNIT operation assures a low noise level of the outdoor unit. This function is useful to maintain a quiet neighborhood. ▶ Page 16

Contents



■ Read Before Operation

Safety Considerations.....	3
Names of Parts	5
Preparation Before Operation.....	9



■ Basic Operation

 AUTO · DRY · COOL · HEAT · FAN Operation	11
 Adjusting the Airflow Rate.....	12
 Adjusting the Airflow Direction	13

■ Useful Functions

 POWERFUL Operation.....	15
 ECONO Operation	15
 QUIET OUTDOOR UNIT Operation	16

■ TIMER Operation

 ON/OFF TIMER Operation	17
 WEEKLY TIMER Operation.....	19

■ Multi Connection

Note for Multi System	25
-----------------------------	----

■ Care

Care and Cleaning.....	27
------------------------	----

■ When the Need Arises

FAQ	32
Troubleshooting	33



Safety Considerations

Refer also to the General Safety Considerations in the separate booklet.

	Read the precautions in this manual carefully before operating the unit.
---	---

Read these **Safety Considerations for Operations** carefully before operating an air conditioner or heat pump.

Make sure that the unit operates properly during the startup operation. Instruct the user on how to operate and maintain the unit. Inform users that they should store this operation manual with the installation manual for future reference.

Meanings of **DANGER**, **WARNING**, **CAUTION**, and **NOTE** Symbols:

 **DANGER** Indicates an imminently hazardous situation which, if not avoided, will result in death or serious injury.

 **WARNING** Indicates a potentially hazardous situation which, if not avoided, could result in death or serious injury.

 **CAUTION** Indicates a potentially hazardous situation which, if not avoided, may result in minor or moderate injury. It may also be used to alert against unsafe practices.

 **NOTE** Indicates situations that may result in equipment or property damage accidents only.

DANGER

- Do not install the unit in an area where flammable materials are present due to risk of explosion resulting in serious injury or death.
- Any abnormalities in the operation of the air conditioner or heat pump, such as smoke or fire, could result in severe injury or death. Turn off the power and contact your dealer immediately.
- Refrigerant gas may produce toxic gas if it comes into contact with fire, such as from a fan heater, stove, or cooking device. Exposure to this gas could cause severe injury or death.
- For refrigerant leakage, consult your dealer. Refrigerant gas is heavier than air and replaces oxygen. A massive leak could lead to oxygen depletion, especially in basements, and an asphyxiation hazard could occur leading to serious injury or death.
- If equipment utilizing a burner is used in the same room as the air conditioner or heat pump, there is the danger of oxygen deficiency which could lead to an asphyxiation hazard resulting in serious injury or death. Be sure to ventilate the room sufficiently to avoid this hazard.
- Safely dispose of the packing materials. Packing materials, such as nails and other metal or wooden parts, may cause stabs or other injuries.
- Tear apart and throw away plastic packaging bags so that children will not play with them. Children playing with plastic bags face the danger of death by suffocation.

WARNING

- Contact your dealer for repair and maintenance. Improper repair and maintenance may result in water leakage, electric shock, and fire. Only use accessories made by Daikin that are specifically designed for use with the equipment and have them installed by a professional.
- Contact your dealer to move and reinstall the air conditioner or heat pump. Incomplete installation may result in water leakage, electric shock, and fire.
- Never let the indoor unit or the remote controller get wet. Water can cause an electric shock or a fire.
- Never use flammable spray such as hair spray, lacquer, or paint near the unit. Flammable spray may cause a fire.
- When a fuse blows out, never replace it with one of incorrect ampere ratings or different wires. Always replace any blown fuse with a fuse of the same specification.
- Never remove the fan guard of the unit. A fan rotating at high speed without the fan guard is very dangerous.
- Never inspect or service the unit by yourself. Contact a qualified service person to perform this work.
- Turn off all electrical power before doing any maintenance to avoid the risk of serious electric shock; never sprinkle or spill water or liquids on the unit.
- Do not touch the switch with wet fingers. Touching a switch with wet fingers can cause electric shock.
- Do not allow children to play on or around the unit to prevent injury.
- The heat exchanger fins are sharp enough to cut. To avoid injury wear gloves or cover the fins while working around them.
- Do not put a finger or other objects into the air inlet or air outlet. The fan is rotating at high speed and will cause injury.
- Check the unit foundation for damage on a continuous basis, especially if it has been in use for a long time. If left in a damaged condition the unit may fall and cause injury.
- Placing a flower vase or other containers with water or other liquids on the unit could cause a shock or fire if a spill occurs.
- Do not touch the air outlet or horizontal blades while the swing flap is in operation because fingers could get caught and injured.
- Never touch the internal parts of the controller. Do not remove the front panel because some parts inside are dangerous to touch. To check and adjust internal parts, contact your dealer.
- Do not use means to accelerate the defrosting process or to clean, other than those recommended by the manufacturer.
- The appliance must be stored in a room without continuously operating ignition sources (for example: open flames, an operating gas appliance or an operating electric heater).
- Do not pierce or burn.
- Be aware that refrigerants may not contain an odor.

⚠ CAUTION

- Do not use the air conditioner or heat pump for any other purposes other than comfort cooling or heating. Do not use the unit for cooling precision instruments, food, plants, animals or works of art.
- Do not place items under the indoor unit as they may be damaged by condensates that may form if the humidity is above 80% or if the drain outlet gets blocked.
- Before cleaning, stop the operation of the unit by turning the power off or by pulling the supply cord out from its receptacle. Otherwise, an electric shock and injury may result.
- Do not wash the air conditioner or heat pump with excessive water. An electric shock or fire may result.
- Avoid placing the controller in a spot which may be splashed with water. Water entering the controller may cause an electric shock or damage the internal electronic parts.
- Do not operate the air conditioner or heat pump when using a room-fumigation type of insecticide. Failure to observe this could cause the chemicals to be deposited in the unit and can endanger the health of those who are hypersensitive to chemicals.
- Do not turn off the power immediately after stopping operation. Always wait for at least 5 minutes before turning off the power. Otherwise, water leakage may occur.
- The appliance is not intended for use by young children or infirm persons without supervision.
- The remote controller should be kept away from children so they cannot play with it.
- Consult with the installation contractor for cleaning.
- Incorrect cleaning of the inside of the air conditioner or heat pump could make the plastics parts break and cause water leakage or electric shock.
- Do not touch the air inlet or aluminum fin of the air conditioner or heat pump as they can cut and cause injury.
- Do not place objects in direct proximity of the outdoor unit. Do not let leaves and other debris accumulate around the unit. Leaves are a hotbed for small animals which can enter the unit. Once inside the unit, animals can cause the unit to malfunction, and cause smoke or fire when they make contact with electrical parts.
- Do not wipe the controller operation panel with benzene, thinner, chemical dust cloth, etc. The panel may get discolored or the coating can peel off. If it is heavily dirty, soak a cloth in water-diluted neutral detergent, squeeze it well and wipe the panel clean. Then wipe it with another dry cloth.
- Dismantling of the unit, disposal of the refrigerant, oil, and additional parts, should be done in accordance with the relevant local, state, and national regulations.
- Operate the air conditioner or heat pump in a sufficiently ventilated area and not surrounded by obstacles. Do not use the air conditioner or heat pump in the following places.
 - a. Places with a mist of mineral oil, such as cutting oil.
 - b. Locations such as coastal areas where there is a lot of salt in the air.
 - c. Locations such as hot springs where there is a lot of sulfur in the air.
 - d. Locations such as factories where the power voltage varies a lot.
 - e. In cars, boats, and other vehicles.
 - f. Locations such as kitchens where oil may splatter or where there is steam in the air.
 - g. Locations where equipment produces electromagnetic waves.
 - h. Places with an acid or alkaline mist.
 - i. Places where fallen leaves can accumulate or where weeds can grow.
- Take snow protection measures. Contact your dealer for the details of snow protection measures, such as the use of a snow protection hood.
- Do not attempt to do electrical work or grounding work unless you are licensed to do so. Consult with your dealer for electrical work and grounding work.
- Pay attention to operating sound. Be sure to use the following places:
 - a. Places that can sufficiently withstand the weight of the air conditioner or heat pump yet can suppress the operating sound and vibration.
 - b. Places where warm air from the air outlet of the outdoor unit or the operating sound of the outdoor unit does not annoy neighbors.
- Make sure that there are no obstacles close to the outdoor unit. Obstacles close to the outdoor unit may drop the performance of the outdoor unit or increase the operating sound of the outdoor unit.
- Consult your dealer if the air conditioner or heat pump in operation generates unusual noise.
- Make sure that the drainpipe is installed properly to drain water. If no water is discharged from the drainpipe while the air conditioner or heat pump is in the cooling mode, the drainpipe may be clogged with dust or dirt and water leakage from the indoor unit may occur. Stop operating the air conditioner or heat pump and contact your dealer.
- Do not spray the air conditioner unit with any deodorizers, etc. It may cause the unit to malfunction.

⚠ NOTE

- Never press the button of the remote controller with a hard, pointed object. The remote controller may be damaged.
- Never pull or twist the electric wire of the remote controller. It may cause the unit to malfunction.
- Do not place appliances that produce open flames in places that are exposed to the airflow of the unit or under the indoor unit. It may cause incomplete combustion or deformation of the unit due to the heat.
- Do not expose the controller to direct sunlight. The LCD display can become discolored and may fail to display the data.

FTP002M-U

Names of Parts

Indoor Unit

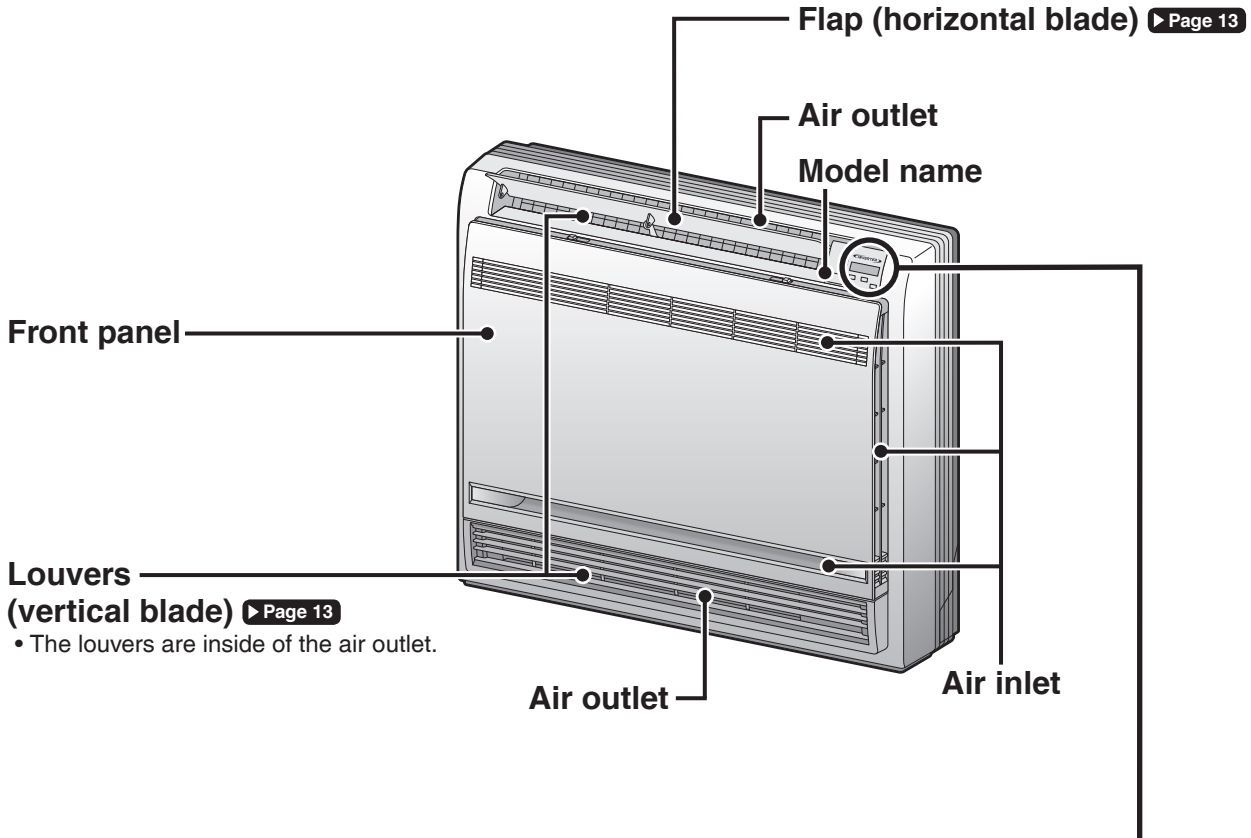

Display

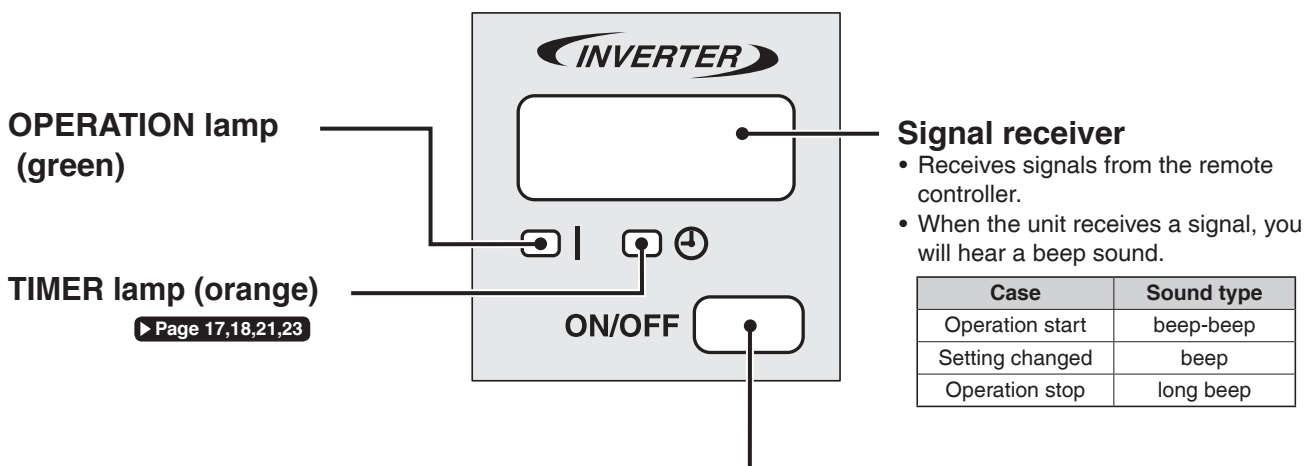

Indoor unit ON/OFF switch

- Press this switch once to start operation. Press once again to stop it.
- For the operation mode setting, refer to the following table.

Mode	Temperature setting	Airflow rate
AUTO	77°F (25°C)	AUTO

- This switch can be used when the remote controller is missing.

■ Open the front panel

- How to open the front panel: ▶ Page 28

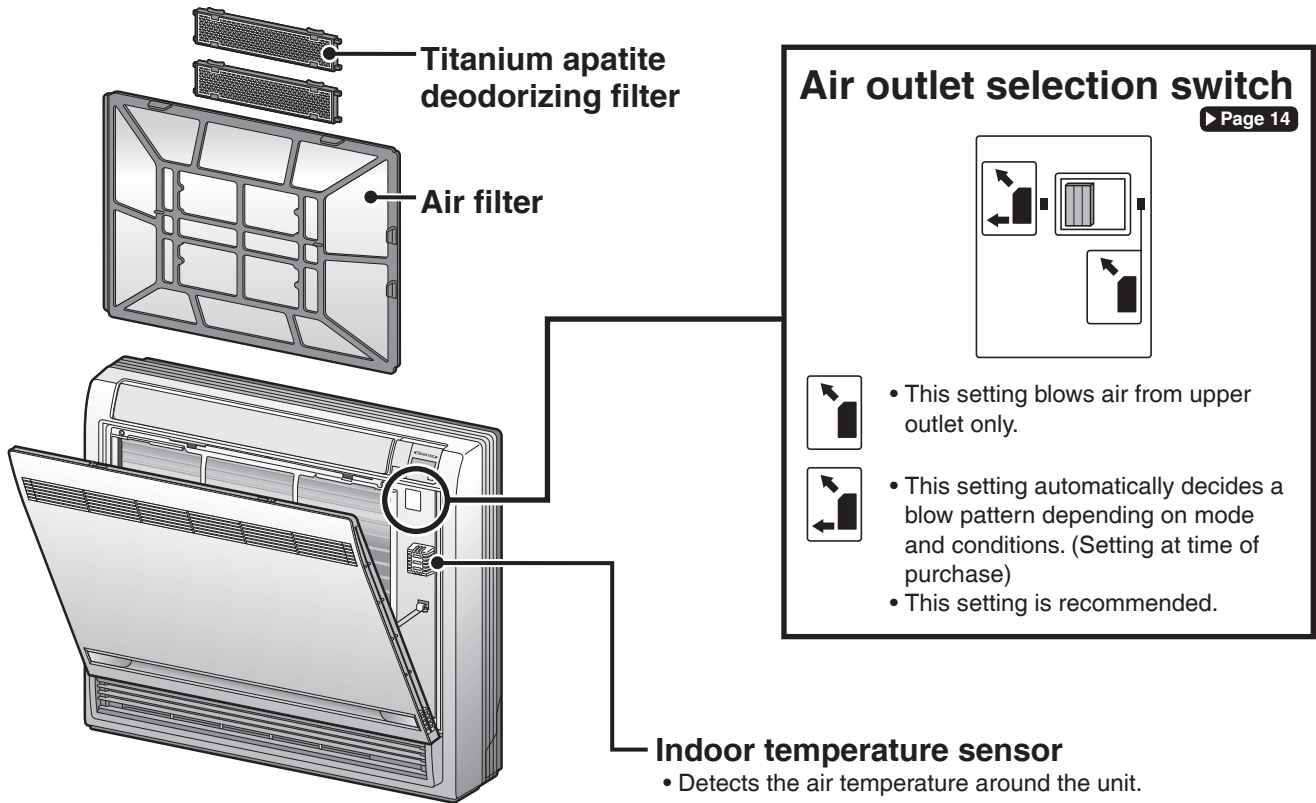

Outdoor Unit

- The appearance of the outdoor unit may differ between different models.

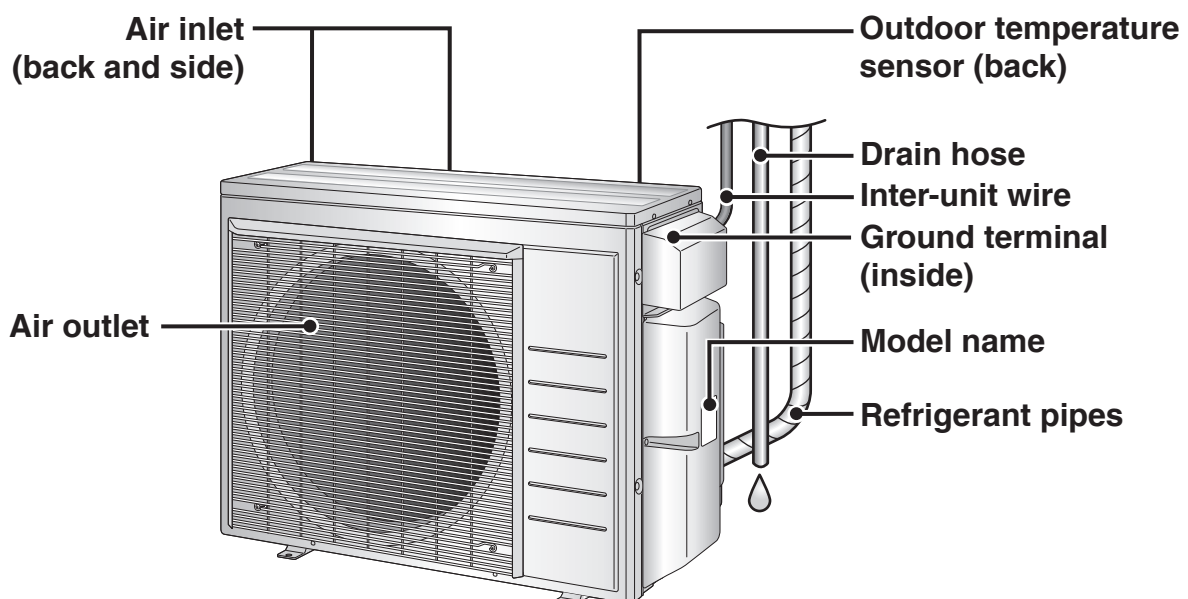

Names of Parts

Remote Controller

Signal transmitter

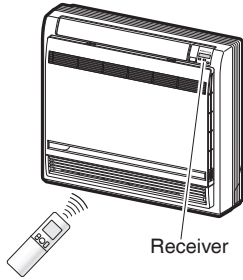

- To use the remote controller, aim the transmitter at the indoor unit. If there is anything blocking the signals between the unit and the remote controller, such as a curtain, the unit may not operate.
- The maximum transmission distance is about 23ft (7m).

FAN setting button

- Selects the airflow rate setting.

▶ Page 12

POWERFUL button

- POWERFUL operation.

▶ Page 15

Display (LCD)

- Displays the current settings. (In this illustration, each section is shown with all its displays on for the purpose of explanation.)

TEMPERATURE adjustment button

- Changes the temperature setting.

▶ Page 11

ON/OFF button

- Press this button once to start operation.

Press once again to stop it. ▶ Page 11

Front cover

- Open the front cover.

Model	ARC466A21
-------	-----------

■ Open the front cover

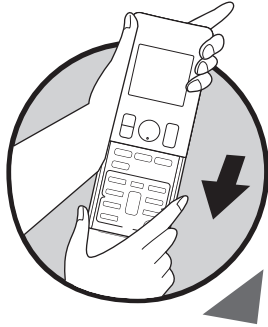

MODE selector button

- Selects the operation mode. (AUTO/DRY/COOL/HEAT/FAN)

▶ Page 11

ECONO button

- ECONO operation.

▶ Page 15

SWING button

- Adjusts the airflow direction.

▶ Page 13

QUIET button

- QUIET OUTDOOR UNIT operation.

▶ Page 16

OFF TIMER button (NIGHT SET mode)

▶ Page 18

TIMER CANCEL button

- Cancels the timer setting.
- Cannot be used for the WEEKLY TIMER operation.

▶ Page 17,18

SELECT button

- Changes the clock, ON/OFF TIMER and WEEKLY TIMER settings.

Weekly : WEEKLY button

◊ : PROGRAM button

Copy : COPY button

Back : BACK button

Next : NEXT button

- WEEKLY TIMER operation.

▶ Page 19

ON TIMER button

▶ Page 17

CLOCK button

▶ Page 10

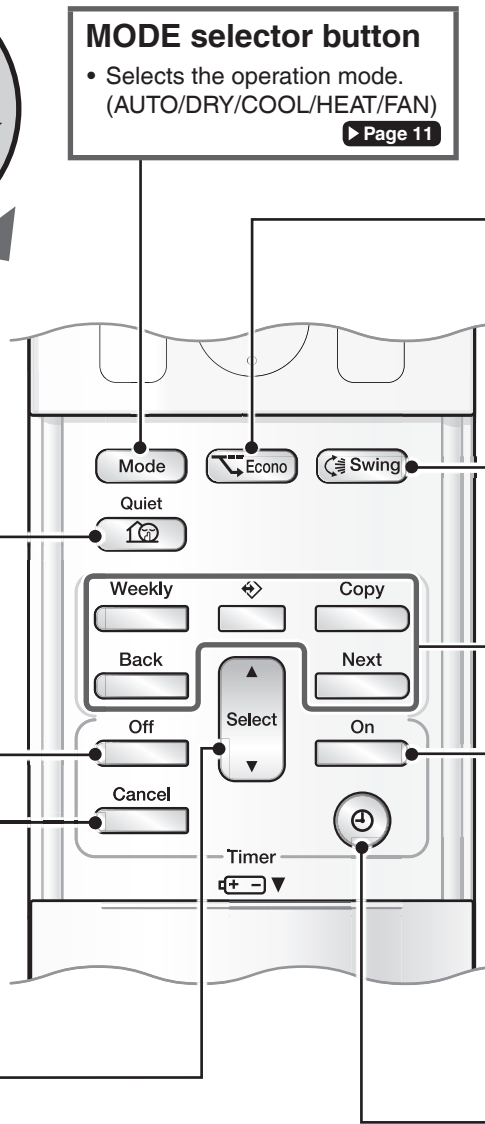

Preparation Before Operation

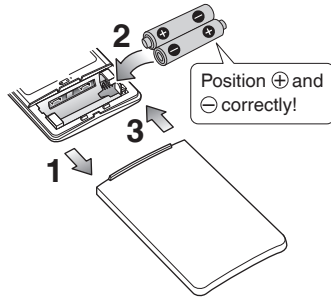

To insert the batteries

- 1.** Slide the front cover to take it off.
- 2.** Insert 2 dry batteries AAA.LR03 (alkaline).
- 3.** Replace the front cover.

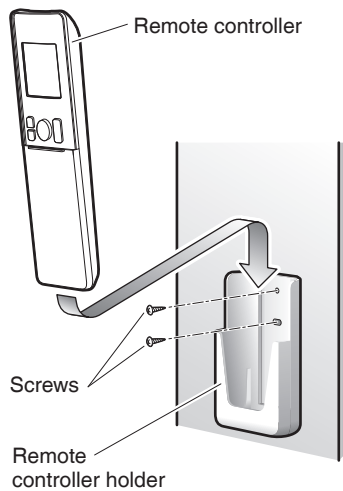

To fix the remote controller holder to a wall

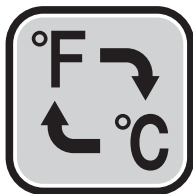

- 1.** Choose a place where the signals reach the unit.
- 2.** Attach the holder to a wall, a pillar, or similar location with the screws supplied with the holder.
- 3.** Place the remote controller in the remote controller holder.

Fahrenheit/Celsius display switch



- Press  and  (TIMER button) simultaneously for about 5 seconds.

- The temperature will be displayed in Celsius when it is presently displayed in Fahrenheit, and vice versa.
- The switch operation is only possible when the temperature is being displayed.

NOTE

Notes on batteries

- When replacing the batteries, use batteries of the same type, and replace both old batteries together.
- The batteries will last for about 1 year. However, if the remote controller display begins to fade and the possible transmission range becomes shorter within a year, replace both batteries with new, size AAA.LR03 (alkaline) batteries.
- The batteries supplied with the remote controller are for initial operation. The batteries may run out in less than 1 year.

Note on remote controller

- Do not drop the remote controller. Do not get it wet.

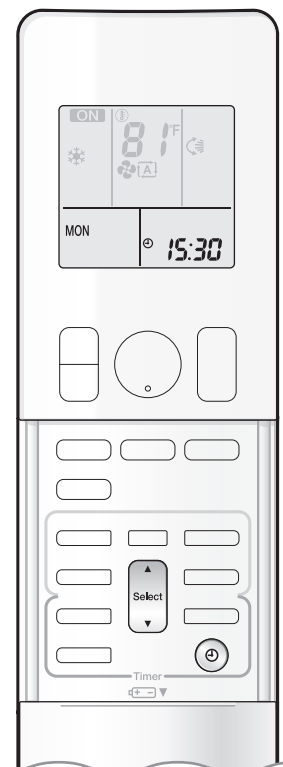

Turn on the circuit breaker

- After the power is turned on, the flaps of the indoor unit open and close once to set the reference position.

To set the clock

1. Press .



“0:00” is displayed on the LCD.
“MON” and “” blink.

2. Press to set the current day of the week.

3. Press .



“” blinks.

4. Press to set the clock to the present time.

- Holding down  or  rapidly increases or decreases the displayed time.

5. Press .

- Point the remote controller at the indoor unit when pressing the buttons.



“.” blinks.

NOTE

Fahrenheit/Celsius display change function of remote controller

- The set temperature may increase when the display is changed to Celsius from Fahrenheit, because a fraction of 0.5°C is rounded up.
- Example: A set temperature of 65°F (equivalent to 18.5°C) will be converted into 19°C.
When the display is changed to Fahrenheit again, the set temperature will be converted into 66°F (equivalent to 19°C) instead of the original set temperature (65°F) but a set temperature of 66°F (equivalent to 19°C) will be converted into 19°C with no temperature change.
- A reception sound will go off for the transmission of set temperature to the indoor unit at the time of setting the Fahrenheit/Celsius display change function.

Note on setting the clock

- If the indoor unit's internal clock is not set to the correct time, the ON/OFF TIMER and WEEKLY TIMER will not operate punctually.



AUTO · DRY · COOL · HEAT · FAN Operation

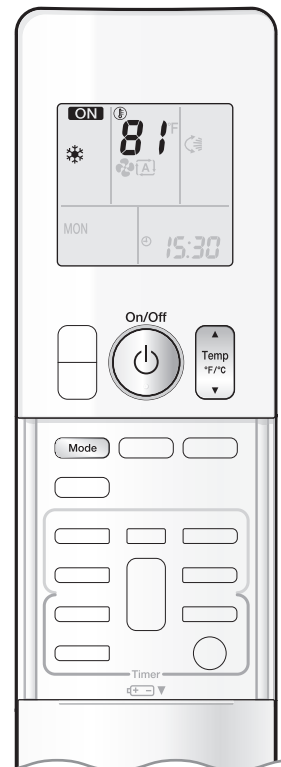

The air conditioner operates with the operation mode of your choice. From the next time on, the air conditioner will operate with the same operation mode.

To start operation

1. Press and select an operation mode.

- Each pressing of the button changes the mode setting in sequence.

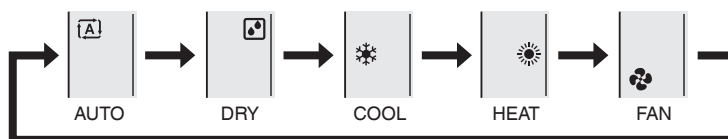

2. Press .

- “**ON**” is displayed on the LCD.
- The OPERATION lamp lights green.

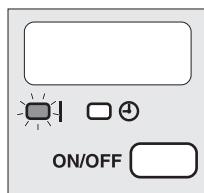

Display

To stop operation

Press again.

- “**ON**” disappears from the LCD.
- The OPERATION lamp goes off.

To change the temperature setting

Press .

- Press ▲ to raise the temperature and press ▼ to lower the temperature.

COOL operation	HEAT operation	AUTO operation	DRY or FAN operation
64-90°F (18-32°C)	50-86°F (10-30°C)	64-86°F (18-30°C)	The temperature setting cannot be changed.

NOTE

Notes on AUTO operation

- In AUTO operation, the system selects an appropriate operation mode (COOL or HEAT) based on the indoor temperature and starts the operation.
- The system automatically reselects setting at a regular interval to bring the indoor temperature to the user-setting level.

Note on DRY operation

- Eliminates humidity while maintaining the indoor temperature as much as possible. It automatically controls temperature and airflow rate, so manual adjustment of these functions is unavailable.



Adjusting the Airflow Rate

You can adjust the airflow rate to increase your comfort.

To adjust the airflow rate setting

Press .

- Each pressing of changes the airflow rate setting in sequence.

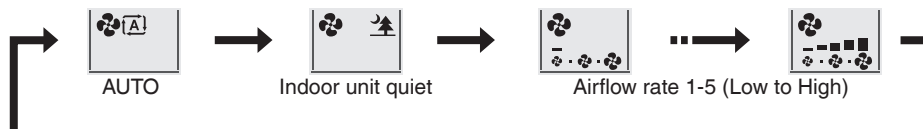

- When the airflow is set to “”, quiet operation starts and noise from the indoor unit will become quieter.
- In the quiet operation mode, the airflow rate is set to a weak level.

AUTO, COOL, HEAT and FAN operation	DRY operation
→ → →	The airflow rate setting cannot be changed.

NOTE

Note on airflow rate setting

- At smaller airflow rates, the cooling (heating) effect is also smaller.

Tips for saving energy

Keeping the temperature setting at a moderate level helps save energy.

- Recommended temperature setting
 - For cooling: 78-82°F (26-28°C)
 - For heating: 68-75°F (20-24°C)

Cover windows with a blind or a curtain.

- Blocking sunlight and air from outdoors increases the cooling (heating) effect.

Keep the air filter clean.

- A clogged air filter causes inefficient operation and wastes energy. Clean it once every 2 weeks. [▶ Page 29](#)

If you are not going to use the air conditioner for a long period, for example in spring or autumn, turn off the circuit breaker.

- The air conditioner always consumes a small amount of electricity even while it is not operating.





Adjusting the Airflow Direction

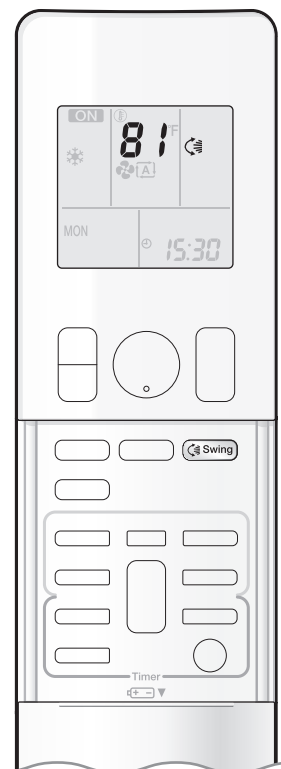

You can adjust the airflow direction to increase your comfort.

⚠ CAUTION

- Always use a remote controller to adjust the angles of the flap. Moving the flap forcibly by hand may cause a malfunction.
- Be careful when adjusting the louvers. Inside the air outlet, a fan is rotating at a high speed.

To start auto swing

Up and down airflow direction

▶ Press  **Swing** .

- “” is displayed on the LCD.
- The flaps (horizontal blades) will begin to swing.

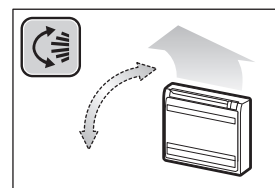

To set the flap at the desired position

- This function is effective while the flap is in auto swing mode.

▶ Press  **Swing** when the flap reaches the desired position.

- “” disappears from the LCD.

To adjust the louvers at desired position

▶ Hold the knobs and move the louvers (vertical blades).

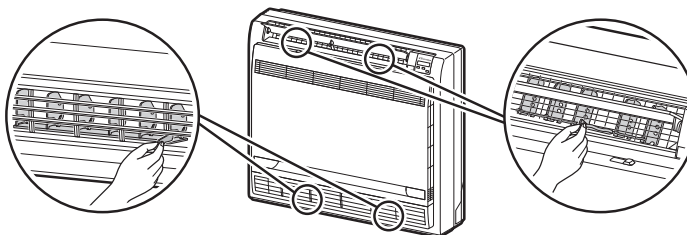

NOTE

Note on airflow direction setting

- The movable range of the flap varies according to the operation mode.
- Unless “Swing” is selected, you should set the flap at a near-horizontal angle in FAN or HEAT operation and at an upward position in COOL or DRY operation to obtain the best performance.

Movable range of the flap

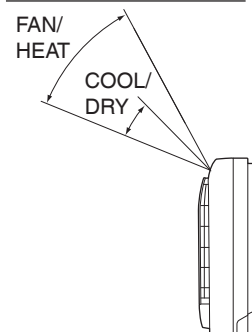





Air outlet selection

- Make air outlet selection according to what suits you. ▶ Page 6

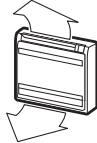
When setting the air outlet selection switch to

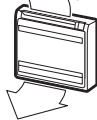
- Air conditioner automatically decides the appropriate blowing pattern depending on the operating mode/situation.

Mode	Situation	Blowing pattern	
COOL (☀️)	When the operation is activated or when the room is not fully cooled.		Air is emitted from the upper and lower air outlets in order to reach the set temperature quickly.
	When the room has become fully cool, or when 1 hour has passed since turning on the air conditioner.		Air is emitted only from the upper air outlet so that air does not come into direct contact with people and indoor temperature is equalized.
HEAT (☀️)	When the operation is activated or when air emitted is of low temperature.		Air is emitted only from the upper air outlet so that air does not come into direct contact with people.
	At times other than the above situations.		Air is emitted from the upper and lower air outlets so that warm air is spread throughout the whole room.
DRY (☀️)	Whenever in DRY mode.		Air is emitted only from the upper air outlet so that air does not come into direct contact with people.
FAN (🌀)	Whenever in FAN mode.		
AUTO (iA)	Operates in the actual operation mode of the air conditioner according to the descriptions in this table. (COOL or HEAT)		

When setting the air outlet selection switch to

- Regardless of the operating mode or situation, air is emitted from the upper air outlet.
- Use this switch when you do not want air coming out of the lower air outlet. (While sleeping, etc.)



POWERFUL Operation

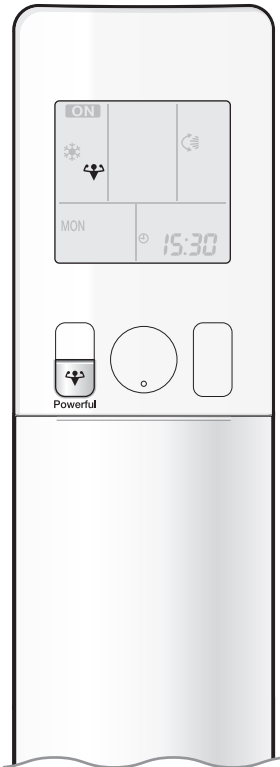

POWERFUL operation quickly maximizes the cooling (heating) effect in any operation mode. In this mode, the air conditioner operates at maximum capacity.

To start POWERFUL operation

▶ Press  during operation.

- “” is displayed on the LCD.
- POWERFUL operation ends in 20 minutes. Then the system automatically operates again with the previous settings which were used before POWERFUL operation.

To cancel POWERFUL operation

▶ Press  again.

- “” disappears from the LCD.



ECONO Operation

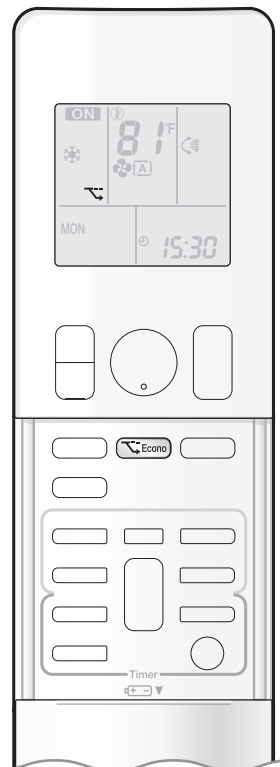

ECONO operation enables efficient operation by limiting the maximum power consumption.

This function is useful to prevent the circuit breaker from tripping when the unit operates alongside other appliances on the same circuit.

To start ECONO operation

▶ Press  during operation.

- “” is displayed on the LCD.
- Not available in FAN ONLY mode.

To cancel ECONO operation

▶ Press  again.

- “” disappears from the LCD.



QUIET OUTDOOR UNIT Operation

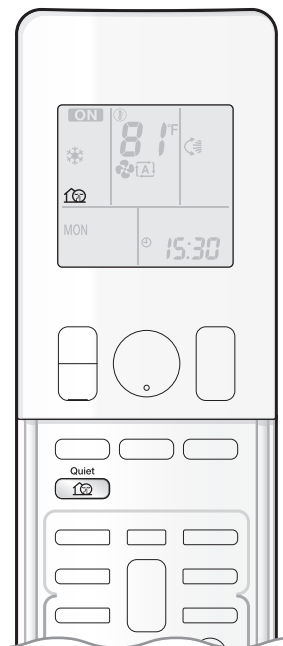

QUIET OUTDOOR UNIT operation lowers the noise level of the outdoor unit by changing the frequency and fan speed of the outdoor unit. This function is convenient during the night-time operation.

To start QUIET OUTDOOR UNIT operation

Press  .

- “” is displayed on the LCD.



To cancel QUIET OUTDOOR UNIT operation

Press  again.



- “” disappears from the LCD.

NOTE

Notes on POWERFUL operation

- Pressing  causes the settings to be canceled, and “” disappears from the LCD.
- POWERFUL operation will not increase the capacity of the air conditioner if the air conditioner is already in operation with its maximum capacity demonstrated.
 - In COOL, HEAT and AUTO operation
To maximize the cooling (heating) effect, the capacity of outdoor unit increases and the airflow rate becomes fixed at the maximum setting. The temperature setting cannot be changed.
 - In DRY operation
The temperature setting is lowered by 4.5°F (2.5°C) and the airflow rate is slightly increased.
 - In FAN ONLY operation
The airflow rate is fixed at the maximum setting.
 - When using priority room setting
Refer to “Note for Multi System”. ▶Page 25

Notes on ECONO operation

- Pressing  causes the settings to be canceled, and “” disappears from the LCD.
- If the power consumption level is already low, switching to ECONO operation will not reduce the power consumption.

Notes on QUIET OUTDOOR UNIT operation

- If using a multi system, the QUIET OUTDOOR UNIT operation will work only when this function is set on all operated indoor units. However, if using priority room setting, refer to “Note for Multi System”. ▶Page 25
- Even if the operation is stopped by using the remote controller or the indoor unit ON/OFF switch when using QUIET OUTDOOR UNIT operation, “” will remain displayed on the remote controller.
- QUIET OUTDOOR UNIT operation will not reduce the frequency nor fan speed if they already are operating at reduced levels.
- This operation is performed with lower power and therefore may not provide a sufficient cooling (heating) effect.

Possible combinations of ECONO / QUIET OUTDOOR UNIT operation and basic operations

	Operation mode				
	AUTO	DRY	COOL	HEAT	FAN
ECONO	✓	✓	✓	✓	–
QUIET OUTDOOR UNIT	✓	–	✓	✓	–

Some useful functions can be used together.

QUIET OUTDOOR UNIT + ECONO	Available
POWERFUL + QUIET OUTDOOR UNIT	Not available*
POWERFUL + ECONO	Not available*

*Priority is given to the function of whichever button is pressed last.



ON/OFF TIMER Operation

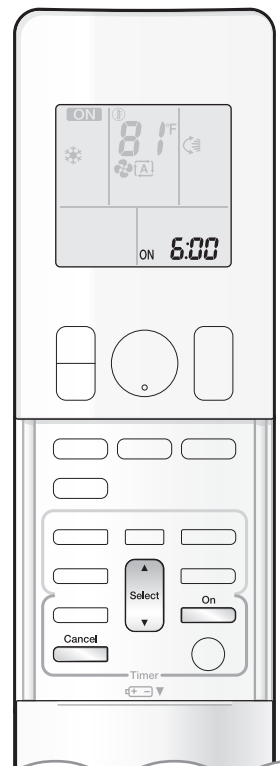

Timer functions are useful for automatically switching the air conditioner on or off at night or in the morning. You can also use the ON TIMER and OFF TIMER together.

To use ON TIMER operation

- Check that the clock is correct.
If not, set the clock to the present time. ▶ Page 10

1. Press .



“6:00” is displayed on the LCD.
“ON” blinks.

- “⌚” and day of the week disappear from the LCD.

2. Press **until the time setting reaches the point you like.**

- Each pressing of either button increases or decreases the time setting by 10 minutes.
Holding down either button changes the setting rapidly.

3. Press **again.**

- “ON” and setting time are displayed on the LCD.
- The TIMER lamp lights orange.

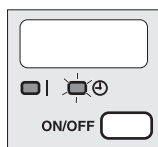

Display

To cancel ON TIMER operation

Press .

- “ON” and setting time disappear from the LCD.
- “⌚” and day of the week are displayed on the LCD.
- The TIMER lamp goes off.

NOTE

Notes on TIMER operation

- When TIMER is set, the present time is not displayed.
- When using the ON/OFF TIMER to start/stop operation, the actual operation start/stop time may differ from the time set. (Maximum of about 10 minutes)

In the following cases, set the timer again.

- After the circuit breaker has turned off.
- After a power failure.
- After replacing the batteries in the remote controller.

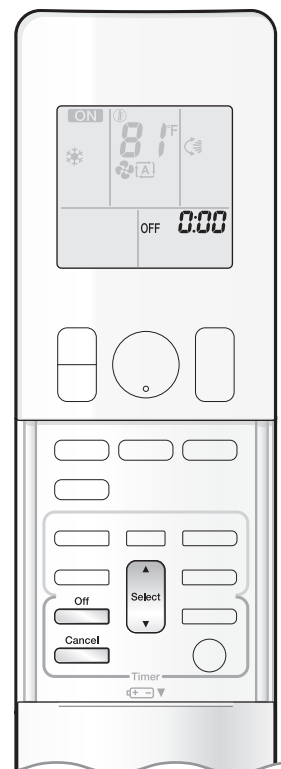

To use OFF TIMER operation

- Check that the clock is correct.
If not, set the clock to the present time. ▶ Page 10

1. Press  .



“0:00” is displayed on the LCD.
“OFF” blinks.

- “⌚” and day of the week disappear from the LCD.

2. Press  **until the time setting reaches the point you like.**

- Each pressing of either button increases or decreases the time setting by 10 minutes.
Holding down either button changes the time setting rapidly.

3. Press  **again.**

- “OFF” and setting time are displayed on the LCD.
- The TIMER lamp lights orange.

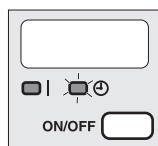

Display

To cancel OFF TIMER operation

Press  .

- “OFF” and setting time disappear from the LCD.
- “⌚” and day of the week are displayed on the LCD.
- The TIMER lamp goes off.

To combine ON TIMER and OFF TIMER operation

- A sample setting for combining the 2 timers is shown below.

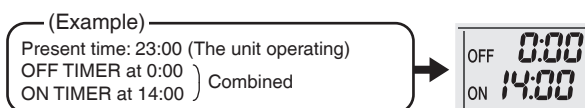

NOTE

NIGHT SET mode

- When the OFF TIMER is set, the air conditioner automatically adjusts the temperature setting (0.9°F (0.5°C) up in COOL, 3.6°F (2.0°C) down in HEAT) to prevent excessive cooling (heating) during sleeping hours.



WEEKLY TIMER Operation

Up to 4 timer settings can be saved for each day of the week. This is convenient to adapt the WEEKLY TIMER to your family's lifestyle.

Setting example of the WEEKLY TIMER

The same timer settings are used from Monday through Friday, while different timer settings are used for the weekend.

<p>[Monday]</p>	<p>Make timer settings for programs 1-4. ▶ Page 20</p> <p>program 1 ON program 2 OFF program 3 ON program 4 OFF</p> <p>6:00 8:30 17:30 22:00</p> <p>77°F (25°C) 81°F (27°C)</p>
<p>[Tuesday to Friday]</p>	<p>Use the copy mode to make settings for Tuesday to Friday, because these settings are the same as those for Monday. ▶ Page 22</p> <p>program 1 ON program 2 OFF program 3 ON program 4 OFF</p> <p>6:00 8:30 17:30 22:00</p> <p>77°F (25°C) 81°F (27°C)</p>
<p>[Saturday]</p>	<p>No timer settings</p>
<p>[Sunday]</p>	<p>Make timer settings for programs 1-4. ▶ Page 20</p> <p>program 1 ON program 2 OFF program 3 OFF program 4 ON</p> <p>8:00 10:00 19:00 21:00</p> <p>77°F (25°C) 81°F (27°C)</p>

- Up to 4 reservations per day and 28 reservations per week can be set using the WEEKLY TIMER. The effective use of the copy mode simplifies timer programming.
- The use of ON-ON-ON-ON settings, for example, makes it possible to schedule operating mode and set temperature changes. Furthermore, by using OFF-OFF-OFF-OFF settings, only the turn off time of each day can be set. This will turn off the air conditioner automatically if you forget to turn it off.

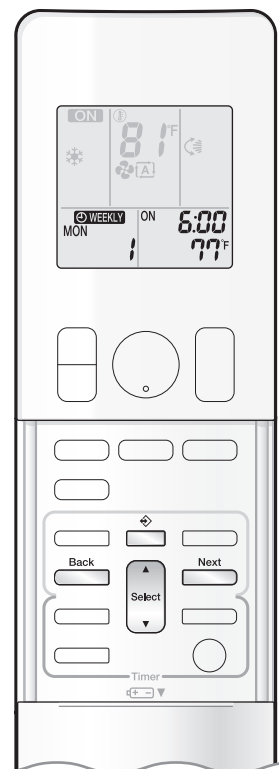

To use WEEKLY TIMER operation

Setting mode

- Make sure the day of the week and time are set.
If not, set the day of the week and time. ▶ [Page 10](#)

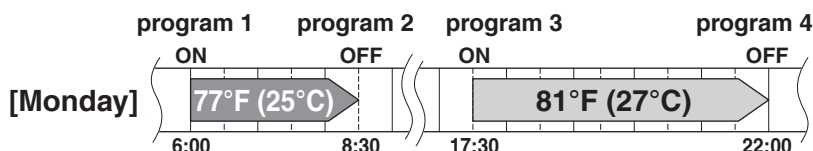

Setting Displays

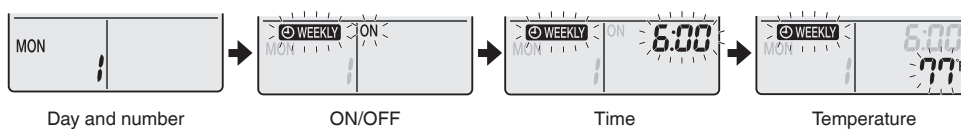

1. Press .

- The day of the week and the reservation number of the current day will be displayed.
- 1 to 4 settings can be made per day.

2. Press to select the desired day of the week and reservation number.

- Pressing  changes the reservation number and the day of the week.

3. Press .

- The day of the week and reservation number will be set.
- “ WEEKLY” and “ON” blink.

4. Press to select the desired mode.

- Pressing  changes the “ON” or “OFF” setting in sequence.



- In case the reservation has already been set, selecting “blank” deletes the reservation.
- Proceed to **STEP 9** if “blank” is selected.
- To return to the day of the week and reservation number setting, press .

5. Press .

- The ON/OFF TIMER mode will be set.
- “ WEEKLY” and the time blink.



WEEKLY TIMER Operation

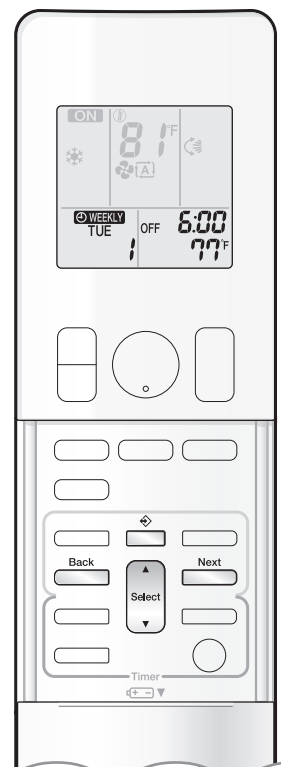



6. Press to select the desired time.

- The time can be set between 0:00 and 23:50 in 10-minute intervals.
- To return to the ON/OFF TIMER mode setting, press .
- Proceed to **STEP 9** when setting the OFF TIMER.

7. Press .

- The time will be set.
- “ ” and the temperature blink.

8. Press to select the desired temperature.

- The temperature can be set between 50°F (10°C) and 90°F (32°C).
COOL or AUTO: The unit operates at 64°F (18°C) even if it is set at 50°F (10°C) to 63°F (17°C). 
- HEAT or AUTO : The unit operates at 86°F (30°C) even if it is set at 87°F (31°C) to 90°F (32°C). 
- To return to the time setting, press .
- The set temperature is only displayed when the mode setting is on.

9. Press .

- The temperature will be set and go to the next reservation setting.
- The temperature is set while in ON TIMER operation, and the time is set while in OFF TIMER operation.
- The next reservation screen will appear.
- To continue further settings, repeat the procedure from **STEP 4**.

10. Press to complete the setting.

- Be sure to direct the remote controller toward the indoor unit and check for a receiving tone and blinking of the OPERATION lamp.
- “ ” is displayed on the LCD and WEEKLY TIMER operation is activated.
- The TIMER lamp lights orange.

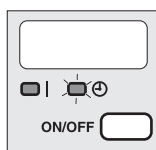





Display

- A reservation made once can be easily copied and the same settings used for another day of the week. Refer to **Copy mode** . 

NOTE

Notes on WEEKLY TIMER operation

- Do not forget to set the clock on the remote controller first. 
- The day of the week, ON/OFF TIMER mode, time and set temperature (only for ON TIMER mode) can be set with the WEEKLY TIMER. Other settings for the ON TIMER are based on the settings just before the operation.
- WEEKLY TIMER and ON/OFF TIMER operation cannot be used at the same time. The ON/OFF TIMER operation has priority if it is set while WEEKLY TIMER is still active. The WEEKLY TIMER will enter the standby state, and “ ” will disappear from the LCD. When the ON/OFF TIMER is up, the WEEKLY TIMER will automatically become active.
- Only the time and set temperature with the WEEKLY TIMER are sent with the . Set the WEEKLY TIMER only after setting the operation mode, the airflow rate and the airflow direction ahead of time.
- Turning off the circuit breaker, power failure, and other similar events will render operation of the indoor unit's internal clock inaccurate. Reset the clock. 
-  can be used only for the time and temperature settings. It cannot be used to go back to the reservation number.

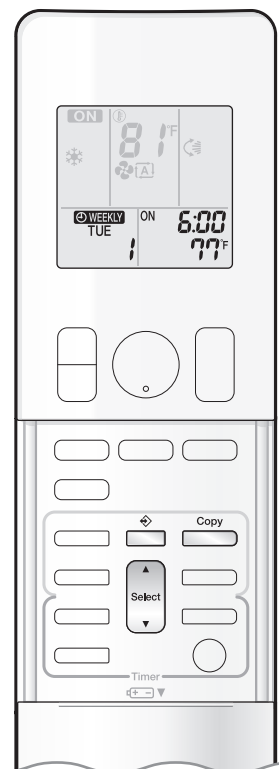

Copy mode

- A reservation made once can be copied to another day of the week. The whole reservation of the selected day of the week will be copied.

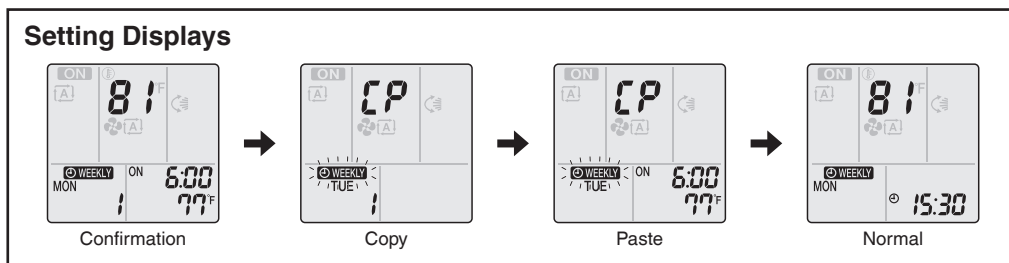
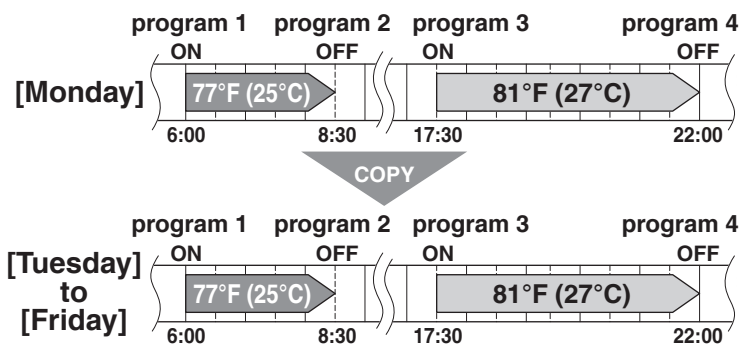

1. Press .
2. Press to confirm the day of the week to be copied.
3. Press .
 - The whole reservation of the selected day of the week will be copied.
4. Press to select the destination day of the week.
5. Press .
 - The reservation will be copied to the selected day of the week. The whole reservation of the selected day of the week will be copied.
 - To continue copying the settings to other days of the week, repeat **STEP 4** and **STEP 5**.
6. Press to complete the setting.
 - “ WEEKLY” is displayed on the LCD and WEEKLY TIMER operation is activated.

NOTE

Note on COPY MODE

- The entire reservation of the source day of the week is copied in the copy mode.
 In the case of making a reservation change for any day of the week individually after copying the content of weekly reservations, press and change the settings in the steps of **Setting mode** . **▶ Page 20**



WEEKLY TIMER Operation

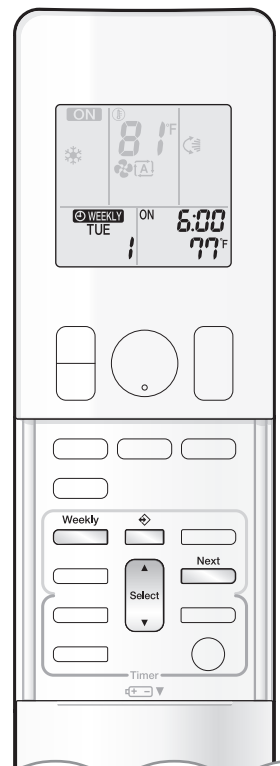

Confirming a reservation

- The reservation can be confirmed.

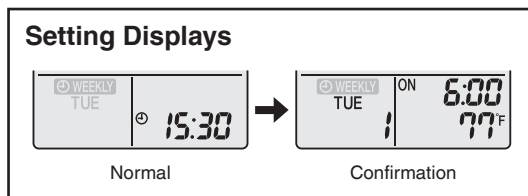

1. Press .

- The day of the week and the reservation number of the current day will be displayed.

2. Press to select the day of the week and the reservation number to be confirmed.

- Pressing displays the reservation details.
- To change the confirmed reserved settings, select the reservation number and press . The mode is switched to setting mode. Proceed to **Setting mode** STEP 4. [▶Page 20](#)

3. Press to exit the confirmation mode.

- “” is displayed on the LCD and WEEKLY TIMER operation is activated.
- The TIMER lamp lights orange.

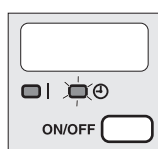

Display

To deactivate WEEKLY TIMER operation

Press while “” is displayed on the LCD.

- “” disappears from the LCD.
- The TIMER lamp goes off.
- To reactivate the WEEKLY TIMER operation, press again.
- If a reservation deactivated with is activated once again, the last reservation mode will be used.

NOTE

- If not all the reservation settings are reflected, deactivate the WEEKLY TIMER operation once. Then press again to reactivate the WEEKLY TIMER operation.

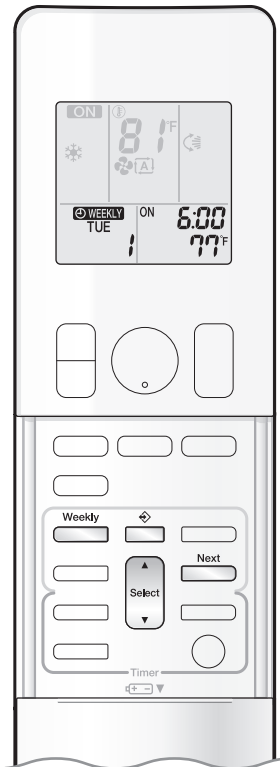

To delete reservations

An individual reservation

1. Press  .

- The day of the week and the reservation number will be displayed.

2. Press  **to select the day of the week and the reservation number to be deleted.**

3. Press  .

- “ WEEKLY” and “ON” or “OFF” blink.

4. Press  **until no icon is displayed.**

- Pressing  changes the ON/OFF TIMER mode in sequence.
- Selecting “blank” will cancel any reservation you may have.

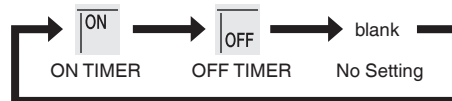

Pressing  puts the sequence in reverse.

5. Press  .

- The selected reservation will be deleted.

6. Press  .

- If there are still other reservations, WEEKLY TIMER operation will be activated.

Reservations for each day of the week

- This function can be used for deleting reservations for each day of the week.
- It can be used while confirming or setting reservations.

1. Press  .

- The day of the week and the reservation number will be displayed.

2. Press  **to select the day of the week to be deleted.**

3. Hold  **for about 5 seconds.**

- The reservation of the selected day of the week will be deleted.

4. Press  .

- If there are still other reservations, WEEKLY TIMER operation will be activated.

All reservations

Hold  **for about 5 seconds with the normal display.**

- Be sure to direct the remote controller toward the indoor unit and check for a receiving tone.
- This operation cannot be used for the WEEKLY TIMER setting display.
- All reservations will be deleted.

Note for Multi System

A multi system has one outdoor unit connected to multiple indoor units.

Selecting the operation mode

When the priority room setting is active but the set unit is not operating or when the priority room setting is inactive

When more than one indoor unit is operating, priority is given to the first unit that was turned on.

In this case, set the units that are turned on later to the same operation mode as the first unit.

Otherwise, they will enter the standby state, and the OPERATION lamp will blink; this does not indicate malfunction.

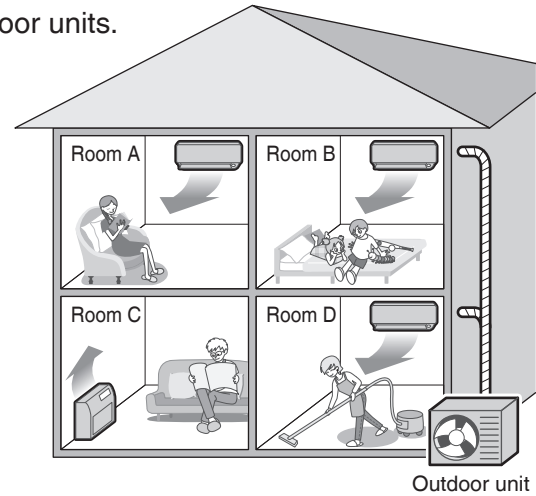

NOTE

Notes on operation mode for a multi system

- COOL, DRY and FAN operation may be used at the same time.
- AUTO operation automatically selects COOL operation or HEAT operation based on the indoor temperature. Therefore, AUTO operation is available when selecting the same operation mode as that of the room with the first unit to be turned on.

CAUTION

- Normally, the operation mode in the room where the unit is first started is given priority, but the following situations are exceptions to this rule. If the operation mode of the first room is FAN operation, then using HEAT operation in any room after this will give priority to HEAT operation. In this situation, the indoor unit operating in FAN mode will switch to standby, and the OPERATION lamp will blink.

With the priority room setting active

Refer to "Priority room setting" on the next page.

NIGHT QUIET operation (Available only for COOL operation)

NIGHT QUIET operation requires initial programming during installation. Please consult your retailer or dealer for assistance. NIGHT QUIET operation reduces the operation noise of the outdoor unit during the night-time hours to prevent annoyance to neighbors.

- NIGHT QUIET operation is activated when the temperature drops 10.8°F (6°C) or more below the highest temperature recorded that day. When the temperature difference between the current outdoor temperature and the maximum outdoor temperature becomes less than 7.2°F (4°C), this function will be canceled.
- NIGHT QUIET operation slightly reduces the cooling efficiency of the unit.

QUIET OUTDOOR UNIT operation

Refer to "QUIET OUTDOOR UNIT Operation". ▶Page 16

When the priority room setting is active but the set unit is not operating or when the priority room setting is inactive

When using the QUIET OUTDOOR UNIT operation feature with a multi system, set all indoor units to QUIET OUTDOOR UNIT operation using their remote controllers.

When canceling QUIET OUTDOOR UNIT operation, simply cancel the mode on one of the operating indoor units using their remote controller.

However QUIET OUTDOOR UNIT operation will remain displayed on the remote controllers for the other rooms.

We recommend you cancel operation in all rooms using their remote controllers.

With the priority room setting active

Refer to "Priority room setting" on the next page.

COOL/HEAT mode lock

The COOL/HEAT mode lock requires initial programming during installation. Please consult your authorized dealer for assistance. The COOL/HEAT mode lock sets the unit forcibly to either COOL or HEAT operation. This function is convenient when you wish to set all indoor units connected to the multi system to the same operation mode.

NOTE

- The COOL/HEAT mode lock cannot be activated together with the priority room setting.

Priority room setting

The priority room setting requires initial programming during installation. Please consult your authorized dealer for assistance. The room designated as the priority room takes priority in the following situations.

Operation mode priority

- As the operation mode of the priority room takes precedence, you can select a different operation mode from other rooms.

[Example]

- Room A is the priority room in this examples.
When COOL operation is selected in room A while operating the following modes in room B, C and D:

Operation mode in room B, C and D	Status of room B, C and D when the unit in room A is in COOL operation
COOL or DRY or FAN	The current operation mode is maintained.
HEAT	The unit enters the standby mode. Operation resumes when the room A unit stops operating.
AUTO	If the unit is set to COOL operation, it continues. If the unit is set to HEAT operation, it enters the standby mode. Operation resumes when the room A unit stops operating.

Priority when POWERFUL operation is used

[Example]

- Room A is the priority room in this examples.
The indoor units in rooms A, B, C and D are all operating. If the unit in room A enters POWERFUL operation, operation capacity will be concentrated in room A. In such a case, the cooling (heating) efficiency of the units in room B, C and D may be slightly reduced.

Priority when QUIET OUTDOOR UNIT operation is used

[Example]

- Room A is the priority room in this examples.
Just by setting the unit in room A to QUIET operation, the air conditioner starts QUIET OUTDOOR UNIT operation. You do not have to set all the indoor units in operation to QUIET OUTDOOR UNIT operation.

Care and Cleaning

⚠ CAUTION

- Before cleaning, be sure to stop the operation and turn off the circuit breaker.
- Do not touch the aluminum fins of the indoor unit. If you touch those parts, this may cause an injury.

■ Quick reference

Cleaning parts

Air filter

- Vacuum dust or wash the filter.

Once every 2 weeks

▶ Page 29

Front panel

- Wipe it with a soft damp cloth.

If dirty ▶ Page 28

Indoor unit, Outdoor unit and Remote controller

- Wipe them with a soft cloth.

If dirty

Titanium apatite deodorizing filter

- Vacuum dust or replace the filter.

[Cleaning]

Once every 6 months

▶ Page 30

[Replacement]

Once every 3 years

▶ Page 30

Notes on cleaning

For cleaning, do not use any of the following:

- Water hotter than 104°F (40°C)
- Volatile liquid such as benzene, petrol and thinner
- Polishing compounds
- Rough materials such as a scrubbing brush
- Sprays such as deodorizers

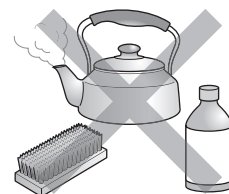

CAUTION

- When removing or attaching the front panel, stand on solid ground and use caution.
- When removing or attaching the front panel, support the panel securely with your hand to prevent it from falling.

■ Front panel

1. Open the front panel.

- Slide the 2 stoppers on the left and right sides inward until they click.

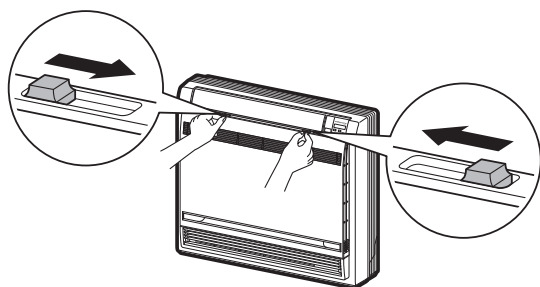

2. Remove the front panel.

- Remove the string.
- Allowing the front panel to fall forward will enable you to remove it.
- Disconnect the front panel hooks from the grooves.

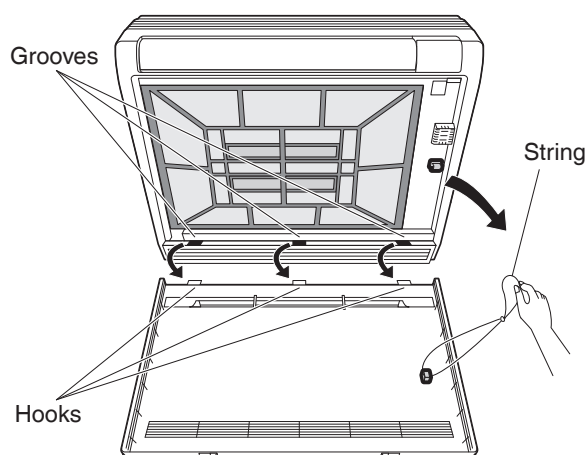

3. Clean the front panel.

- Wipe it with a soft damp cloth.
- Only neutral detergent may be used.
- Wash the panel with water, wipe it with a dry soft cloth, and let it dry in the shade after washing.

4. Reattach the front panel.

- Insert the front panel hooks into the grooves of the unit (3 places).
- Attach the string to the right, inner-side of the front grille.
- Close the panel slowly.

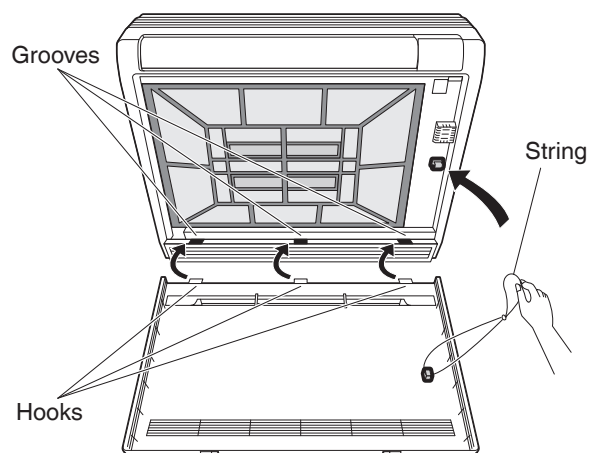

5. Close the front panel slowly.

- Slide the 2 stoppers on the left and right sides outward until they click.

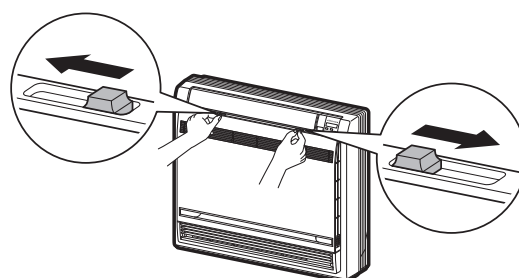

- Make sure that the front panel is securely fixed.

Care and Cleaning

■ Air filter

1. Open the front panel. ▶Page 28

2. Pull out the air filter.

- Press the claws on the right and left of the air filter down slightly, then pull upward.

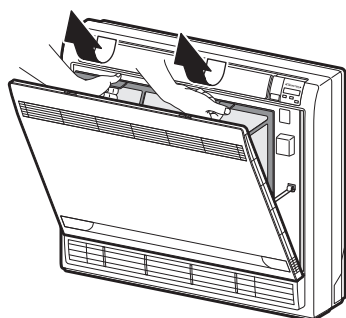

3. Take off the titanium apatite deodorizing filters.

- Hold the recessed parts of the frame and unhook the 4 claws.

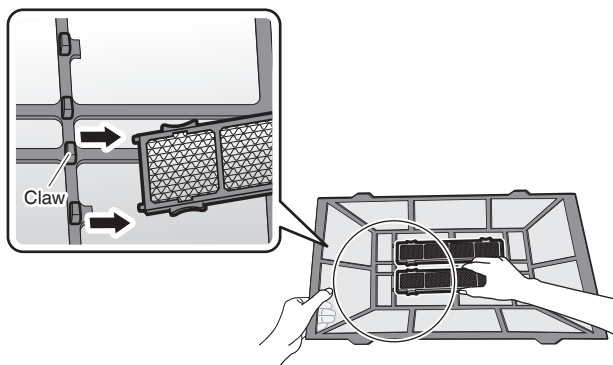

4. Wash the air filter with water or clean it with a vacuum cleaner.

- It is recommended to clean the air filter every 2 weeks.

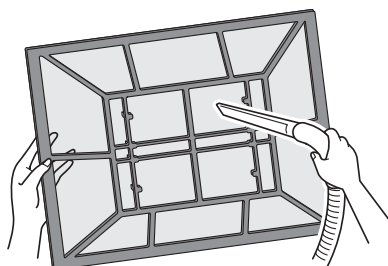

If the dust does not come off easily

- Wash the air filter with neutral detergent thinned with lukewarm water, then let it dry in the shade.
- Be sure to remove the titanium apatite deodorizing filters. Refer to "Titanium apatite deodorizing filter" on the next page.

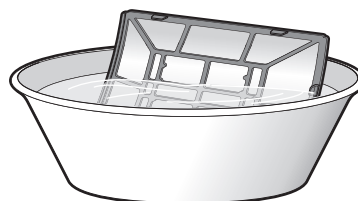

5. Insert the titanium apatite deodorizing filters as they were.

6. Reattach the filters.

7. Close the front panel slowly.

▶Page 28

■ Titanium apatite deodorizing filter

1. Open the front panel and pull out the air filter. ▶Page 28,29

2. Take off the titanium apatite deodorizing filters.

- Hold the recessed parts of the frame and unhook the 4 claws.

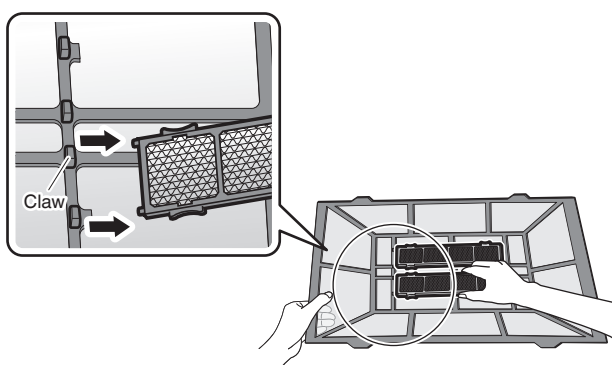

3. Clean or replace the titanium apatite deodorizing filters.

[Cleaning]

3-1 Vacuum dust, and soak in lukewarm water or water for about 10 to 15 minutes if very dirty.

- Do not remove the filter from the frame when washing with water.

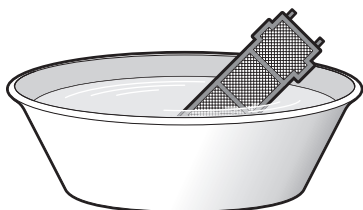

3-2 After washing, shake off remaining water and let them dry in the shade.

- Do not wring out the filter to remove water from it.

[Replacement]

Remove the filter from the filter frame and prepare a new one.

- Do not throw away the filter frame. Reuse the filter frames when replacing the titanium apatite deodorizing filters.

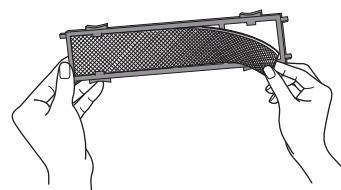

- Dispose of the old filter as non-flammable waste.

4. Insert the titanium apatite deodorizing filters as they were.

- When attaching the filter, check that the filter is properly set in the tabs.

5. Reattach the filters. ▶Page 29

6. Close the front panel slowly.

▶Page 28

NOTE





- Operation with dirty filters:
 - cannot deodorize the air,
 - cannot clean the air,
 - results in poor heating or cooling,
 - may cause odor.
- Dispose of old filters as non-flammable waste.
- To order a titanium apatite deodorizing filter, contact the dealer where you bought the air conditioner.

Item	Titanium apatite deodorizing filter (without frame) 1 set
Part No.	KAF968B42

Care and Cleaning

■ Prior to a long period of non-use

1. Operate the FAN mode for several hours to dry out the inside.

- 1) Press  and select “”.
 - When a multi outdoor unit is connected, make sure the HEAT operation is not being used in other rooms before you use the FAN operation. 
- 2) Press  and start the operation.

2. After operation stops, turn off the circuit breaker for the room air conditioner.

3. Take out the batteries from the remote controller.

■ We recommend periodical maintenance

- In certain operating conditions, the inside of the air conditioner may get foul after several seasons of use, resulting in poor performance. It is recommended to have periodical maintenance by a qualified contractor in addition to regular cleaning by the user.
- For qualified contractor maintenance, please contact the dealer where you bought the air conditioner.

FAQ

Indoor unit

The flap does not start swinging immediately.

- The air conditioner is adjusting the position of the flap. The flap will start moving soon.

Different sounds are heard.

■ A sound like flowing water

- This sound is generated because the refrigerant in the air conditioner is flowing.
- This is a pumping sound of the water in the air conditioner and can be heard when the water is pumped out from the air conditioner during COOL or DRY operation.
- The refrigerant flows in the air conditioner even if the air conditioner is not working when the indoor units in other rooms are in operation.

■ Blowing sound

- This sound is generated when the flow of the refrigerant in the air conditioner is switched over.

■ Ticking sound

- This sound is generated when the cabinet and frame of the air conditioner slightly expand or shrink as a result of temperature changes.

■ Whistling sound

- This sound is generated when refrigerant flows during defrosting operation.

■ Clicking sound during operation or idle time

- This sound is generated when the refrigerant control valves or the electrical parts operate.

■ Clipping sound

- This sound is heard from the inside of the air conditioner when the exhaust fan is activated while the room doors are closed. Open the window or turn off the exhaust fan.

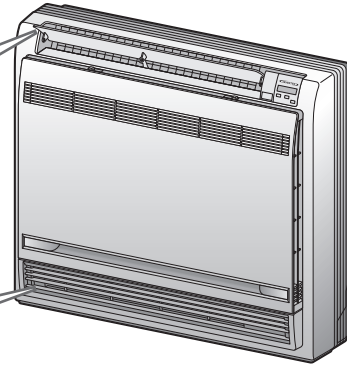

The air conditioner stops generating airflow during HEAT operation.

- Once the set temperature is reached, the airflow rate is reduced and operation stopped in order to avoid generating a cool airflow. Operation will resume automatically when the indoor temperature falls.

HEAT operation stops suddenly and a flowing sound is heard.

- The outdoor unit is defrosting. HEAT operation starts after the frost on the outdoor unit has been removed. This can take about 4 to 12 minutes.

Operation does not start soon.

- When  was pressed soon after operation was stopped.
- When the mode was reselected.
 - This is to protect the air conditioner. You should wait for about 3 minutes.

Outdoor unit

Operating sound is loud.

- When frost forms on the heat exchanger of the outdoor unit, the operating sound level increases slightly.

The outdoor unit emits water or steam.

■ In HEAT operation

- The frost on the outdoor unit melts into water or steam when the air conditioner is in defrosting operation.

■ In COOL or DRY operation

- Moisture in the air condenses into water on the cool surface of the outdoor unit piping and drips.

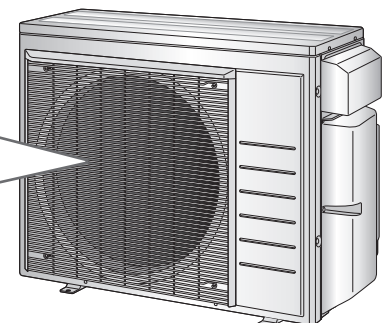

Troubleshooting

Before making an inquiry or a request for repair, please check the following.
If the problem persists, consult your dealer.



Not a problem

This case is not a problem.



Check

Please check again before requesting repairs.

The air conditioner does not operate

Case	Description / what to check
OPERATION lamp is off.	<ul style="list-style-type: none"> Has the circuit breaker been tripped or the fuse blown? Is there a power failure? Are batteries set in the remote controller?
OPERATION lamp is blinking.	<ul style="list-style-type: none"> Check the error code and consult your dealer. ▶Page 36

The air conditioner suddenly stops operating

Case	Description / what to check
OPERATION lamp is on.	<ul style="list-style-type: none"> To protect the system, the air conditioner may stop operating after sudden large voltage fluctuations. It automatically resumes operation in about 3 minutes.
OPERATION lamp is blinking.	<ul style="list-style-type: none"> Is there anything blocking the air inlet or air outlet of the indoor unit or outdoor unit? Stop operation and after turning off the circuit breaker, remove the obstruction. Then restart operation with the remote controller. If the OPERATION lamp is still blinking, check the error code and consult your dealer. ▶Page 36 Are operation modes all the same for indoor units connected to outdoor units in the multi system? If not, set all indoor units to the same operation mode and confirm that the lamps. Moreover, when the operation mode is in AUTO, set all indoor unit operation modes to COOL or HEAT for a moment and check again that the lamps are normal. If the lamps stop blinking after the above steps, there is no malfunction. ▶Page 25

The air conditioner does not stop operating

Case	Description / what to check
The air conditioner continues operating even after operation is stopped.	<ul style="list-style-type: none"> Immediately after the air conditioner is stopped <ul style="list-style-type: none"> The outdoor unit fan continues rotating for about another 1 minute to protect the system. While the air conditioner is not in operation <ul style="list-style-type: none"> When the outdoor temperature is high, the outdoor unit fan may start rotating to protect the system.

The room does not cool down / warm up

Case	Description / what to check
Air does not come out.	<ul style="list-style-type: none"> In HEAT operation <ul style="list-style-type: none"> The air conditioner is warming up. Wait for about 1 to 4 minutes. During defrosting operation, hot air does not flow out of the indoor unit. When the air conditioner operates immediately after the circuit breaker is turned on <ul style="list-style-type: none"> The air conditioner is preparing to operate. Wait for about 3 to 20 minutes.
Air does not come out / Air comes out.	<ul style="list-style-type: none"> Is the airflow rate setting appropriate? <ul style="list-style-type: none"> Is the airflow rate setting low, such as "Indoor unit quiet" or "Airflow rate 1"? Increase the airflow rate setting. Is the set temperature appropriate? Is the adjustment of the airflow direction appropriate?
Air comes out.	<ul style="list-style-type: none"> Is there any furniture directly under or beside the indoor unit? Is the air conditioner in ECONO operation or QUIET OUTDOOR UNIT operation? ▶Page 15,16 Is the air filter dirty? Is there anything blocking the air inlet or air outlet of the indoor unit or outdoor unit? Is a window or door open? Is an exhaust fan turning?

Mist comes out

Case	Description / what to check
Mist comes out of the indoor unit.	<input checked="" type="checkbox"/> • This happens when the air in the room is cooled into mist by the cold airflow during COOL or other operation.

Remote controller

Case	Description / what to check
The unit does not receive signals from the remote controller or has a limited operating range.	<input checked="" type="checkbox"/> • The batteries may be exhausted. Replace both batteries with new dry batteries AAA.LR03 (alkaline). For details, refer to “Preparation Before Operation”. ▶Page 9 • Signal communication may be disabled if an electronic-starter-type fluorescent lamp (such as inverter-type lamps) is in the room. Consult your dealer if that is the case. • The remote controller may not function correctly if the transmitter is exposed to direct sunlight.
LCD is faint, is not working, or the display is erratic.	<input checked="" type="checkbox"/> • The batteries may be exhausted. Replace both batteries with new dry batteries AAA.LR03 (alkaline). For details, refer to “Preparation Before Operation”. ▶Page 9
Other electric devices start operating.	<input checked="" type="checkbox"/> • If the remote controller activates other electric devices, move them away or consult your dealer.

Air has an odor

Case	Description / what to check
The air conditioner gives off an odor.	<input checked="" type="checkbox"/> • The room odor absorbed in the unit is discharged with the airflow. We recommend you to have the indoor unit cleaned. Please consult your dealer.

Others

Case	Description / what to check
The air conditioner suddenly starts behaving strangely during operation.	<input type="checkbox"/> • The air conditioner may malfunction due to lightning or radio. If the air conditioner malfunctions, turn off the power with the circuit breaker and restart the operation with the remote controller.
HEAT operation cannot be selected, even though the unit is heat pump model.	<input type="checkbox"/> • Check that the jumper (J8) has not been cut. If it has been cut, contact your dealer.
The ON/OFF TIMER does not operate according to the settings.	<input checked="" type="checkbox"/> • Check if the ON/OFF TIMER and the WEEKLY TIMER are set to the same time. Change or deactivate the settings in the WEEKLY TIMER. ▶Page 19



Notes on the operating conditions

- If operation continues under any conditions other than those listed in the table,
 - A safety device may activate to stop the operation. (With a multi connection in COOL operation, the safety device may work to stop the operation of the outdoor unit only.)
 - Dew may form on the indoor unit and drip from it when COOL or DRY operation is selected.
- *1 Cutting the jumper on the outdoor unit PCB will extend the cooling operation range to 14°F (–10.0°C). Installing an air direction adjustment grille (sold separately) will further extend the operation range to –4°F (–20.0°C). Please consult your dealer.
- *2 Installing a drain pan heater (sold separately) will further extend the heating operation range to –13°F (–25.0°C). Please consult your dealer.

Mode	Operating conditions
COOL / DRY	Outdoor temperature: [MXS, MXL, MXLH models] : 14 - 115°F (–10 - 46°C) [RXL models] : 50 ^{*1} - 115°F (10 ^{*1} - 46°C) *1 –4°F (–20°C) If an air direction adjustment grille (sold separately) is installed.
	Indoor temperature : 64 - 90°F (18 - 32°C) Indoor humidity : 80% max.
	Outdoor temperature: [MXS models] : 5 - 75°F (–15 - 24°C) [MXL models] : 5 ^{*2} - 75°F (–15 ^{*2} - 24°C) [MXLH models] : –13 - 75°F (–25 - 24°C) [RXL models] : 5 ^{*2} - 75°F (–15 ^{*2} - 24°C) *2 –13°F (–25°C) If a drain pan heater (sold separately) is installed.
HEAT	Indoor temperature : 50 - 86°F (10 - 30°C)

Troubleshooting

The OPERATION lamp blinks

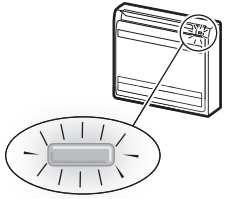

■ Check the interval time between blinks of the OPERATION lamp.

If connecting to multiple indoor units

[Blink interval of about 2 to 3 seconds]

Check the operation mode of any indoor units connected in other rooms.

Because this is a multi system air conditioner, it has one outdoor unit connected to multiple indoor units in different rooms.

If the operation mode is different from the operation mode of the indoor unit in another room, the OPERATION lamp may blink and operation may not be performed, or operation may stop while in progress.

COOL, DRY and HEAT operation may not be used at the same time.

[Blink interval of about 0.5 seconds]

This is a notification of an abnormality.

Check the error code following the procedure below, and respond according to the instructions in the table.



■ Fault diagnosis by remote controller

1. When  is held down for about 5 seconds, “00” blinks in the temperature display section.

2. While pointing the remote controller at the indoor unit, press  repeatedly.

A beep indicates a non-corresponding error code

A long beep indicates a corresponding error code

3. When a long beep is produced, check the error code and respond according to the instructions in the table.

- To cancel the code display, hold down  for about 5 seconds (the code display also clears if no button is pressed for a while).

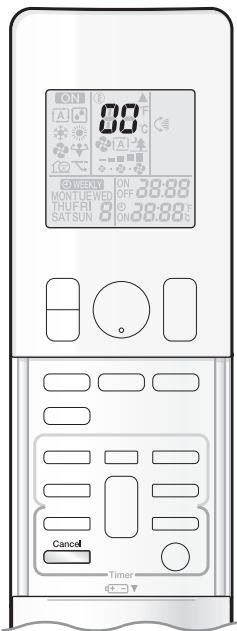

CODE	Cause	Description / what to check
E7	The fan of the outdoor unit is stopped. • Is there any foreign matter inside the outdoor unit?	After turning off the circuit breaker, remove the foreign matter, then turn the power on again and operate.
L3, L4, L5	The temperature inside the outdoor unit has become too high, so operation has stopped. • Is there anything blocking the air outlet of the outdoor unit?	After turning off the circuit breaker, remove the obstruction, then turn the power on again and operate.
Other error codes, or if the error code cannot be checked		An abnormality has occurred.

In the case of error code **U0** or **F3**

	CODE	MEANING
SYSTEM	00	NORMAL
	UA	INDOOR-OUTDOOR UNIT COMBINATION FAULT
	U0	REFRIGERANT SHORTAGE
	U2	DROP VOLTAGE OR MAIN CIRCUIT OVERVOLTAGE
	U4	FAILURE OF TRANSMISSION (BETWEEN INDOOR UNIT AND OUTDOOR UNIT)
INDOOR UNIT	A1	INDOOR PCB DEFECTIVENESS
	A5	HIGH PRESSURE CONTROL OR FREEZE-UP PROTECTOR
	A6	FAN MOTOR FAULT
	C4	FAULTY HEAT EXCHANGER TEMPERATURE SENSOR
	C9	FAULTY SUCTION AIR TEMPERATURE SENSOR
OUTDOOR UNIT	EA	COOLING-HEATING SWITCHING ERROR
	E1	CIRCUIT BOARD FAULT
	E3*	HIGH PRESSURE SWITCH (HPS) ACTIVATED
	E5	OL (COMPRESSOR OVERLOAD) STARTED / HIGH PRESSURE SWITCH (HPS) ACTIVATED*
	E6	FAULTY COMPRESSOR START UP
	E7	DC FAN MOTOR FAULT
	F3	HIGH TEMPERATURE DISCHARGE PIPE CONTROL
	F6	HIGH PRESSURE CONTROL (IN COOLING)
	H0	SENSOR FAULT
	H6	OPERATION HALT DUE TO FAULTY POSITION DETECTION SENSOR
	H8	DC CURRENT SENSOR FAULT
	H9	FAULTY SUCTION AIR TEMPERATURE SENSOR
	J3	FAULTY DISCHARGE PIPE TEMPERATURE SENSOR
	J6	FAULTY HEAT EXCHANGER TEMPERATURE SENSOR
	L3	ELECTRICAL PARTS HEAT FAULT
L4	HIGH TEMPERATURE AT INVERTER CIRCUIT HEATSINK	
L5	OUTPUT OVERCURRENT	
P4	FAULTY INVERTER CIRCUIT HEATSINK TEMPERATURE SENSOR	

*The contents of the error differ depending on the connected outdoor unit.

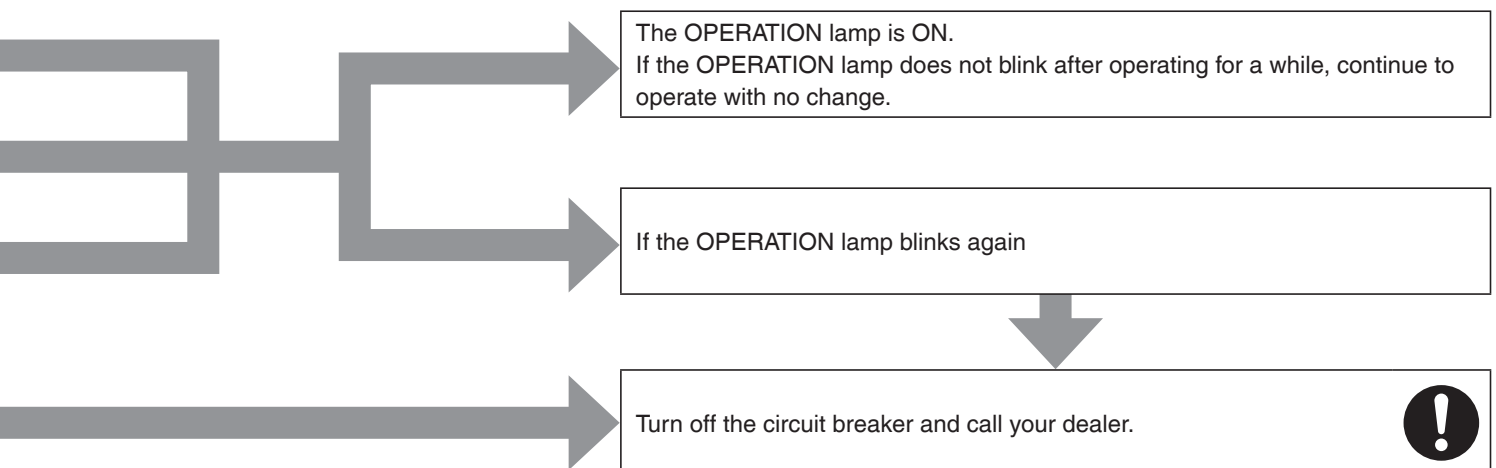

Troubleshooting

■ Call your dealer immediately

WARNING

When an abnormality (such as a burning smell) occurs, stop operation and turn off the circuit breaker.

- Continued operation in an abnormal condition may result in problems, electric shock or fire.
- Consult the dealer where you bought the air conditioner.

Do not attempt to repair or modify the air conditioner by yourself.

- Incorrect work may result in electric shock or fire.
- Consult the dealer where you bought the air conditioner.

If one of the following symptoms takes place, call your dealer immediately.

- The power cord is abnormally hot or damaged.
- An abnormal sound is heard during operation.
- The circuit breaker, a fuse, or the ground fault circuit interrupter cuts off the operation frequently.
- A switch or a button often fails to work properly.
- There is a burning smell.
- Water leaks from the indoor unit.

Turn off the circuit breaker and call your dealer.



■ After a power failure

- The air conditioner automatically resumes operation in about 3 minutes. You should just wait for a while.

■ Lightning

- If there is a risk lightning could strike in the neighborhood, stop operation and turn off the circuit breaker to protect the system.

■ Disposal requirements

- Dismantling of the unit, handling of the refrigerant, oil and other parts, should be done in accordance with the relevant local and national regulations.

MEMO

Quick Reference

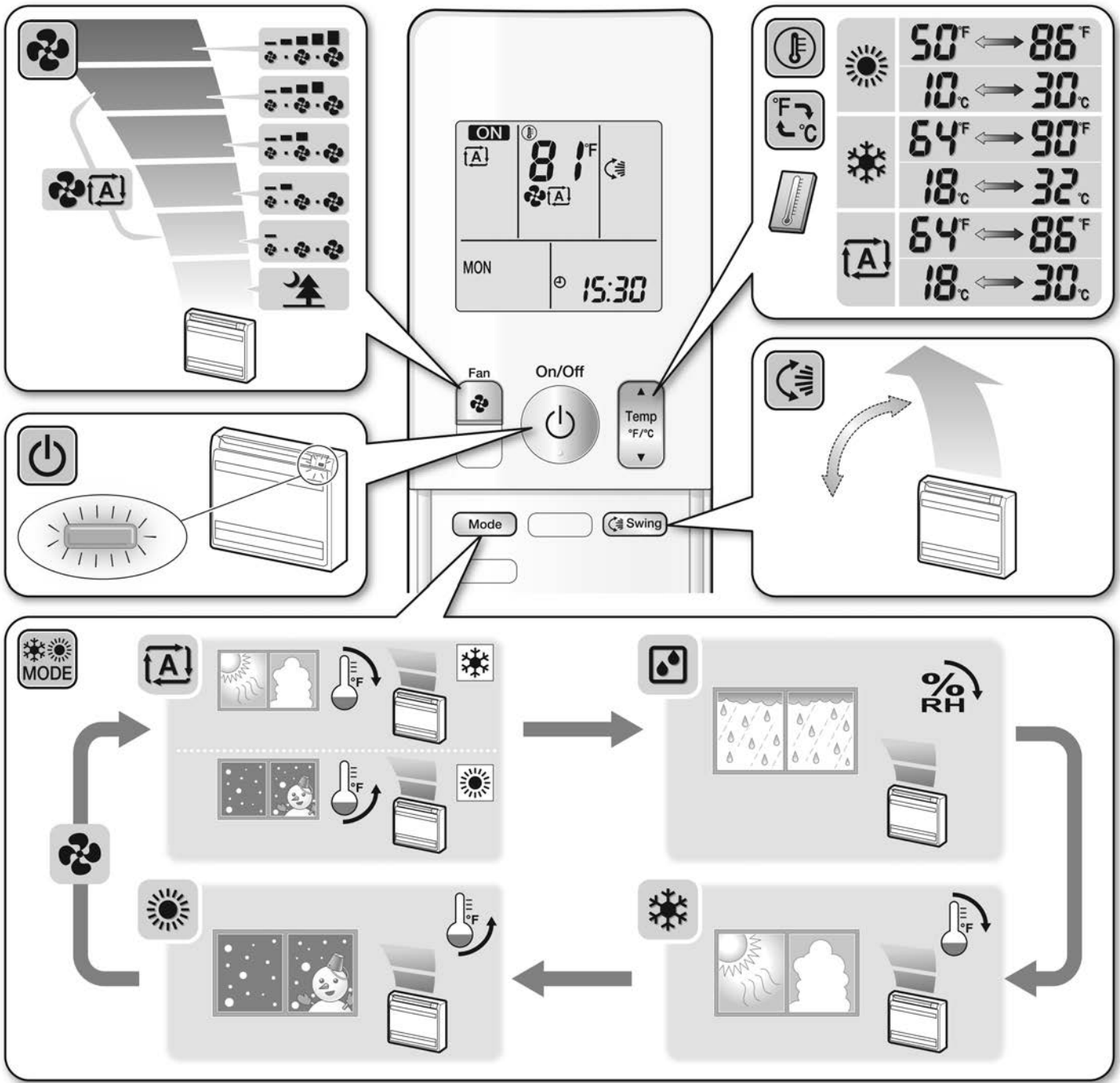

DAIKIN NORTH AMERICA LLC

19001 Kermier Road
 Houston, TX 77484
<https://www.northamerica-daikin.com/>



The two-dimensional bar code is a manufacturing code.

3P674699-1 M21B352 (2204) HT