



EDUS122402

R-32

Engineering Data

Multi-Split Type Air Conditioners
- Heat Pump -

2/3/4MXM-A, 2MXT-A, 2MXTH-A Series

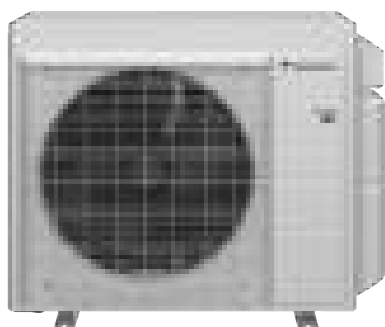

INVERTER

| | |
|---|----------------|
| Part 1 Multi-Split Type Air Conditioners | 3 |
| 1. Power Supply | 4 |
| 2. Functions | 5 |
| 2.1 Indoor unit | 5 |
| 2.2 Outdoor unit..... | 6 |
| 3. Specification | 7 |
| 3.1 Indoor unit | 7 |
| 3.2 Outdoor unit..... | 9 |
| 3.3 Combination Capacity | 12 |
| 4. Dimensions..... | 13 |
| 4.1 Indoor unit | 13 |
| 4.2 Outdoor unit..... | 16 |
| 5. Wiring Diagram..... | 18 |
| 5.1 Indoor unit | 18 |
| 5.2 Outdoor unit..... | 19 |
| 6. Piping Diagram..... | 21 |
| 6.1 Indoor unit | 21 |
| 6.2 Outdoor unit..... | 22 |
| 7. Capacity Table | 24 |
| 8. Operation Limit..... | 25 |
| 9. Sound Level | 26 |
| 9.1 Measuring Location | 26 |
| 9.2 Indoor unit | 27 |
| 9.3 Outdoor unit..... | 30 |
| 10. Electric Characteristics..... | 32 |
| Part 2 Installation Manual | 33 |
| 1. Indoor Unit..... | 34 |
| 1.1 CTXV07, FTXV09/12..... | 34 |
| 1.2 FTXV15/18/24 | 48 |
| 2. Outdoor Unit..... | 62 |
| 2.1 2/3/4MXM, 2MXT, 2MXTH | 62 |
| Part 3 Operation Manual..... | 83 |
| 1. Operation Manual List | 84 |
| 2. Operation Manual..... | 85 |
| 2.1 CTXV07, FTXV09/12..... | 85 |
| 2.2 FTXV15/18/24 | 118 |
| Part 4 Options | 151 |
| 1. Options List | 152 |

| | |
|---|-----|
| 1.1 Indoor Unit..... | 152 |
| 1.2 Outdoor Unit..... | 152 |
| 2. Control Devices | 153 |
| 2.1 <BRC073A6> Wired Remote Controller (Installation)..... | 153 |
| 2.2 <BRC073A6> Wired Remote Controller (Operation) | 182 |
| 2.3 <BRC944B2> Wired Remote Controller (Installation)..... | 225 |
| 2.4 <BRC944B2> Wired Remote Controller (Operation) | 227 |
| 2.5 <BRCW901A03/08> Wired Remote Controller Cord | 239 |
| 2.6 <KRP413BB1S> Wiring Adaptor..... | 240 |
| 2.7 <DCS302C71> Central Remote Controller (Installation) | 244 |
| 2.8 <DCS302C71> Central Remote Controller (Operation)..... | 249 |
| 2.9 <DCS301C71> Unified ON/OFF Controller (Installation)..... | 275 |
| 2.10 <DCS301C71> Unified ON/OFF Controller (Operation) | 280 |
| 2.11 <DST301BA61> Schedule Timer Controller (Installation)..... | 282 |
| 2.12 <DST301BA61> Schedule Timer Controller (Operation) | 287 |
| 2.13 <KRP928BB2S> Interface Adaptor for DIII-NET | 300 |
| 2.14 <KRP067A41> Remote Control PC-Board Set..... | 303 |
| 3. Outdoor Unit..... | 307 |
| 3.1 <KPW063B4> Air Direction Adjustment Grille..... | 307 |
| 3.2 <KKG063A44> Back Protection Wire Net..... | 309 |
| 3.3 <KEH064A41> Drain Pan Heater..... | 310 |
| 3.4 <KPS063A41> Snow Hood (Side) | 314 |
| 3.5 <KPS063A44> Snow Hood (Rear)..... | 316 |
| 3.6 <KPS063A47> Snow Hood (Discharge) | 318 |

Part 1 Multi-Split Type Air Conditioners

| | |
|------------------------------------|----|
| 1. Power Supply..... | 4 |
| 2. Functions | 5 |
| 2.1 Indoor unit..... | 5 |
| 2.2 Outdoor unit | 6 |
| 3. Specification | 7 |
| 3.1 Indoor unit..... | 7 |
| 3.2 Outdoor unit | 9 |
| 3.3 Combination Capacity..... | 12 |
| 4. Dimensions | 13 |
| 4.1 Indoor unit..... | 13 |
| 4.2 Outdoor unit | 16 |
| 5. Wiring Diagram | 18 |
| 5.1 Indoor unit..... | 18 |
| 5.2 Outdoor unit | 19 |
| 6. Piping Diagram | 21 |
| 6.1 Indoor unit..... | 21 |
| 6.2 Outdoor unit | 22 |
| 7. Capacity Table..... | 24 |
| 8. Operation Limit | 25 |
| 9. Sound Level..... | 26 |
| 9.1 Measuring Location | 26 |
| 9.2 Indoor unit..... | 27 |
| 9.3 Outdoor unit | 30 |
| 10. Electric Characteristics | 32 |

1. Power Supply

| Indoor Unit | | Outdoor Unit | Power Supply |
|---|-------------|---|-----------------------------|
| Wall Mounted Type CTXV, FTXV Series | CTXV07AVJU9 | Standard Type 2MXM18AVJU9 3MXM24AVJU9 4MXM36AVJU9 | 1 phase, 208 - 230 V, 60 Hz |
| | FTXV09AVJU9 | | |
| | FTXV12AVJU9 | | |
| | FTXV15AVJU9 | | |
| | FTXV18AVJU9 | Cold Climate Type 2MXT18AVJU9 2MXTH18AVJU9 (with drain pan heater) | |
| | FTXV24AVJU9 | | |

Note: Power Supply Intake ; Outdoor Unit



- Cautions**
1. Air conditioners should not be installed in areas where corrosive gasses, such as acid gas or alkaline gas, are produced.
 2. If the outdoor unit is to be installed close to the sea shore, direct exposure to the sea breeze should be avoided and choose an outdoor unit with anti-corrosion treatment.

2. Functions

2.1 Indoor unit

| Category | Functions | CTXV07AVJU9 FTXV09/12AVJU9 | FTXV15/18/24AVJU9 |
|---|---|-------------------------------|-------------------|
| Basic Function | Inverter (with inverter power control) | ● | ● |
| Comfortable Airflow | Power-airflow flap (horizontal blade) | ● | — |
| | Power-airflow dual flaps (horizontal blade) | — | ● |
| | Wide-angle louvers (vertical blades) | ● | ● |
| | Auto-swing (up and down) | ● | ● |
| | Auto-swing (left and right) | — | — |
| | 3-D airflow | — | — |
| | COMFORT AIRFLOW operation | ● | ● |
| Comfort Control | Auto fan speed | ● | ● |
| | Switchable fan speed | ● | ● |
| | Indoor unit quiet operation | ● | ● |
| | INTELLIGENT EYE operation | — | — |
| | 2-area INTELLIGENT EYE operation | — | — |
| | Hot-start function | ● | ● |
| Operation | Automatic cooling/heating change-over | ● | ● |
| | Program dry operation | ● | ● |
| | Fan only | ● | ● |
| Lifestyle Convenience | POWERFUL operation (inverter) | ● | ● |
| | ECONO operation | ● | ● |
| | Indoor unit ON/OFF switch | ● | ● |
| | Multi-colored indicator lamp | — | — |
| | Monitor brightness setting | — | — |
| | Signal receiving sign | ● | ● |
| | R/C with back light | ● | ● |
| Health and Cleanliness | Titanium apatite deodorizing filter | ● | ● |
| | Mold proof air filter | ● | ● |
| | Wipe-clean flat panel | ● | ● |
| | Washable grille | — | — |
| Timer | WEEKLY TIMER operation | — | — |
| | 24-hour ON/OFF TIMER | — | — |
| | Count up-down ON/OFF timer | ● | ● |
| | NIGHT SET mode | ● | ● |
| Worry Free (Reliability & Durability) | Auto-restart (after power failure) | ● | ● |
| | Self-diagnosis (R/C, LED) | ● | ● |
| Flexibility | Multi-split/split type compatible indoor unit | ● | ● |
| | Either side drain (left or right) | ● | ● |
| | °F/°C changeover R/C temperature display (factory setting: °F) | ● | ● |
| Remote Control | Remote control adaptor (normal open pulse contact) | Option | Option |
| | Remote control adaptor (normal open contact) | Option | Option |
| | DIII-NET compatible (adaptor) | Option | Option |
| | Wireless LAN connection | ● | ● |
| Remote Controller | Wireless | ● | ● |
| | Wired | Option | Option |

Notes: ●: Available

—: Not available

2.2 Outdoor unit

| Function | Standard | | Cold Climate | |
|--|-------------------|--------------------|-------------------|-------------------|
| | 2MXM | 3/4MXM | 2MXT | 2MXTH |
| Inverter (with inverter power control) | ● | ● | ● | ● |
| Operation limit | Refer to P. 25 | | | |
| PAM control | ● | ● | ● | ● |
| Standby electricity saving | — | — | — | — |
| Swing compressor | ● | ● | ● | ● |
| Reluctance DC motor | ● | ● | ● | ● |
| NIGHT QUIET mode | ● | ● | ● | ● |
| QUIET OUTDOOR UNIT operation | ● | ● | ● | ● |
| Quick warming function | — | — | — | — |
| Automatic defrosting | ● | ● | ● | ● |
| Defrost learning control | — | — | — | — |
| Priority room setting | ● | ● | ● | ● |
| COOL/HEAT mode lock | ● | ● | ● | ● |
| Self-diagnosis (R/C, LED) | ● | ● | ● | ● |
| Wiring error check function | ● | ● | ● | ● |
| Anti-corrosion treatment of outdoor heat exchanger | ● | ● | ● | ● |
| Drain pan heater | Option | Option | Option | ● |
| Drain pan heater control by microcomputer | ● | ● | ● | ● |
| Chargeless | 98.4 ft (30 m) | 131.2 ft (40 m) | 98.4 ft (30 m) | 98.4 ft (30 m) |
| Low temp. cooling operation (−15°C) (5°F) | — | — | — | — |

Notes: ●: Available
 —: Not available

3. Specification

3.1 Indoor unit

| Model | | | CTXV07AVJU9 | | FTXV09AVJU9 | |
|---------------------------------|----------------|-----------------|---|-------------------|---|-------------------|
| | | | Cooling | Heating | Cooling | Heating |
| Power Supply | | Phase | 1φ | | 1φ | |
| | | Hz, V | 60 Hz, 208 - 230 V | | 60 Hz, 208 - 230 V | |
| Rated Capacity | | | 7 kBtu/h Class | | 9 kBtu/h Class | |
| Front Panel Color (Munsell No.) | | | White (N9.5) | | White (N9.5) | |
| Airflow Rates | H | cfm (m³/min) | 332 (9.4) | 332 (9.4) | 381 (10.8) | 385 (10.9) |
| | M | | 268 (7.6) | 279 (7.9) | 272 (7.7) | 304 (8.6) |
| | L | | 230 (6.5) | 230 (6.5) | 230 (6.5) | 230 (6.5) |
| | SL | | 166 (4.7) | 194 (5.5) | 166 (4.7) | 194 (5.5) |
| Fan | Type | | Cross Flow Fan | | Cross Flow Fan | |
| | Drive Input | A | 0.20 | | 0.20 | |
| | Speed | Steps | 5 Steps, Quiet, Auto | | 5 Steps, Quiet, Auto | |
| Air Direction Control | | | Right, Left, Horizontal, Downward | | Right, Left, Horizontal, Downward | |
| Air Filter | | | Removable, Washable | | Removable, Washable | |
| Running Current (Rated) | | A | 0.11 - 0.10 | 0.12 - 0.11 | 0.14 - 0.13 | 0.13 - 0.12 |
| Power Consumption (Rated) | | W | 20 - 20 | 23 - 23 | 26 - 26 | 25 - 25 |
| Power Factor (Rated) | | % | 87.0 - 90.3 | 94.0 - 91.3 | 90.4 - 86.2 | 90.9 - 87.3 |
| Temperature Control | | | Microcomputer Control | | Microcomputer Control | |
| Dimensions (H × W × D) | | in. (mm) | 11-1/4 × 30-5/16 × 8-3/4 (286 × 770 × 223) | | 11-1/4 × 30-5/16 × 8-3/4 (286 × 770 × 223) | |
| Packaged Dimensions (H × W × D) | | in. (mm) | 12-5/8 × 32-11/16 × 14-3/16 (320 × 830 × 360) | | 12-5/8 × 32-11/16 × 14-3/16 (320 × 830 × 360) | |
| Weight (Mass) | | lbs (kg) | 19 (9) | | 19 (9) | |
| Gross Weight (Gross Mass) | | lbs (kg) | 24 (11) | | 24 (11) | |
| Sound Pressure Level | H / M / L / SL | dB(A) | 40 / 35 / 31 / 24 | 39 / 34 / 28 / 25 | 43 / 35 / 31 / 24 | 41 / 35 / 28 / 25 |
| Heat Insulation | | | Both Liquid and Gas Pipes | | Both Liquid and Gas Pipes | |
| Piping Connection | Liquid | in. (mm) | φ 1/4 (φ 6.4) | | φ 1/4 (φ 6.4) | |
| | Gas | in. (mm) | φ 3/8 (φ 9.5) | | φ 3/8 (φ 9.5) | |
| | Drain | in. (mm) | φ 5/8 (φ 16) | | φ 5/8 (φ 16) | |
| Drawing No. | | | 3D153215A | | 3D153215A | |
| Note | | | SL: The quiet fan level of the airflow rate setting | | SL: The quiet fan level of the airflow rate setting | |

| Model | | | FTXV12AVJU9 | | FTXV15AVJU9 | |
|---------------------------------|----------------|-----------------|---|-------------------|---|-------------------|
| | | | Cooling | Heating | Cooling | Heating |
| Power Supply | | Phase | 1φ | | 1φ | |
| | | Hz, V | 60 Hz, 208 - 230 V | | 60 Hz, 208 - 230 V | |
| Rated Capacity | | | 12 kBtu/h Class | | 15 kBtu/h Class | |
| Front Panel Color (Munsell No.) | | | White (N9.5) | | White (N9.5) | |
| Airflow Rates | H | cfm (m³/min) | 392 (11.1) | 438 (12.4) | 540 (15.3) | 636 (18.0) |
| | M | | 293 (8.3) | 318 (9.0) | 470 (13.3) | 537 (15.2) |
| | L | | 226 (6.4) | 240 (6.8) | 381 (10.8) | 452 (12.8) |
| | SL | | 166 (4.7) | 205 (5.8) | 339 (9.6) | 388 (11.0) |
| Fan | Type | | Cross Flow Fan | | Cross Flow Fan | |
| | Drive Input | A | 0.23 | | 0.31 | |
| | Speed | Steps | 5 Steps, Quiet, Auto | | 5 Steps, Quiet, Auto | |
| Air Direction Control | | | Right, Left, Horizontal, Downward | | Right, Left, Horizontal, Downward | |
| Air Filter | | | Removable, Washable | | Removable, Washable | |
| Running Current (Rated) | | A | 0.17 - 0.15 | 0.20 - 0.18 | 0.19 - 0.17 | 0.20 - 0.18 |
| Power Consumption (Rated) | | W | 29 - 29 | 35 - 35 | 36 - 36 | 39 - 39 |
| Power Factor (Rated) | | % | 81.3 - 84.7 | 83.7 - 82.7 | 91.1 - 93.5 | 93.8 - 92.3 |
| Temperature Control | | | Microcomputer Control | | Microcomputer Control | |
| Dimensions (H × W × D) | | in. (mm) | 11-1/4 × 30-5/16 × 8-3/4 (286 × 770 × 223) | | 11-5/8 × 39 × 10-3/8 (295 × 990 × 263) | |
| Packaged Dimensions (H × W × D) | | in. (mm) | 12-5/8 × 32-11/16 × 14-3/16 (320 × 830 × 360) | | 15-3/16 × 43-3/8 × 15-5/16 (386 × 1,102 × 389) | |
| Weight (Mass) | | lbs (kg) | 19 (9) | | 27 (13) | |
| Gross Weight (Gross Mass) | | lbs (kg) | 24 (11) | | 37 (17) | |
| Sound Pressure Level | H / M / L / SL | dB(A) | 45 / 37 / 31 / 24 | 45 / 37 / 30 / 26 | 45 / 41 / 36 / 33 | 45 / 41 / 37 / 33 |
| Heat Insulation | | | Both Liquid and Gas Pipes | | Both Liquid and Gas Pipes | |
| Piping Connection | Liquid | in. (mm) | φ 1/4 (φ 6.4) | | φ 1/4 (φ 6.4) | |
| | Gas | in. (mm) | φ 3/8 (φ 9.5) | | φ 1/2 (φ 12.7) | |
| | Drain | in. (mm) | φ 5/8 (φ 16) | | φ 5/8 (φ 16) | |
| Drawing No. | | | 3D153215A | | 3D153178A | |
| Note | | | SL: The quiet fan level of the airflow rate setting | | SL: The quiet fan level of the airflow rate setting | |

| |
|---------------------|
| Conversion Formulae |
| kcal/h = kW × 860 |
| Btu/h = kW × 3412 |
| cfm = m³/min × 35.3 |

| Model | | | FTXV18AVJU9 | | FTXV24AVJU9 | |
|---------------------------------|----------------|------------------------------|---|-------------------|---|-------------------|
| | | | Cooling | Heating | Cooling | Heating |
| Power Supply | | Phase | 1 ϕ | | 1 ϕ | |
| | | Hz, V | 60 Hz, 208 - 230 V | | 60 Hz, 208 - 230 V | |
| Rated Capacity | | | 18 kBtu/h Class | | 24 kBtu/h Class | |
| Front Panel Color (Munsell No.) | | | White (N9.5) | | White (N9.5) | |
| Airflow Rates | H | cfm (m ³ /min) | 565 (16.0) | 717 (20.3) | 629 (17.8) | 717 (20.3) |
| | M | | 463 (13.1) | 572 (16.2) | 501 (14.2) | 572 (16.2) |
| | L | | 378 (10.7) | 452 (12.8) | 378 (10.7) | 466 (13.2) |
| | SL | | 335 (9.5) | 388 (11.0) | 335 (9.5) | 413 (11.7) |
| Fan | Type | | Cross Flow Fan | | Cross Flow Fan | |
| | Drive Input | A | 0.40 | | 0.45 | |
| | Speed | Steps | 5 Steps, Quiet, Auto | | 5 Steps, Quiet, Auto | |
| Air Direction Control | | | Right, Left, Horizontal, Downward | | Right, Left, Horizontal, Downward | |
| Air Filter | | | Removable, Washable | | Removable, Washable | |
| Running Current (Rated) | | A | 0.20 - 0.18 | 0.29 - 0.26 | 0.31 - 0.28 | 0.30 - 0.27 |
| Power Consumption (Rated) | | W | 39 - 39 | 54 - 54 | 57 - 57 | 55 - 55 |
| Power Factor (Rated) | | % | 93.8 - 92.5 | 89.5 - 89.3 | 88.4 - 88.7 | 88.1 - 89.3 |
| Temperature Control | | | Microcomputer Control | | Microcomputer Control | |
| Dimensions (H x W x D) | | in. (mm) | 11-5/8 x 39 x 10-3/8 (295 x 990 x 263) | | 11-5/8 x 39 x 10-3/8 (295 x 990 x 263) | |
| Packaged Dimensions (H x W x D) | | in. (mm) | 15-3/16 x 43-3/8 x 15-5/16 (386 x 1,102 x 389) | | 15-3/16 x 43-3/8 x 15-5/16 (386 x 1,102 x 389) | |
| Weight (Mass) | | lbs (kg) | 27 (13) | | 27 (13) | |
| Gross Weight (Gross Mass) | | lbs (kg) | 37 (17) | | 37 (17) | |
| Sound Pressure Level | H / M / L / SL | dB(A) | 48 / 43 / 38 / 33 | 49 / 42 / 37 / 33 | 52 / 45 / 39 / 34 | 49 / 43 / 38 / 34 |
| Heat Insulation | | | Both Liquid and Gas Pipes | | Both Liquid and Gas Pipes | |
| Piping Connection | Liquid | in. (mm) | ϕ 1/4 (ϕ 6.4) | | ϕ 1/4 (ϕ 6.4) | |
| | Gas | in. (mm) | ϕ 1/2 (ϕ 12.7) | | ϕ 5/8 (ϕ 15.9) | |
| | Drain | in. (mm) | ϕ 5/8 (ϕ 16) | | ϕ 5/8 (ϕ 16) | |
| Drawing No. | | | 3D153178A | | 3D153178A | |
| Note | | | SL: The quiet fan level of the airflow rate setting | | SL: The quiet fan level of the airflow rate setting | |

| Conversion Formulae |
|----------------------------------|
| kcal/h = kW x 860 |
| Btu/h = kW x 3412 |
| cfm = m ³ /min x 35.3 |

3.2 Outdoor unit

| Model | 2MXM18AVJU9 | | | | 3MXM24AVJU9 | | | | |
|-------------------------------------|---------------------|--|---------|--|-------------|--|---------|--|--|
| | Cooling | | Heating | | Cooling | | Heating | | |
| Power Supply | Phase | 1φ | | | | 1φ | | | |
| | Hz, V | 60 Hz, 208 - 230 V | | | | 60 Hz, 208 - 230 V | | | |
| COP@5°F | W/W | — | | 1.8 | | — | | 1.8 | |
| EER2 | Btu/W-h | 12.0 | | — | | 12.0 | | — | |
| SEER2 | | 21.0 | | — | | 21.0 | | — | |
| HSPF2 | | — | | 10.0 | | — | | 10.0 | |
| Casing Color | | Ivory White | | | | Ivory White | | | |
| Compressor | Type | Hermetically Sealed Swing Type | | | | Hermetically Sealed Swing Type | | | |
| | Model | 2Y147BKBX1A | | | | 2Y260BPAX1A | | | |
| | Motor Output | W | | 1,300 | | 2,400 | | | |
| Refrigerant Oil | Model | FW68DA | | | | FW68DA | | | |
| | Charge | fl oz (L) | | 22.0 (0.65) | | 30.4 (0.9) | | | |
| Refrigerant | Type | R-32 | | | | R-32 | | | |
| | Charge | lbs (kg) | | 3.3 (1.50) | | 4.9 (2.2) | | | |
| Airflow Rates | cfm | 2,112 | | 2,140 | | 2,055 | | 2,140 | |
| | m ³ /min | 59.8 | | 60.6 | | 58.2 | | 60.6 | |
| Fan | Type | Propeller | | | | Propeller | | | |
| | Motor Output | W | | 150 | | 150 | | | |
| | Running Current | A | | 0.31 | | 0.29 | | 0.33 | |
| | Power Consumption | W | | 65.4 | | 61.0 | | 67.7 | |
| Starting Current | A | 14.0 | | | | 17.0 | | | |
| Dimensions (H × W × D) | in. (mm) | 29-1/2 × 34-1/4 × 12-5/8 (750 × 870 × 320) | | | | 29-1/2 × 34-1/4 × 12-5/8 (750 × 870 × 320) | | | |
| Packaged Dimensions (H × W × D) | in. (mm) | 32-1/16 × 40-5/16 × 16 (814 × 1,024 × 406) | | | | 32-1/16 × 40-5/16 × 16 (814 × 1,024 × 406) | | | |
| Weight (Mass) | lbs (kg) | 127 (58) | | | | 140 (64) | | | |
| Gross Weight (Gross Mass) | lbs (kg) | 135 (61) | | | | 148 (67) | | | |
| Sound Pressure Level | dB(A) | 52 | | 54 | | 52 | | 54 | |
| Piping Connection | Liquid | in. (mm) | | φ 1/4 × 2 (φ 6.4 × 2) | | φ 1/4 × 3 (φ 6.4 × 3) | | | |
| | Gas | in. (mm) | | φ 3/8 × 1, φ 1/2 × 1 (φ 9.5 × 1, φ 12.7 × 1) | | φ 3/8 × 1, φ 1/2 × 2 (φ 9.5 × 1, φ 12.7 × 2) | | | |
| | Drain | in. (mm) | | I.D. φ 5/8 (φ 15.9) | | I.D. φ 5/8 (φ 15.9) | | | |
| Heat Insulation | | Both Liquid and Gas Pipes | | | | Both Liquid and Gas Pipes | | | |
| No. of Wiring Connections | | 3 for Power Supply, 4 for Interunit Wiring (Including Ground Wiring) | | | | 3 for Power Supply, 4 for Interunit Wiring (Including Ground Wiring) | | | |
| Max. Interunit Piping Length | ft (m) | 164 (50) (for Total of Each Room) | | | | 230 (70) (for Total of Each Room) | | | |
| | ft (m) | 82 (25) (for One Room) | | | | 82 (25) (for One Room) | | | |
| Amount of Additional Charge | oz/ft (g/m) | 0.22 (20) (98-3/8 ft (30 m) or more) | | | | 0.22 (20) (131-1/4 ft (40 m) or more) | | | |
| Max. Installation Height Difference | ft (m) | 49-1/4 (15) (Between Indoor Unit and Outdoor Unit) | | | | 49-1/4 (15) (Between Indoor Unit and Outdoor Unit) | | | |
| | ft (m) | 24-5/8 (7.5) (Between Indoor Units) | | | | 24-5/8 (7.5) (Between Indoor Units) | | | |
| Conditions Based on | | Indoor ; 80°FDB (26.7°CDB) / 67°FWB (19.4°CWB) | | Indoor ; 70°FDB (21°CDB) / 60°FWB (15.6°CWB) | | Indoor ; 80°FDB (26.7°CDB) / 67°FWB (19.4°CWB) | | Indoor ; 70°FDB (21°CDB) / 60°FWB (15.6°CWB) | |
| | | Outdoor ; 95°FDB (35°CDB) / 75°FWB (24°CWB) | | Outdoor ; 47°FDB (8.3°CDB) / 43°FWB (6°CWB) | | Outdoor ; 95°FDB (35°CDB) / 75°FWB (24°CWB) | | Outdoor ; 47°FDB (8.3°CDB) / 43°FWB (6°CWB) | |
| Drawing No. | | Piping length: 25 ft (7.5 m) 3D151521A | | | | Piping length: 25 ft (7.5 m) 3D152057A | | | |

| Conversion Formulae |
|----------------------------------|
| kcal/h = kW × 860 |
| Btu/h = kW × 3412 |
| cfm = m ³ /min × 35.3 |

| Model | | | 4MXM36AVJU9 | | |
|-------------------------------------|---------------------|-----------|--|--|--|
| | | | Cooling | | Heating |
| Power Supply | Phase | | 1 ϕ | | |
| | Hz, V | | 60 Hz, 208 - 230 V | | |
| COP@5°F | W/W | | — | | 1.8 |
| EER2 | Btu/W·h | | 10.0 | | — |
| SEER2 | | | 20.0 | | — |
| HSPF2 | | | — | | 9.5 |
| Casing Color | | | Ivory White | | |
| Compressor | Type | | Hermetically Sealed Swing Type | | |
| | Model | | 2Y260BPAX1A | | |
| | Motor Output | W | 2,400 | | |
| Refrigerant Oil | Model | | FW68DA | | |
| | Charge | fl oz (L) | 30.4 (0.9) | | |
| Refrigerant | Type | | R-32 | | |
| | Charge | lbs (kg) | 4.9 (2.2) | | |
| Airflow Rates | cfm | | 2,402 | | 2,518 |
| | m ³ /min | | 68.0 | | 71.3 |
| Fan | Type | | Propeller | | |
| | Motor Output | W | 150 | | |
| | Running Current | A | 0.44 | | 0.49 |
| | Power Consumption | W | 90.9 | | 102.7 |
| Starting Current | A | | 18.5 | | |
| Dimensions (H × W × D) | in. (mm) | | 29-1/2 × 34-1/4 × 12-5/8 (750 × 870 × 320) | | |
| Packaged Dimensions (H × W × D) | in. (mm) | | 32-1/16 × 40-5/16 × 16 (814 × 1,024 × 406) | | |
| Weight (Mass) | lbs (kg) | | 142 (65) | | |
| Gross Weight (Gross Mass) | lbs (kg) | | 150 (68) | | |
| Sound Pressure Level | dB(A) | | 56 | | 60 |
| Piping Connection | Liquid | in. (mm) | ϕ 1/4 × 4 (ϕ 6.4 × 4) | | |
| | Gas | in. (mm) | ϕ 3/8 × 1, ϕ 1/2 × 2, ϕ 5/8 × 1 (ϕ 9.5 × 1, ϕ 12.7 × 2, ϕ 15.9 × 1) | | |
| | Drain | in. (mm) | I.D. ϕ 5/8 (ϕ 15.9) | | |
| Heat Insulation | | | Both Liquid and Gas Pipes | | |
| No. of Wiring Connections | | | 3 for Power Supply, 4 for Interunit Wiring (Including Ground Wiring) | | |
| Max. Interunit Piping Length | ft (m) | | 230 (70) (for Total of Each Room) | | |
| | ft (m) | | 82 (25) (for One Room) | | |
| Amount of Additional Charge | oz/ft (g/m) | | 0.22 (20) (131-1/4 ft (40 m) or more) | | |
| Max. Installation Height Difference | ft (m) | | 49-1/4 (15) (Between Indoor Unit and Outdoor Unit) | | |
| | ft (m) | | 24-5/8 (7.5) (Between Indoor Units) | | |
| Conditions Based on | | | Indoor ; 80°FDB (26.7°CDB) / 67°FWB (19.4°CWB) | | Indoor ; 70°FDB (21°CDB) / 60°FWB (15.6°CWB) |
| | | | Outdoor ; 95°FDB (35°CDB) / 75°FWB (24°CWB) | | Outdoor ; 47°FDB (8.3°CDB) / 43°FWB (6°CWB) |
| Drawing No. | | | Piping length: 25 ft (7.5 m) 3D151522A | | |

| Conversion Formulae |
|----------------------------------|
| kcal/h = kW × 860 |
| Btu/h = kW × 3412 |
| cfm = m ³ /min × 35.3 |

| Model | 2MXT18AVJU9 | | | | 2MXTH18AVJU9 | | | | |
|-------------------------------------|---------------------|--|---------|---|--------------|--|---------|--|--|
| | Cooling | | Heating | | Cooling | | Heating | | |
| Power Supply | Phase | 1 ϕ | | | | 1 ϕ | | | |
| | Hz, V | 60 Hz, 208 - 230 V | | | | 60 Hz, 208 - 230 V | | | |
| COP@5°F | W/W | — | | 1.8 | | — | | 1.8 | |
| EER2 | Btu/W·h | 12.0 | | — | | 12.0 | | — | |
| SEER2 | | 21.0 | | — | | 21.0 | | — | |
| HSPF2 | | — | | 10.0 | | — | | 10.0 | |
| Casing Color | | Ivory White | | | | Ivory White | | | |
| Compressor | Type | Hermetically Sealed Swing Type | | | | Hermetically Sealed Swing Type | | | |
| | Model | 2Y260BPAX1A | | | | 2Y260BPAX1A | | | |
| | Motor Output | W | | 2,400 | | 2,400 | | | |
| Refrigerant Oil | Model | FW68DA | | | | FW68DA | | | |
| | Charge | fl oz (L) | | 30.4 (0.9) | | 30.4 (0.9) | | | |
| Refrigerant | Type | R-32 | | | | R-32 | | | |
| | Charge | lbs (kg) | | 4.9 (2.2) | | 4.9 (2.2) | | | |
| Airflow Rates | cfm | 2,112 | | 2,140 | | 2,112 | | 2,140 | |
| | m ³ /min | 59.8 | | 60.6 | | 59.8 | | 60.6 | |
| Fan | Type | Propeller | | | | Propeller | | | |
| | Motor Output | W | | 150 | | 150 | | | |
| | Running Current | A | | 0.31 | | 0.31 | | 0.33 | |
| | Power Consumption | W | | 65.4 | | 65.4 | | 67.7 | |
| Starting Current | A | 17.0 | | | | 17.0 | | | |
| Dimensions (H × W × D) | in. (mm) | 29-1/2 × 34-1/4 × 12-5/8 (750 × 870 × 320) | | | | 29-1/2 × 34-1/4 × 12-5/8 (750 × 870 × 320) | | | |
| Packaged Dimensions (H × W × D) | in. (mm) | 32-1/16 × 40-5/16 × 16 (814 × 1,024 × 406) | | | | 32-1/16 × 40-5/16 × 16 (814 × 1,024 × 406) | | | |
| Weight (Mass) | lbs (kg) | 139 (63) | | | | 140 (64) | | | |
| Gross Weight (Gross Mass) | lbs (kg) | 147 (67) | | | | 148 (67) | | | |
| Sound Pressure Level | dB(A) | 52 | | 54 | | 52 | | 54 | |
| Piping Connection | Liquid | in. (mm) | | ϕ 1/4 × 2 (ϕ 6.4 × 2) | | ϕ 1/4 × 2 (ϕ 6.4 × 2) | | | |
| | Gas | in. (mm) | | ϕ 3/8 × 1, ϕ 1/2 × 1 (ϕ 9.5 × 1, ϕ 12.7 × 1) | | ϕ 3/8 × 1, ϕ 1/2 × 1 (ϕ 9.5 × 1, ϕ 12.7 × 1) | | | |
| | Drain | in. (mm) | | I.D. ϕ 5/8 (ϕ 15.9) | | I.D. ϕ 5/8 (ϕ 15.9) | | | |
| Heat Insulation | | Both Liquid and Gas Pipes | | | | Both Liquid and Gas Pipes | | | |
| No. of Wiring Connections | | 3 for Power Supply, 4 for Interunit Wiring (Including Ground Wiring) | | | | 3 for Power Supply, 4 for Interunit Wiring (Including Ground Wiring) | | | |
| Max. Interunit Piping Length | ft (m) | 164 (50) (for Total of Each Room) | | | | 164 (50) (for Total of Each Room) | | | |
| | ft (m) | 82 (25) (for One Room) | | | | 82 (25) (for One Room) | | | |
| Amount of Additional Charge | oz/ft (g/m) | 0.22 (20) (98-3/8 ft (30 m) or more) | | | | 0.22 (20) (98-3/8 ft (30 m) or more) | | | |
| Max. Installation Height Difference | ft (m) | 49-1/4 (15) (Between Indoor Unit and Outdoor Unit) | | | | 49-1/4 (15) (Between Indoor Unit and Outdoor Unit) | | | |
| | ft (m) | 24-5/8 (7.5) (Between Indoor Units) | | | | 24-5/8 (7.5) (Between Indoor Units) | | | |
| Conditions Based on | | Indoor : 80°FDB (26.7°CDB) / 67°FWB (19.4°CWB) | | Indoor : 70°FDB (21°CDB) / 60°FWB (15.6°CWB) | | Indoor : 80°FDB (26.7°CDB) / 67°FWB (19.4°CWB) | | Indoor : 70°FDB (21°CDB) / 60°FWB (15.6°CWB) | |
| | | Outdoor : 95°FDB (35°CDB) / 75°FWB (24°CWB) | | Outdoor : 47°FDB (8.3°CDB) / 43°FWB (6°CWB) | | Outdoor : 95°FDB (35°CDB) / 75°FWB (24°CWB) | | Outdoor : 47°FDB (8.3°CDB) / 43°FWB (6°CWB) | |
| Drawing No. | | Piping length: 25 ft (7.5 m) 3D152058A | | | | Piping length: 25 ft (7.5 m) 3D151523A | | | |

| Conversion Formulae |
|----------------------------------|
| kcal/h = kW × 860 |
| Btu/h = kW × 3412 |
| cfm = m ³ /min × 35.3 |

3.3 Combination Capacity

Refer to Engineering Data books below for the Combination Capacity.

| Type | Model Name | Reference |
|-------------------|---|------------|
| Standard type | 2MXM18AVJU9 3MXM24AVJU9 4MXM36AVJU9 | EDUS122403 |
| Cold climate type | 2MXT18AVJU9 2MXTH18AVJU9 | EDUS122404 |

4. Dimensions

4.1 Indoor unit

CTXV07AVJU9, FTXV09/12AVJU9

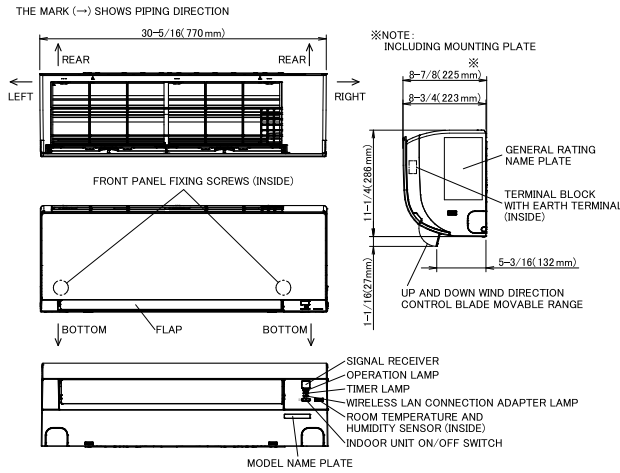

REQUIRED SPACE

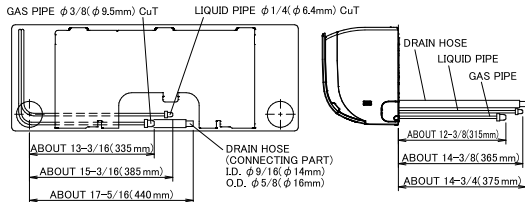
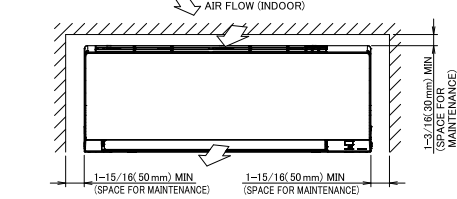

WIRELESS REMOTE CONTROLLER (ARC480A83)

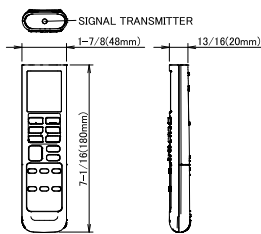

BLADE ANGLE

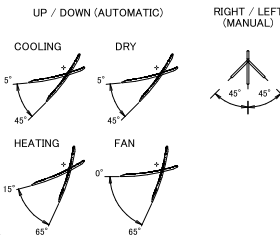

STANDARD LOCATIONS OF WALL HOLES

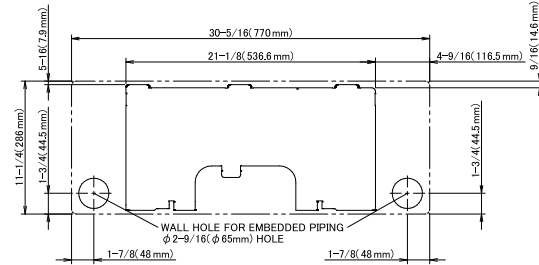

3D150958A

FTXV15/18AVJU9

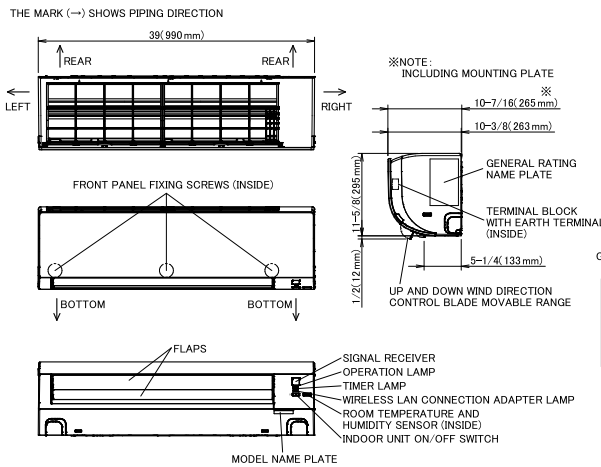

REQUIRED SPACE

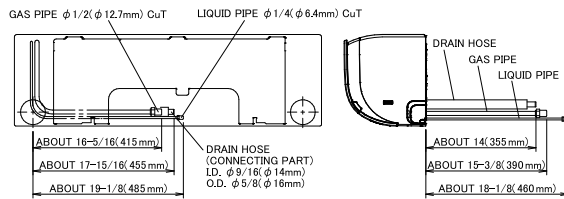
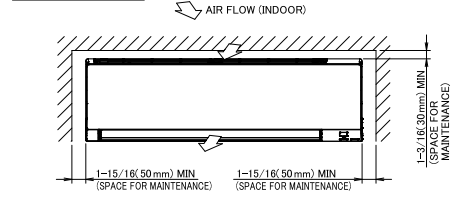

WIRELESS REMOTE CONTROLLER (ARC480A83)

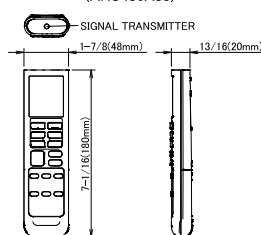

BLADE ANGLE

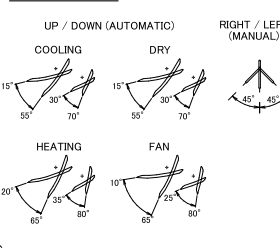

STANDARD LOCATIONS OF WALL HOLES

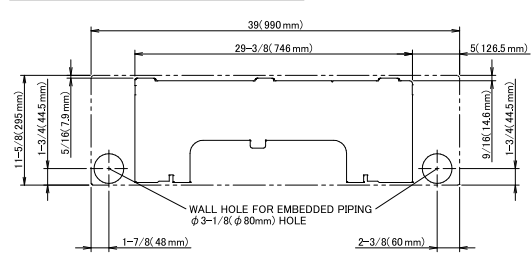

3D150966A

FTXV24AVJU9

THE MARK (→) SHOWS PIPING DIRECTION

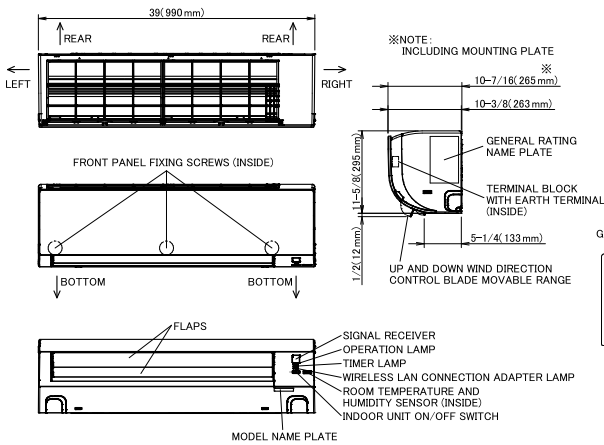

REQUIRED SPACE

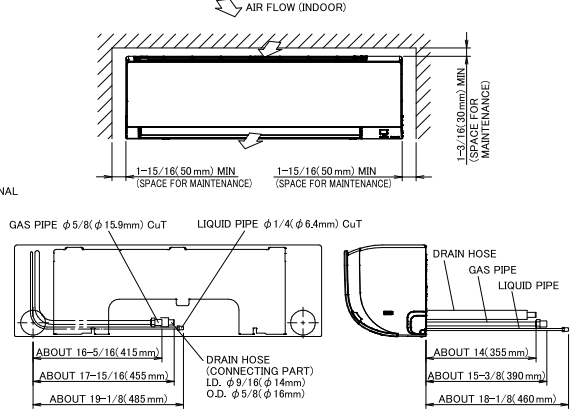

WIRELESS REMOTE CONTROLLER (ARC480A83)

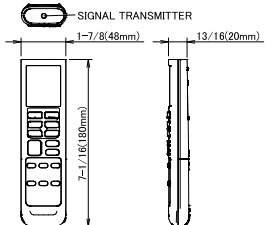

BLADE ANGLE

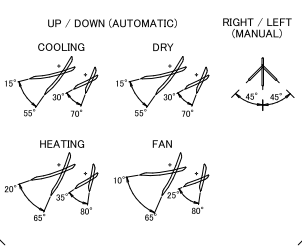

STANDARD LOCATIONS OF WALL HOLES

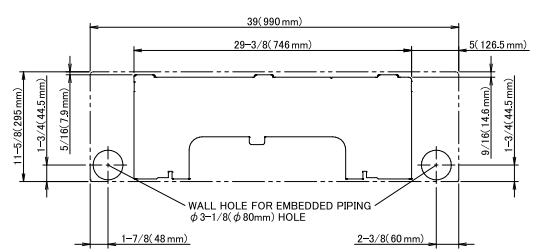

3D150967A

BRC073A6 — Wired Remote Controller (Option) —

REMOTE CONTROLLER DIMENSIONS

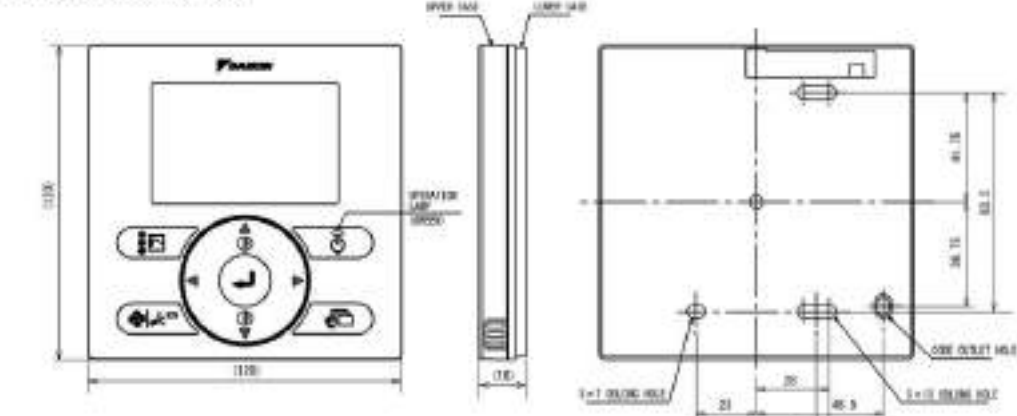

DIMENSION OF THE STRAP SIZE FOR THE REMOTE CONTROLLER ADAPTER USE

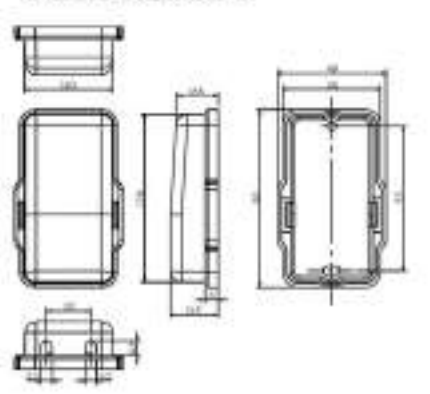

REMOTE CONTROLLER CORD (4-WIRE) (OPTIONAL ACCESSORIES)

| PART No. | LENGTH |
|-----------|--------|
| BR0901A03 | 2m |
| BR0901A02 | 6m |

3D152615

BRC944B2 — Wired Remote Controller (Option) —

* REMOTE CONTROLLER DIMENSIONS

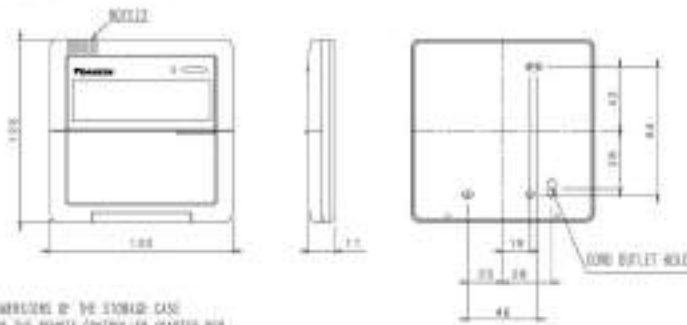

NOTE 1, REMOTE CONTROLLER CORD AND STAPLE ARE NOT ATTACHED.
 2, ROOM TEMPERATURE THERMISTOR IS NOT ATTACHED.

REMOTE CONTROLLER CORD (4-WIRE) OPTIONAL ACCESSORIES

| PART NO. | LENGTH |
|----------|--------|
| RMK944B | 2M |
| RMK944B | 3M |

* DIMENSIONS OF THE STORAGE CASE FOR THE REMOTE CONTROLLER ADAPTER PCB

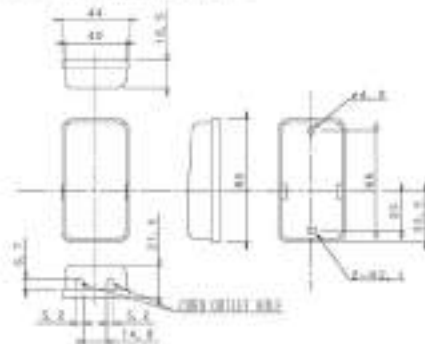

* INSTALLATION METHOD

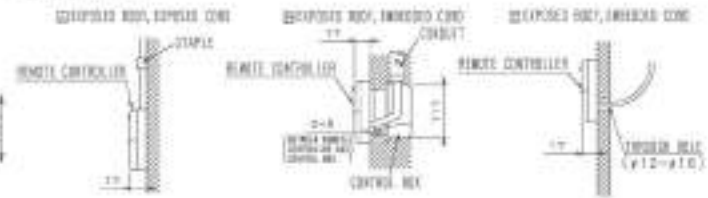

3D062374

4.2 Outdoor unit
2MXM18AVJU9, 2MXT18AVJU9, 2MXTH18AVJU9

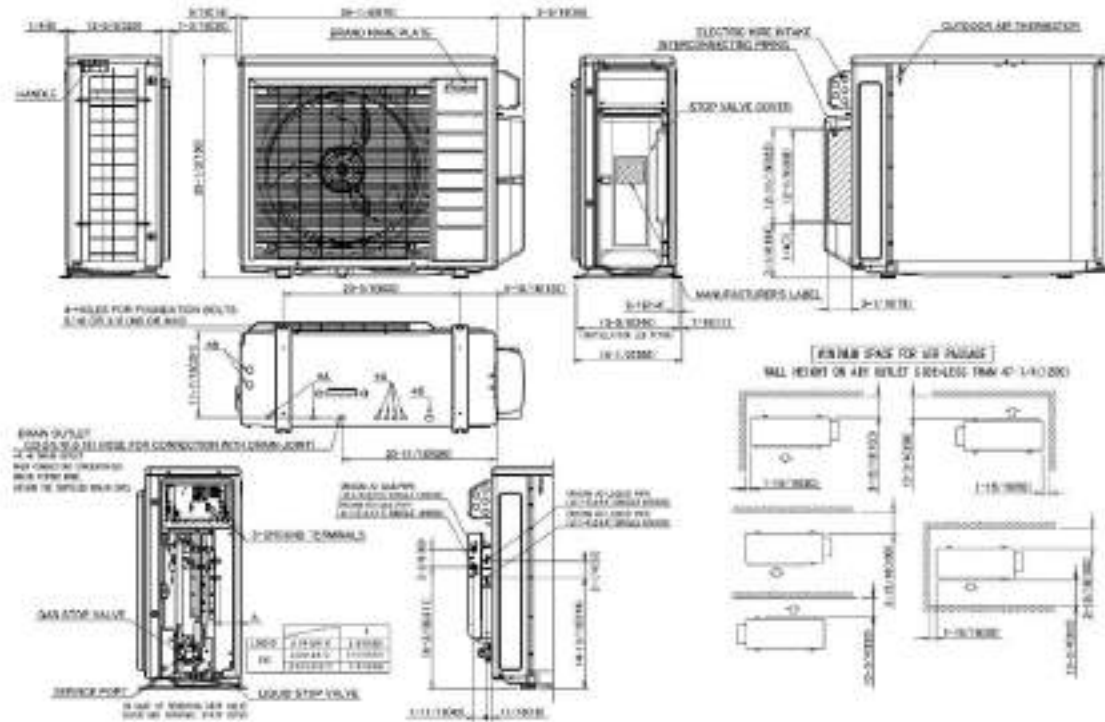

3D149807

3MXM24AVJU9

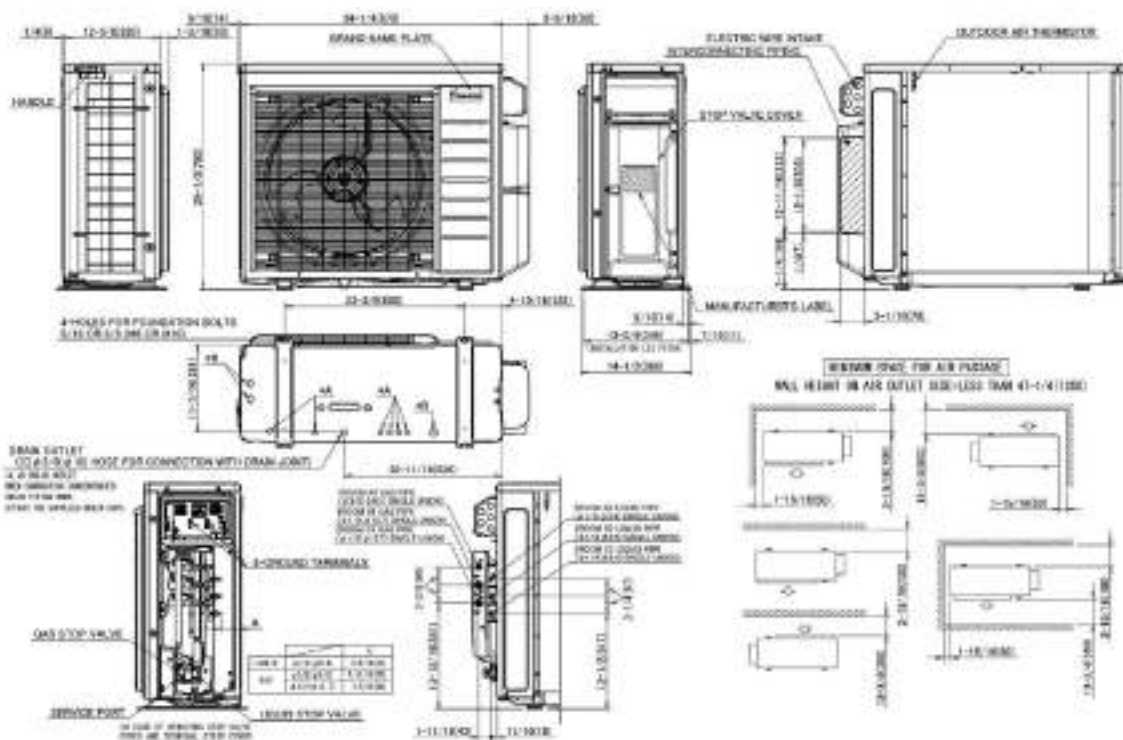

3D149808

4MXM36AVJU9

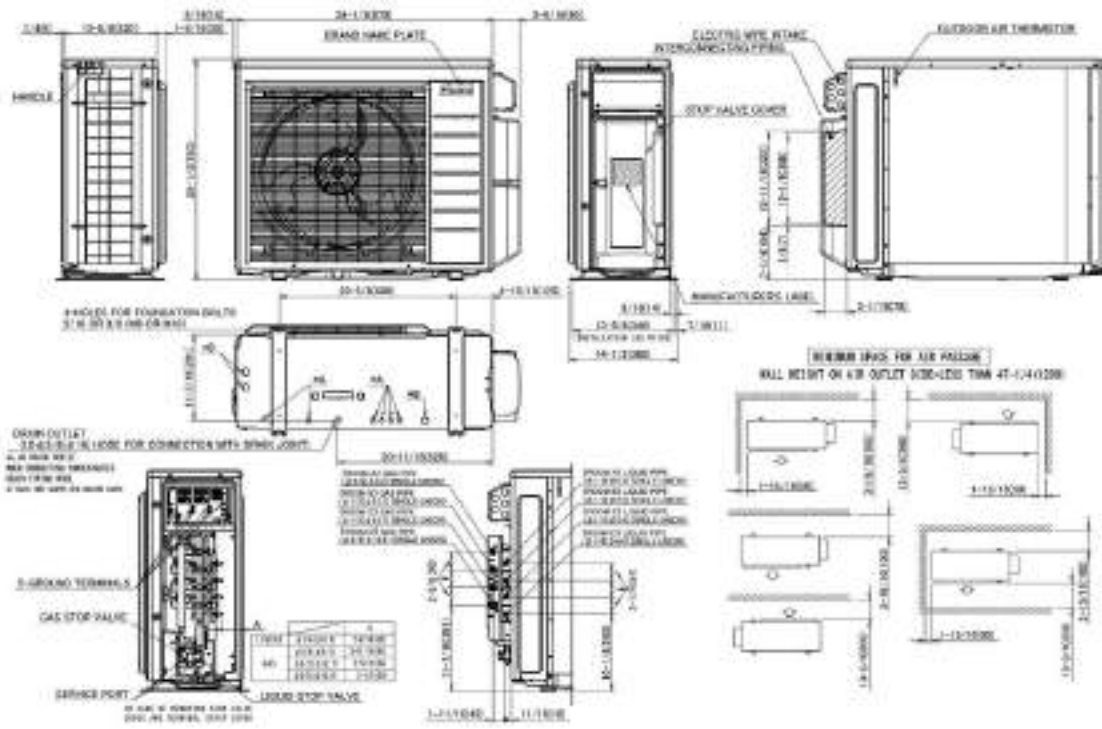

3D149809

5. Wiring Diagram

5.1 Indoor unit

CTXV07AVJU9, FTXV09/12AVJU9

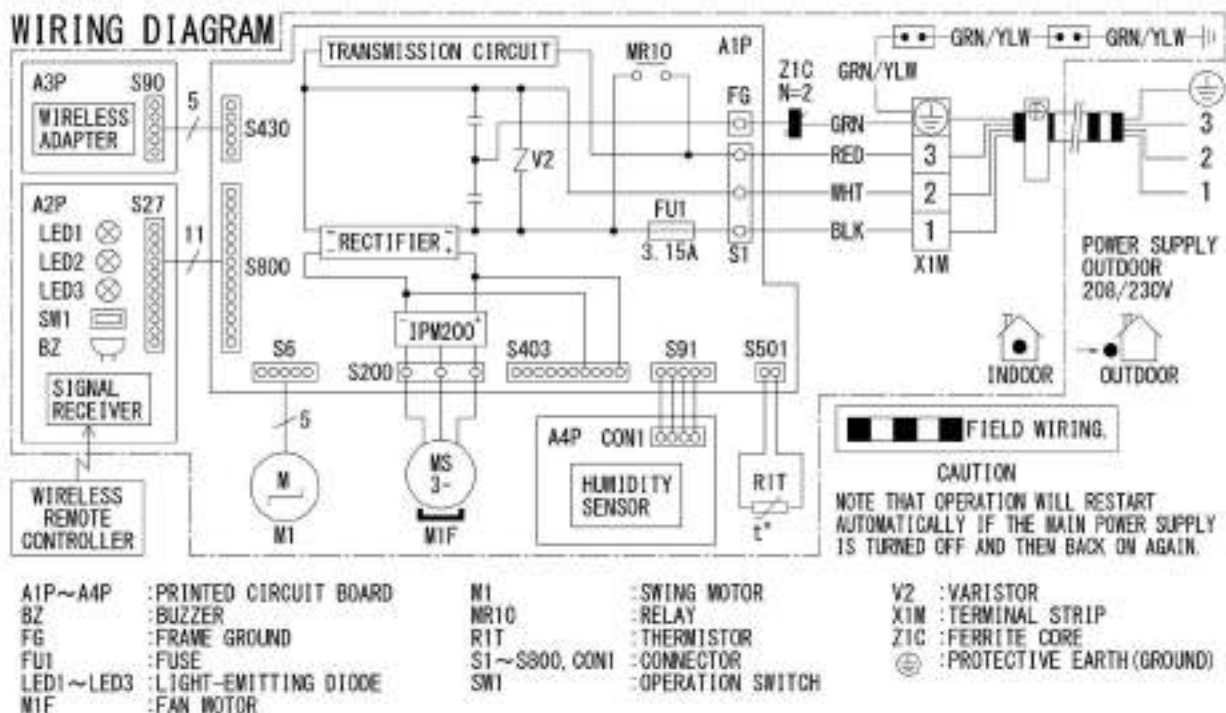

3D147521

FTXV15/18/24AVJU9

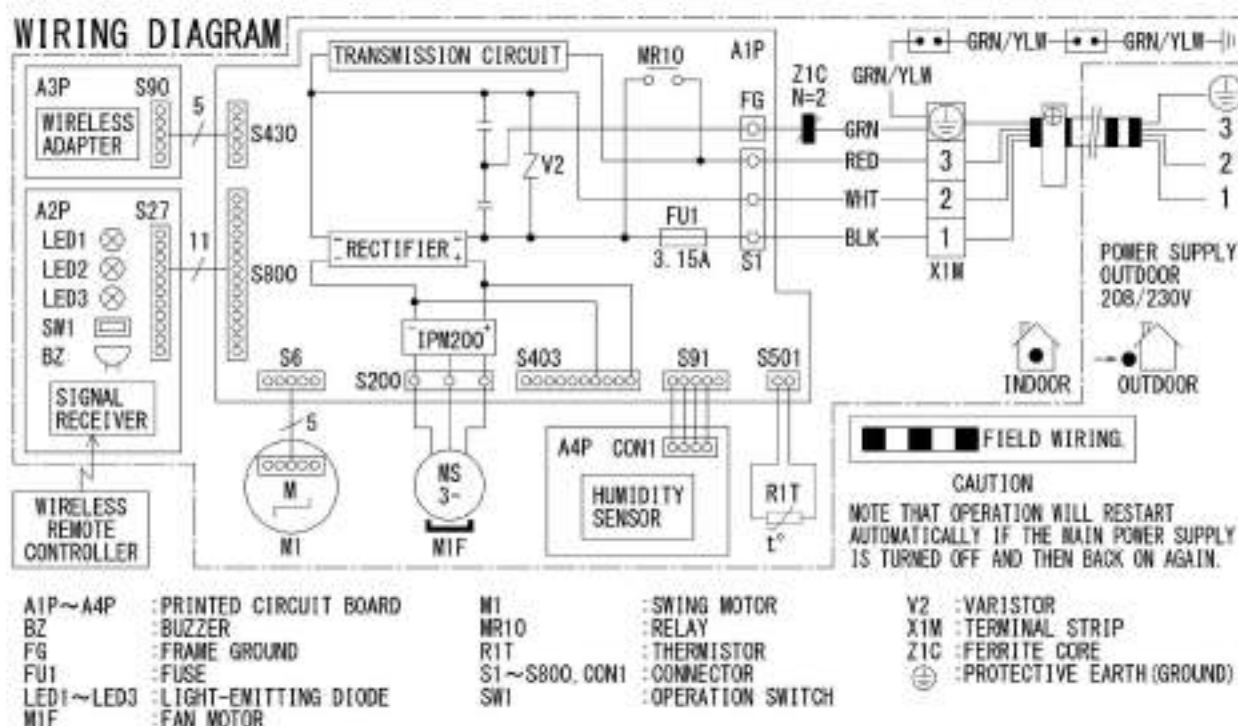

3D147460A

6. Piping Diagram

6.1 Indoor unit

CTXV07AVJU9, FTXV09/12AVJU9

FTXV15/18AVJU9

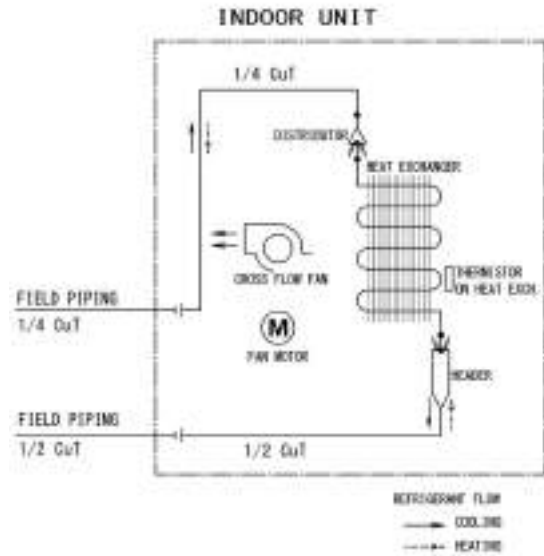
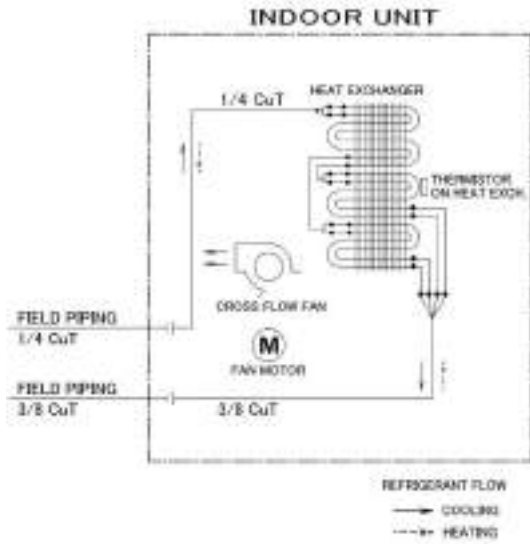

4D150950

4D091769E

FTXV24AVJU9

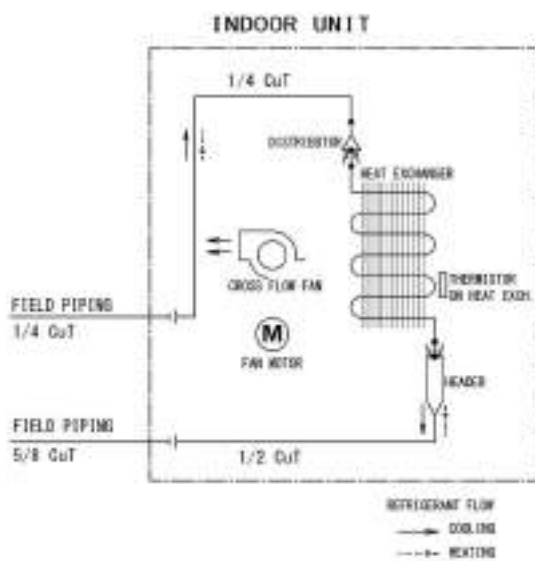

4D091768C

6.2 Outdoor unit 2MXM18AVJU9

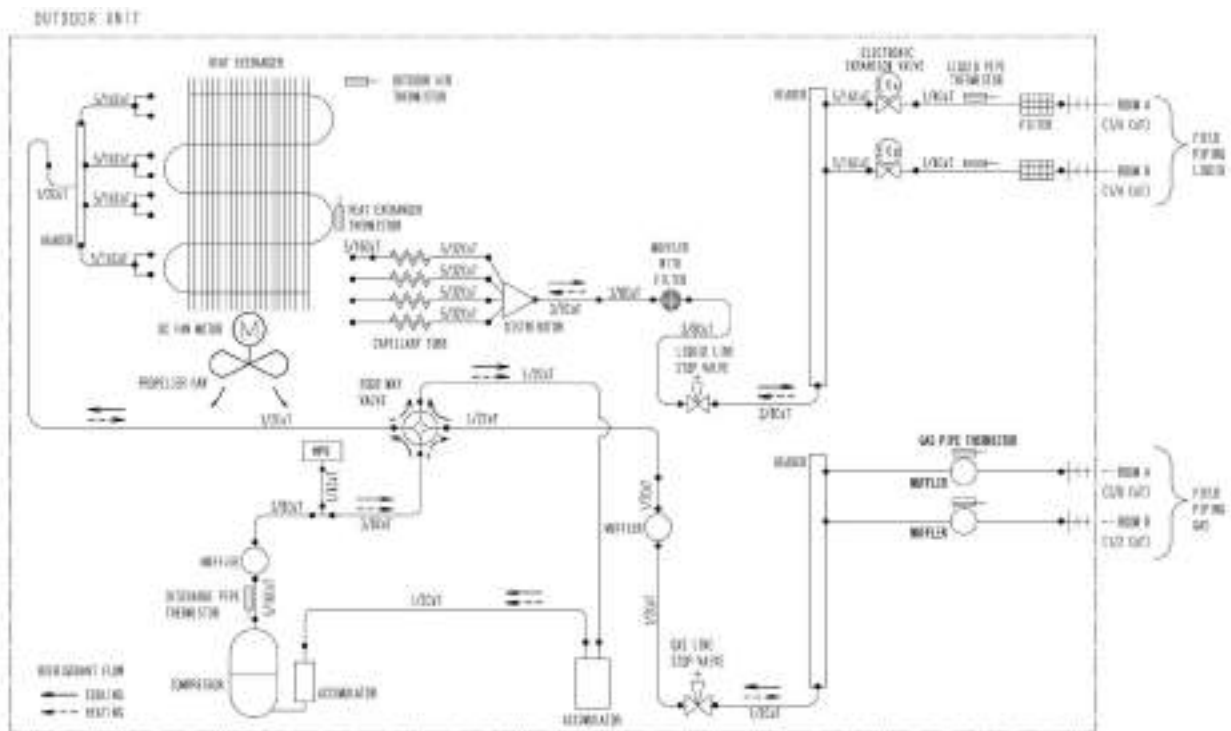

3D149796

3MXM24AVJU9

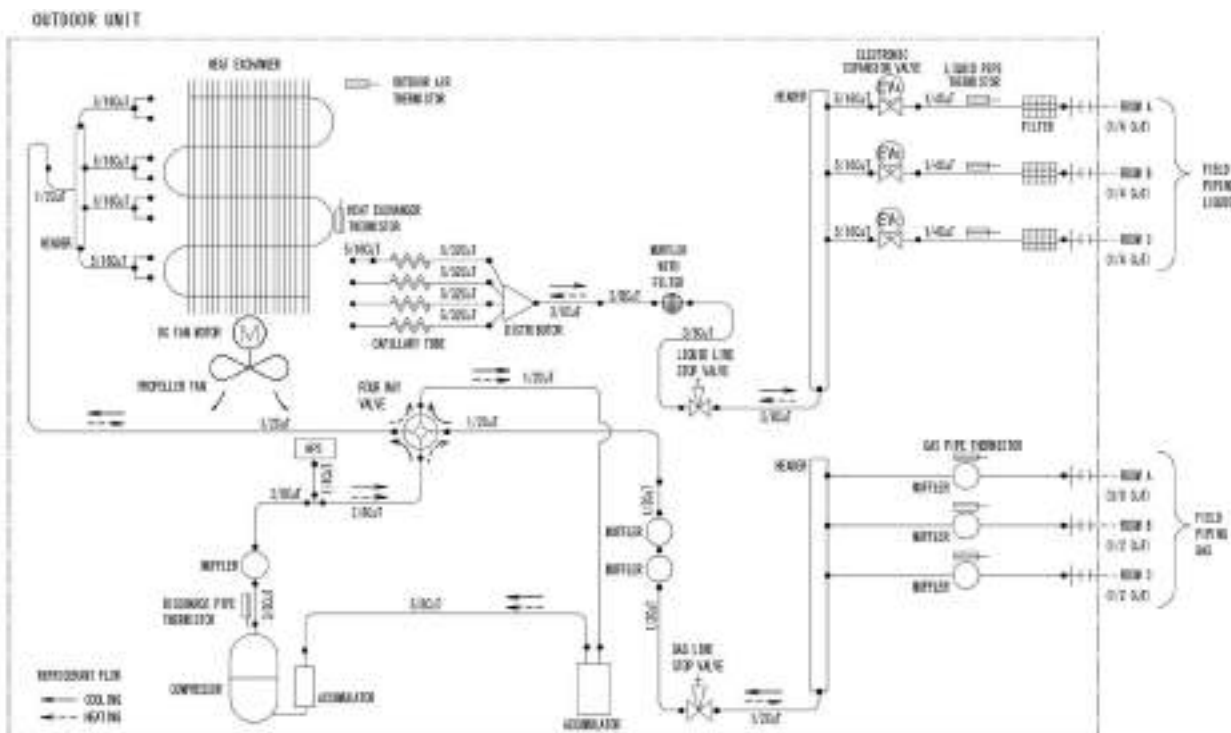

3D149798

4MXM36AVJU9

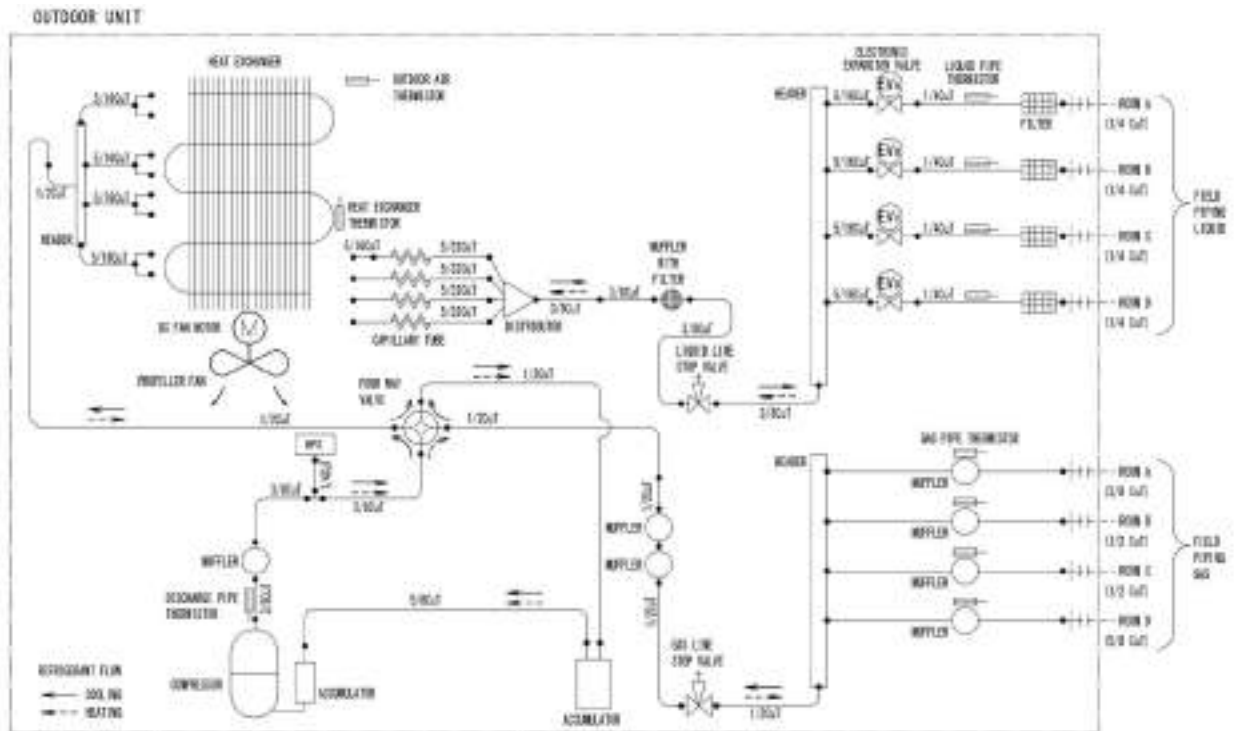

3D149799

2MXT18AVJU9, 2MXTH18AVJU9

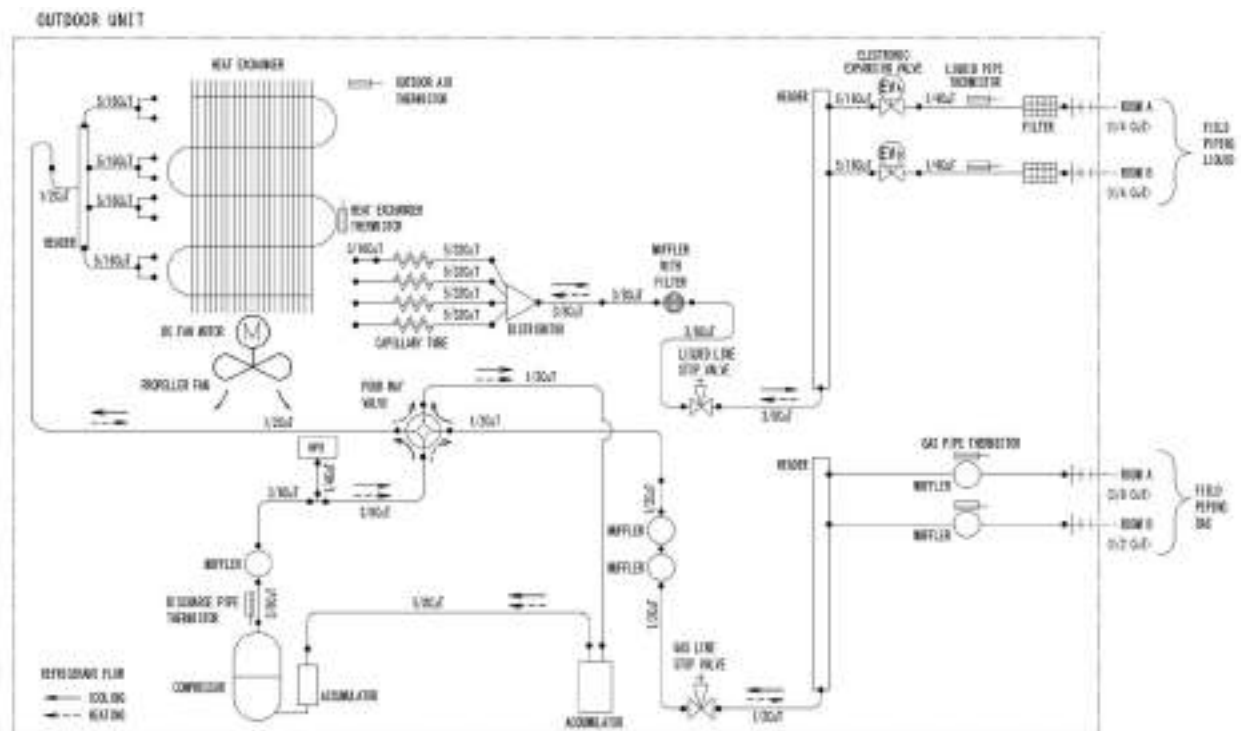

3D149797

7. Capacity Table

Refer to Engineering Data books below for the Combination Capacity.

| Type | Model Name | Reference |
|-------------------|---|------------|
| Standard type | 2MXM18AVJU9 3MXM24AVJU9 4MXM36AVJU9 | EDUS122403 |
| Cold climate type | 2MXT18AVJU9 2MXTH18AVJU9 | EDUS122404 |

8. Operation Limit

2MXM18AVJU9, 3MXM24AVJU9, 4MXM36AVJU9

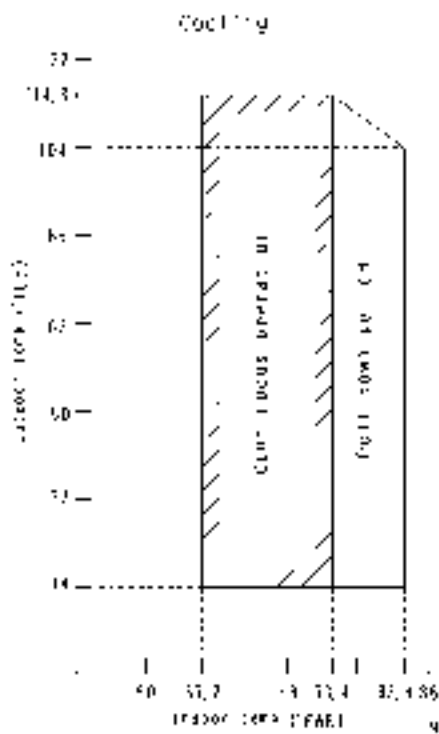

Notes:
 The graphs are based on the following conditions:
 • Evaporator piping length: 25m
 • Condenser pressure: 0.47 MPa
 • Air flow rate: 10 g/s

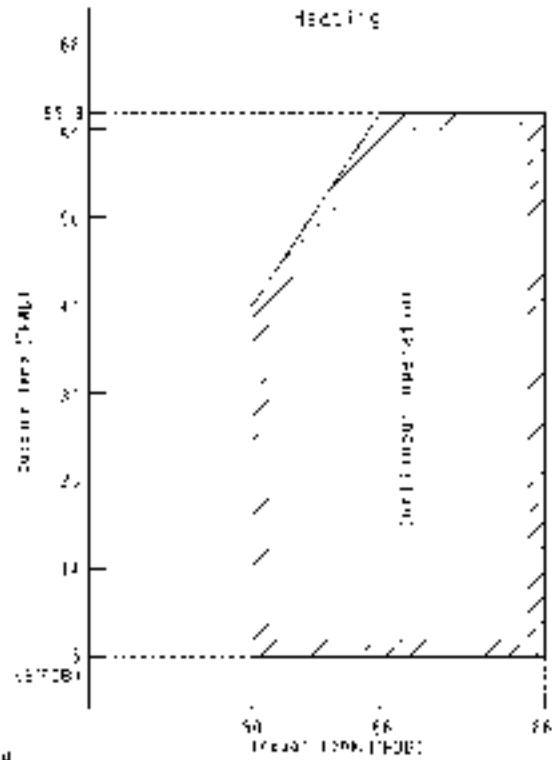

3D048149D

2MXT18AVJU9, 2MXTH18AVJU9

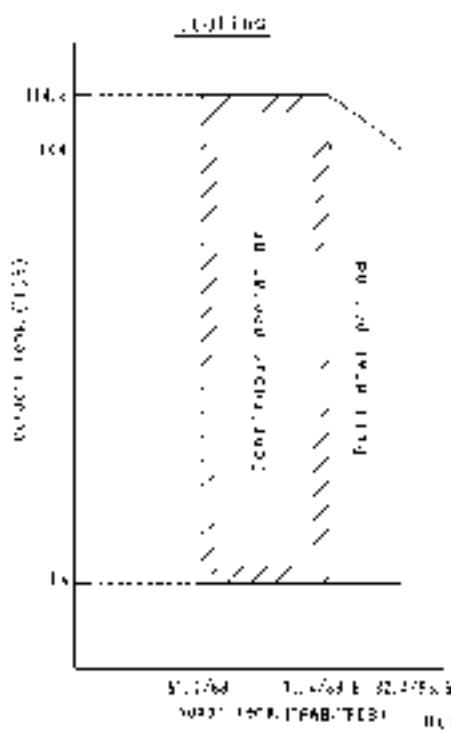

Notes:
 The graphs are based on the following conditions:
 • Evaporator piping length: 25m
 • Condenser pressure: 0.47 MPa
 • Air flow rate: 10 g/s

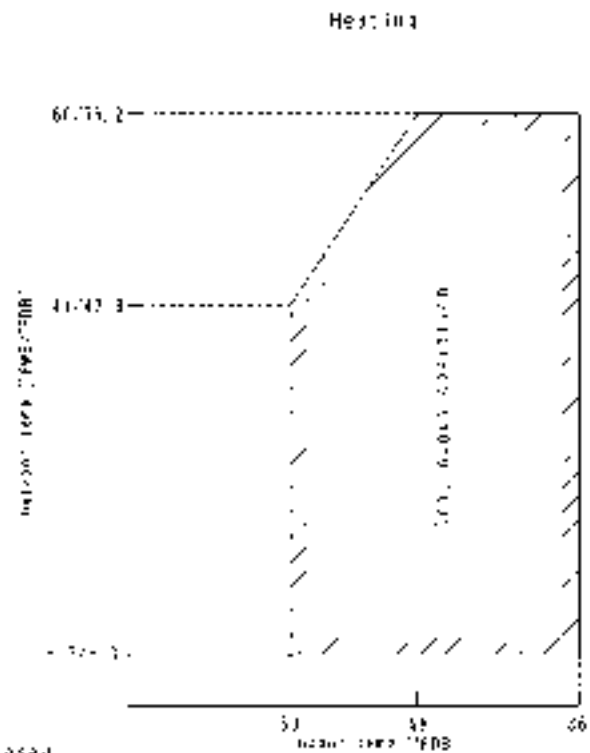

3D101428B

9. Sound Level

9.1 Measuring Location

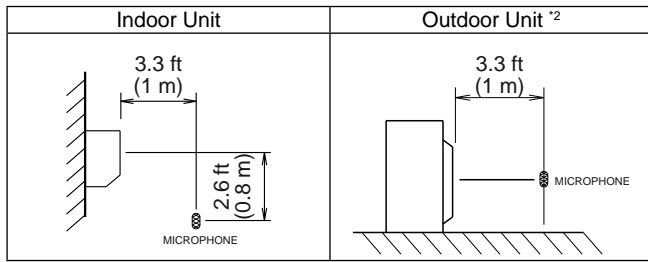

- Notes:**
1. Operation sound is measured in an anechoic chamber.
 2. The operation sound measuring method is based on JIS standard.
 3. The data are based on the conditions shown in the table below.

| Cooling | Heating |
|---|---|
| Indoor ; 80°FDB (26.7°CDB) / 67°FWB (19.4°CWB) Outdoor ; 95°FDB (35°CDB) / 75°FWB (23.9°CWB) | Indoor ; 70°FDB (21.1°CDB) / 60°FWB (15.6°CWB) Outdoor ; 47°FDB (8.3°CDB) / 43°FWB (6.1°CWB) |

9.2 Indoor unit CTXV07AVJU9

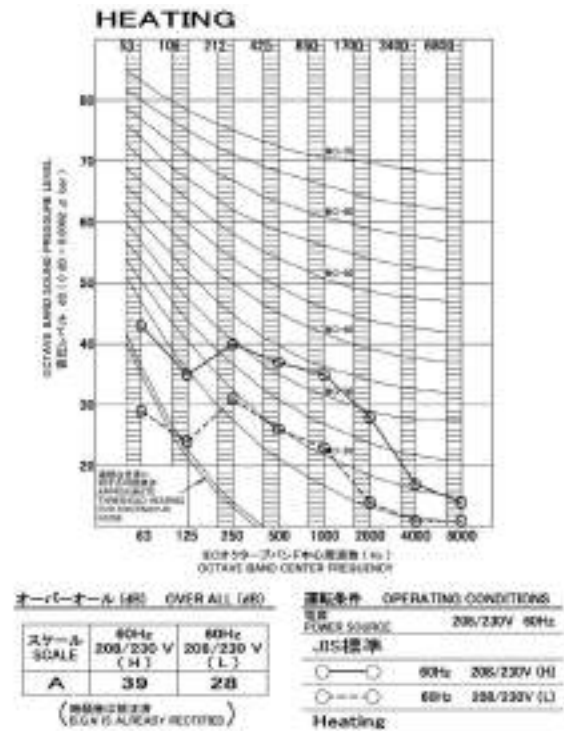
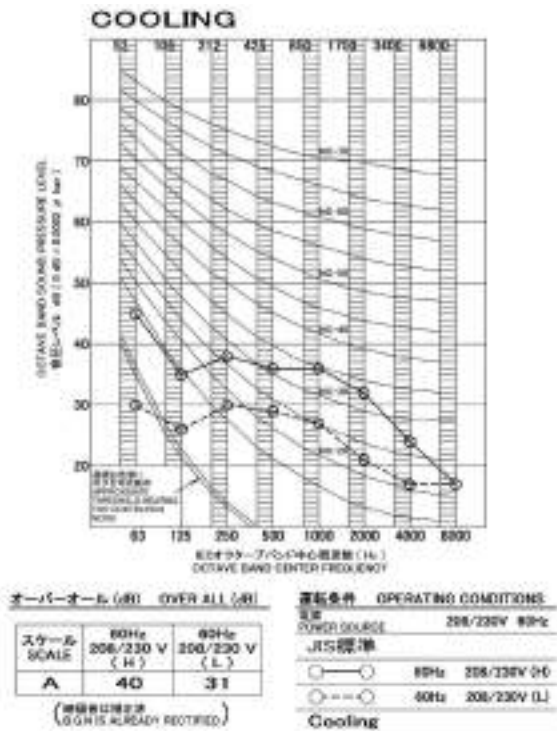

3D153119

FTXV09AVJU9

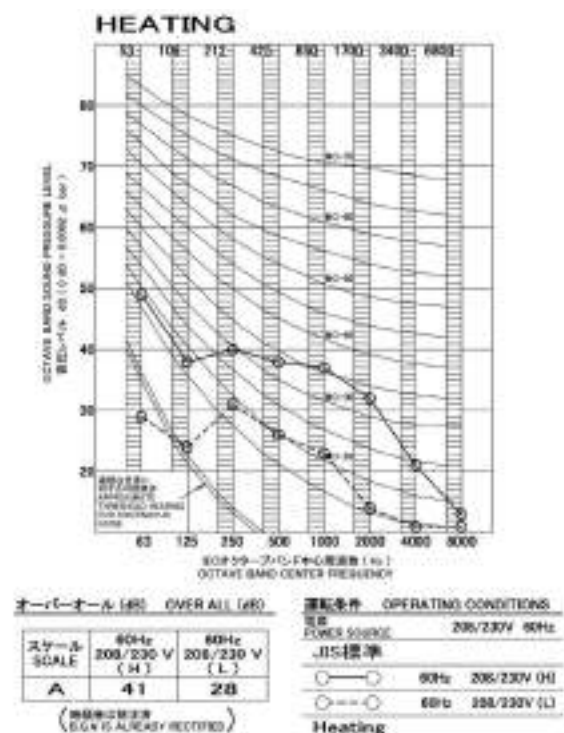
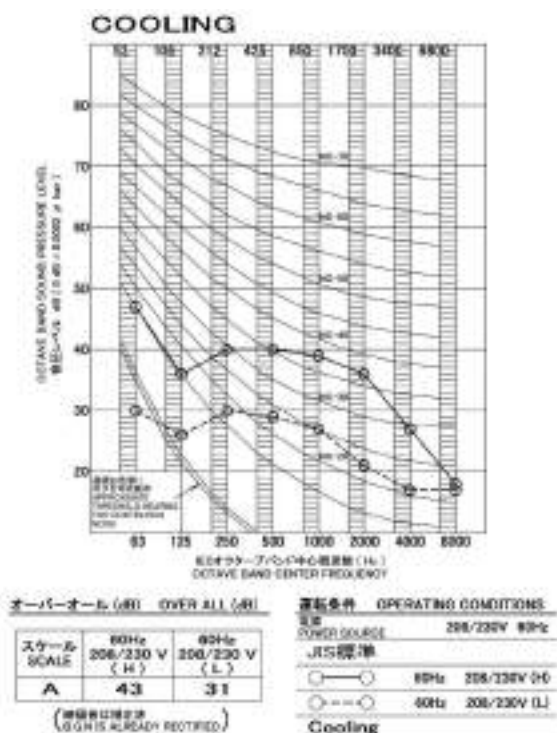

3D153120

FTXV12AVJU9

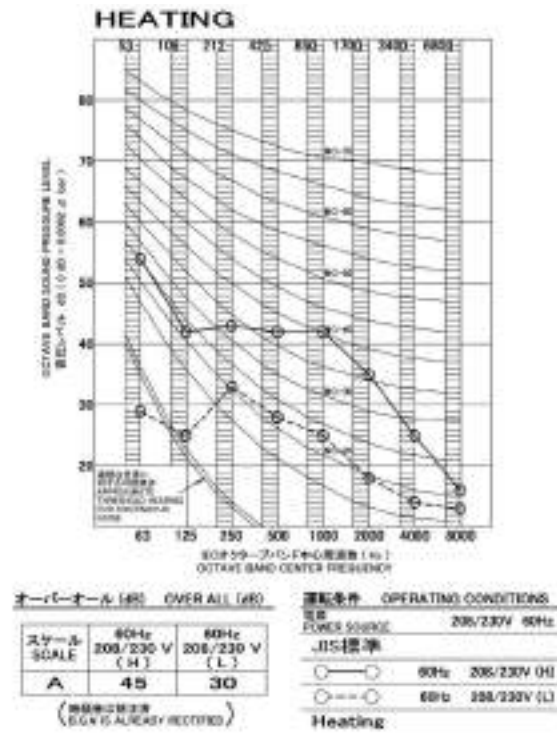
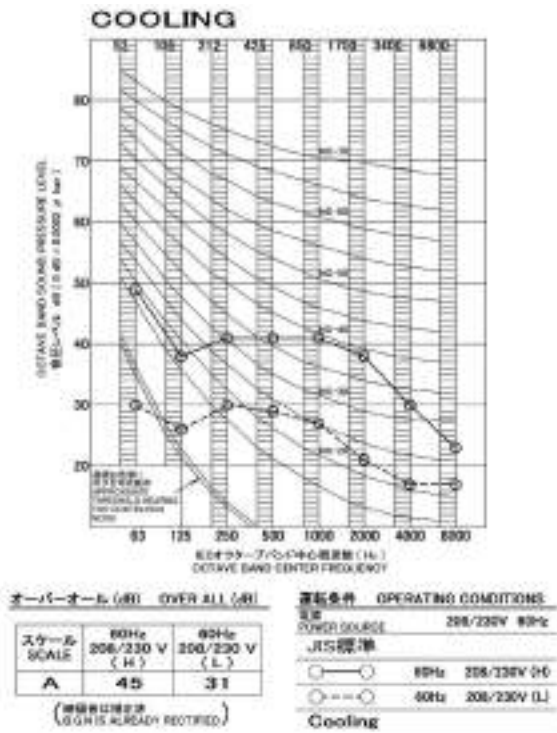

3D153121

FTXV15AVJU9

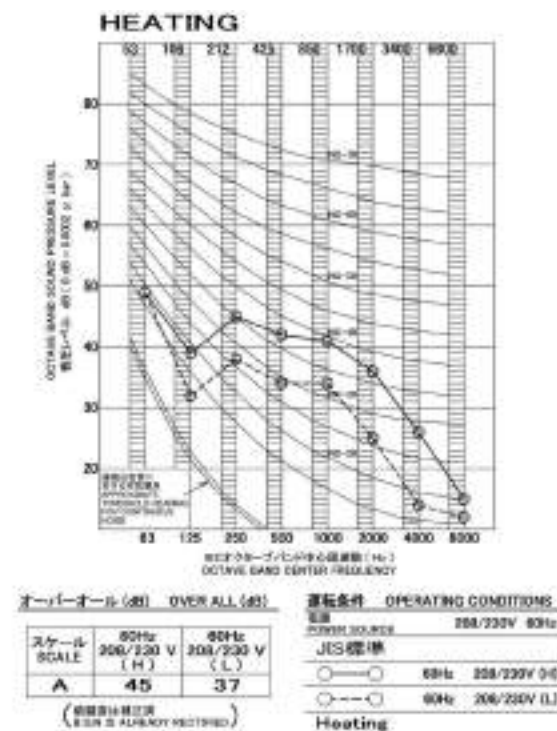
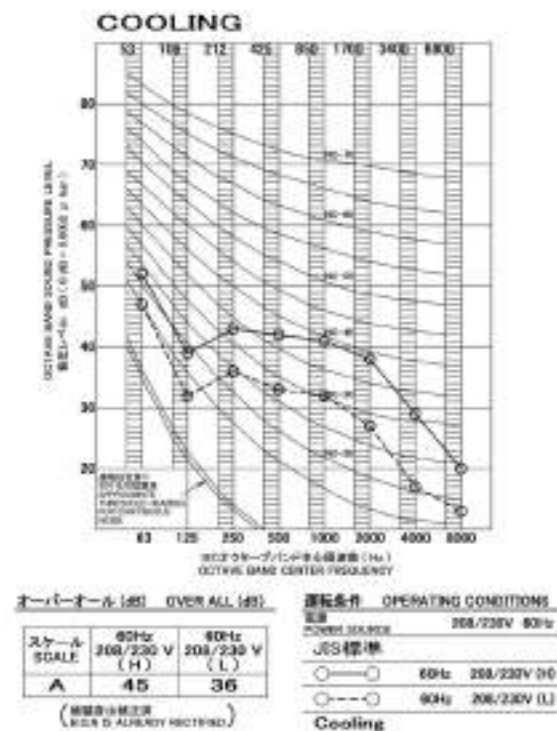

3D151900

FTXV18AVJU9

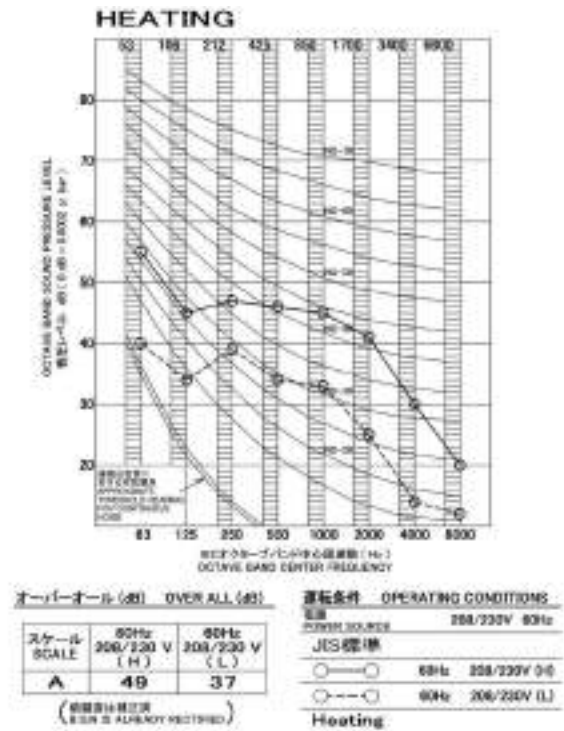
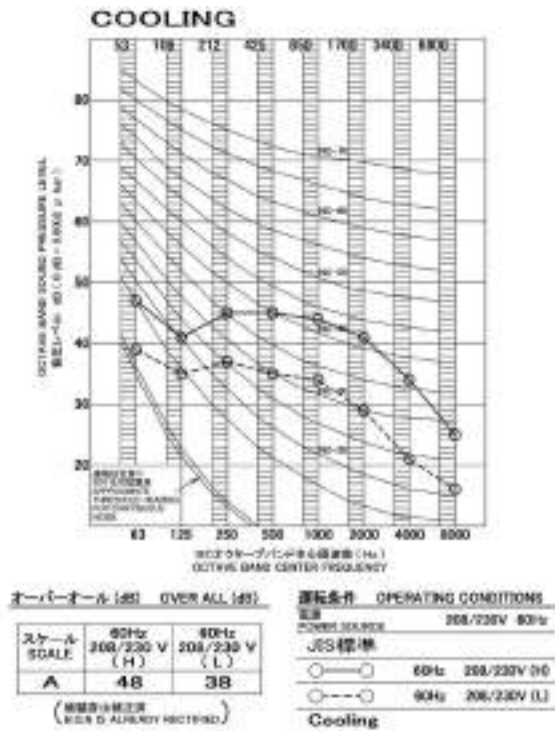

3D151901

FTXV24AVJU9

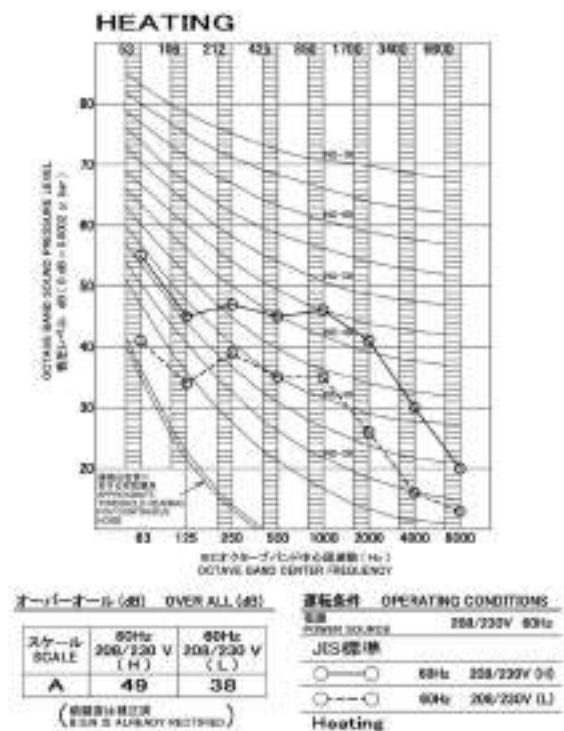
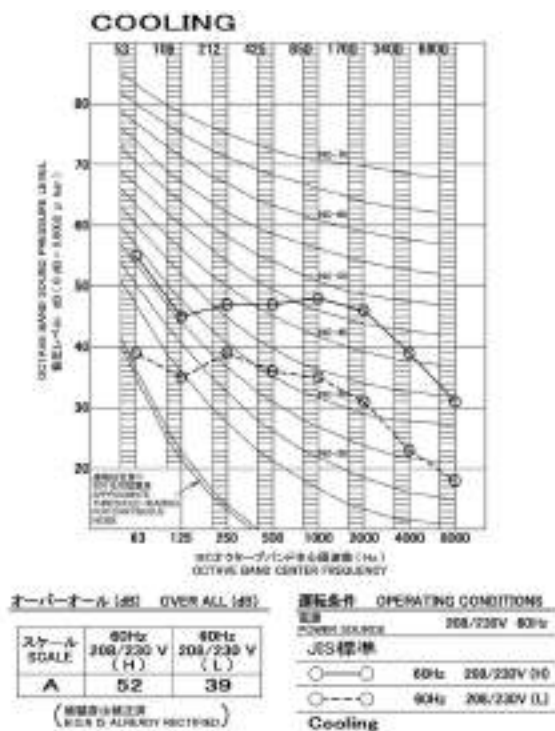

3D151902

9.3 Outdoor unit 2MXM18AVJU9

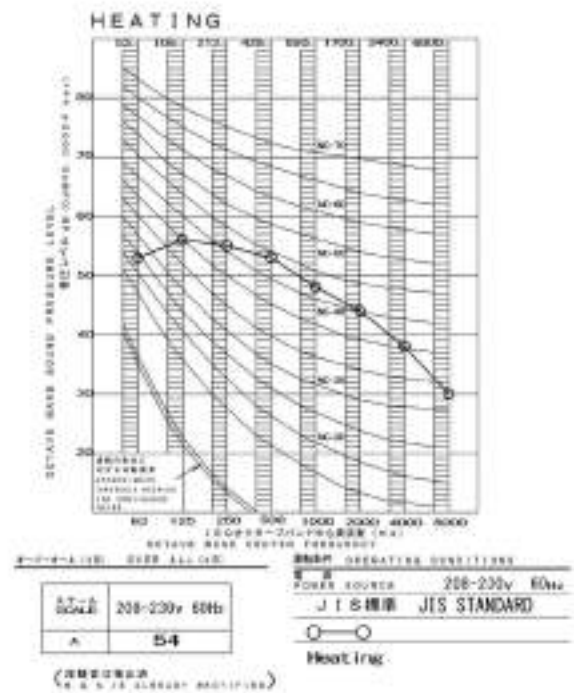
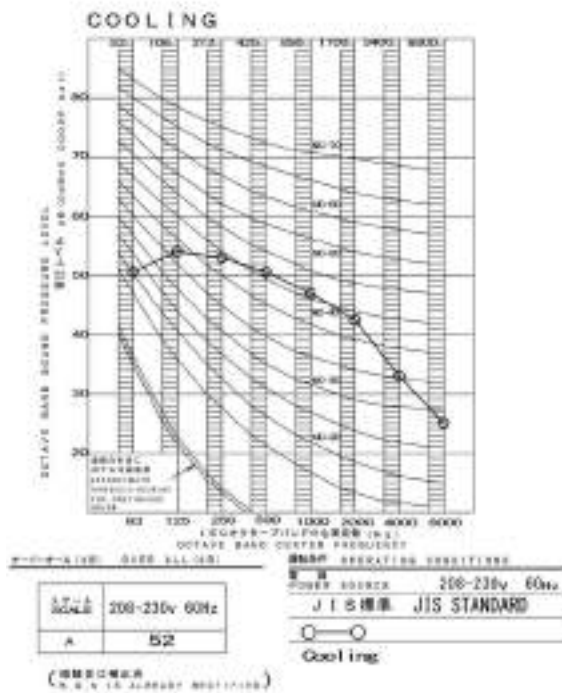

3D151393

3MXM24AVJU9, 2MXT18AVJU9, 2MXTH18AVJU9

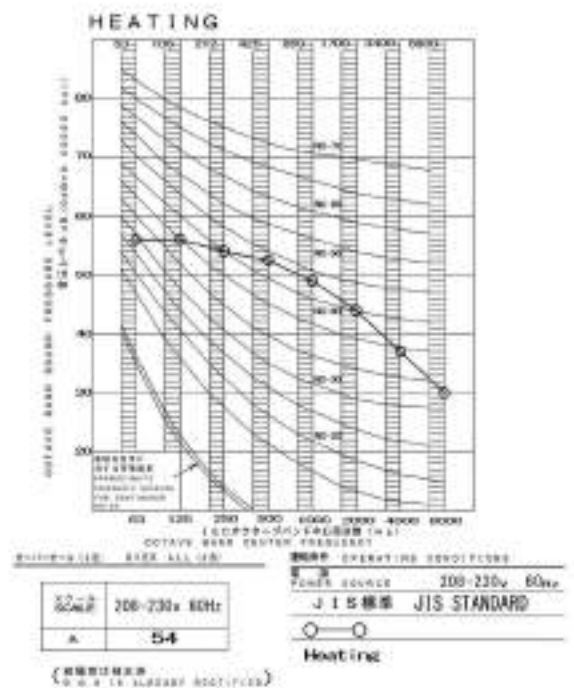
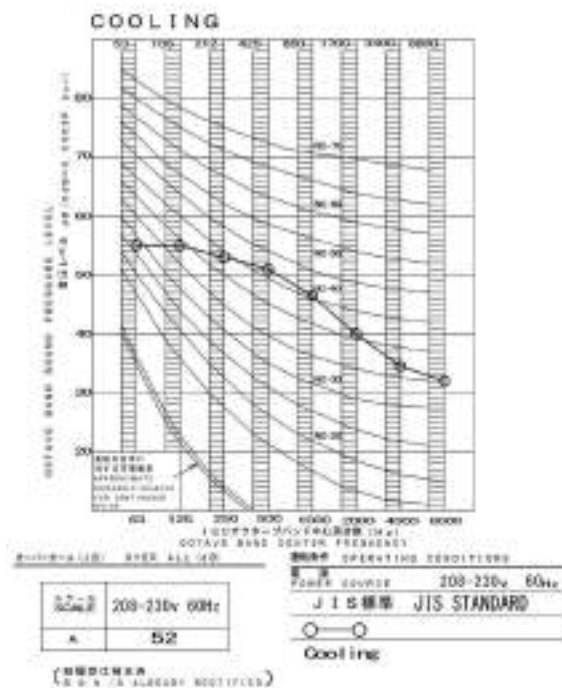

3D151394

4MXM36AVJU9

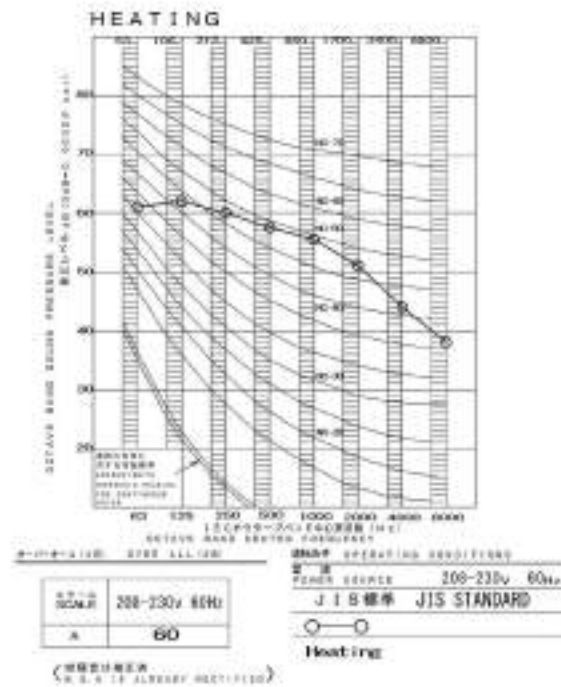
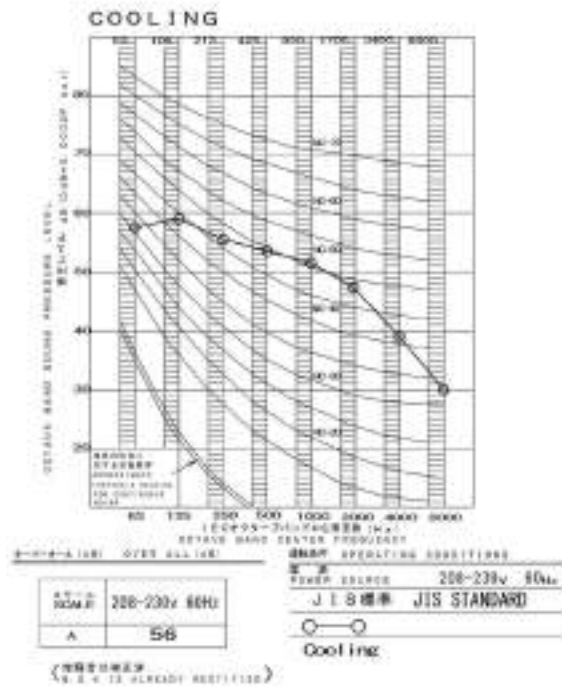

3D151395

10. Electric Characteristics

| Model | | Power Supply | | | | Fan/compressor |
|-------------|--------------|--------------------------------|--|------|------|----------------------|
| | | Hz - Volts | Voltage Range | MCA | MOP | Inverter drive input |
| MXM Series | 2MXM18AVJU9 | 60 Hz - 208 V 60 Hz - 230 V | Max. 60 Hz, 253 V Min. 60 Hz, 187 V | 15.6 | 20.0 | 13.7 |
| | 3MXM24AVJU9 | 60 Hz - 208 V 60 Hz - 230 V | Max. 60 Hz, 253 V Min. 60 Hz, 187 V | 19.9 | 25.0 | 17.4 |
| | 4MXM36AVJU9 | 60 Hz - 208 V 60 Hz - 230 V | Max. 60 Hz, 253 V Min. 60 Hz, 187 V | 24.1 | 25.0 | 20.8 |
| MXT Series | 2MXT18AVJU9 | 60 Hz - 208 V 60 Hz - 230 V | Max. 60 Hz, 253 V Min. 60 Hz, 187 V | 18.7 | 20.0 | 14.2 |
| MXTH Series | 2MXTH18AVJU9 | 60 Hz - 208 V 60 Hz - 230 V | Max. 60 Hz, 253 V Min. 60 Hz, 187 V | 19.6 | 20.0 | 14.2 |

C: 3D151489

Symbols:

MCA : Min. circuit ampacity (A)
 MOP : Max. overcurrent protective device (A)

Notes:

1. Inverter drive input is the current value specified in Annex 101.DVA.
2. Maximum allowable voltage variation between phases is 2%.
3. Select wire size based on the larger value of MCA.
4. Instead of fuse, use circuit breaker.
5. Be sure to install a ground leak detector.
 (This unit uses an inverter, which means that an earth leak detector capable of handling high harmonics must be used in order to prevent malfunctioning of the ground leak detector.)

Part 2 Installation Manual

| | |
|--------------------------------|----|
| 1. Indoor Unit | 34 |
| 1.1 CTXV07, FTXV09/12 | 34 |
| 1.2 FTXV15/18/24..... | 48 |
| 2. Outdoor Unit | 62 |
| 2.1 2/3/4MXM, 2MXT, 2MXTH..... | 62 |

1. Indoor Unit

1.1 CTXV07, FTXV09/12



Contents

| | | | |
|---|----------|--|-----------|
| Safety Considerations | 1 | Refrigerant Piping Work | 10 |
| Accessories | 3 | 1. Flaring the pipe end..... | 10 |
| Choosing an Installation Site | 3 | 2. Refrigerant piping | 10 |
| 1. Indoor unit | 3 | Installation Tips | 12 |
| 2. Wireless remote controller..... | 3 | 1. Removing and installing the front panel | 12 |
| Indoor Unit Installation Diagram | 4 | 2. Removing and installing the front grille..... | 12 |
| Indoor Unit Installation | 5 | 3. How to set the different addresses | 13 |
| 1. Installing the mounting plate..... | 5 | 4. Pump down operation..... | 13 |
| 2. Drilling a wall hole and installing wall embedded pipe ... | 5 | Trial Operation and Testing | 14 |
| 3. Installing the indoor unit | 6 | 1. Trial operation and testing | 14 |
| 4. Wiring | 8 | 2. Test items | 14 |
| 5. Drain piping | 9 | | |





The pictures in this document are for illustrative purposes only.

Safety Considerations

Refer also to the General Safety Considerations in the separate booklet.

| | |
|---|---|
|  | Read the precautions in this manual carefully before operating the unit. |
|  | This appliance is filled with R32. |

Read these **Safety Considerations for Installation** carefully before installing an air conditioner or heat pump. After completing the installation, make sure that the unit operates properly during the startup operation. Instruct the user on how to operate and maintain the unit. Inform users that they should store this installation manual with the operation manual for future reference. Always use a licensed installer or contractor to install this product. Improper installation can result in water or refrigerant leakage, electric shock, fire, or explosion. Meanings of **DANGER**, **WARNING**, **CAUTION**, and **NOTE** Symbols:

-  **DANGER** Indicates an imminently hazardous situation which, if not avoided, will result in death or serious injury.
-  **WARNING** Indicates a potentially hazardous situation which, if not avoided, could result in death or serious injury.
-  **CAUTION** Indicates a potentially hazardous situation which, if not avoided, may result in minor or moderate injury. It may also be used to alert against unsafe practices.
-  **NOTE** Indicates situations that may result in equipment or property-damage accidents only.

DANGER

- Refrigerant gas is heavier than air and replaces oxygen. A massive leak can lead to oxygen depletion, especially in basements, and an asphyxiation hazard could occur leading to serious injury or death.
- Do not ground units to water pipes, gas pipes, telephone wires, or lightning rods as incomplete grounding can cause a severe shock hazard resulting in severe injury or death. Additionally, grounding to gas pipes could cause a gas leak and potential explosion causing severe injury or death.

- If refrigerant gas leaks during installation, ventilate the area immediately. Refrigerant gas may produce toxic gas if it comes into contact with fire. Exposure to this gas could cause severe injury or death.
- After completing the installation work, check that the refrigerant gas does not leak throughout the system.
- Do not install unit in an area where flammable materials are present due to risk of explosions that can cause serious injury or death.
- Safely dispose all packing and transportation materials in accordance with federal/state/local laws or ordinances. Packing materials such as nails and other metal or wood parts, including plastic packing materials used for transportation may cause injury or death by suffocation.
- All possible ignition sources, including cigarette smoking, should be kept sufficiently far away from the site of installation, repairing, removing and disposal.

WARNING

- Only qualified personnel licensed or certified in their jurisdiction must carry out the installation work. Installation must be done in accordance with this installation manual. Improper installation may result in water leakage, electric shock, or fire.
- Pipe-work including piping material, pipe routing, and installation shall include protection from physical damage in operation and service, and be in compliance with national and local codes and standards, such as ASHRAE 15, ASHRAE 15.2, IAPMO Uniform Mechanical Code, ICC International Mechanical Code, or CSA B52. All field joints shall be accessible for inspection prior to being covered or enclosed.
- When installing the unit in a small room, take measures to keep the refrigerant concentration from exceeding allowable safety limits. Excessive refrigerant leaks, in the event of an accident in a closed ambient space, can lead to oxygen deficiency.
- Use only specified accessories and parts for installation work. Failure to use specified parts may result in water leakage, electric shock, fire, or the unit falling.
- Install the air conditioner or heat pump on a foundation strong enough that it can withstand the weight of the unit. A foundation of insufficient strength may result in the unit falling and causing injury.

- Take into account strong winds, typhoons, or earthquakes when installing. Improper installation may result in the unit falling and causing accidents.
- Make sure that a separate power supply circuit is provided for this unit and that all electrical work is carried out by qualified personnel licensed or certified in their jurisdiction according to local, state, and national regulations. An insufficient power supply capacity or improper electrical construction may lead to electric shock or fire.
- Make sure that all wiring is secured, that specified wires are used, and that no external forces act on the terminal connections or wires. Improper connections or installation may result in fire.
- When wiring, position the wires so that the service lid can be securely fastened. Improper positioning of the service lid may result in electric shock, fire, or the terminals overheating.
- Before touching electrical parts, turn off the unit.
- The circuit must be protected with safety devices in accordance with local and national codes, i.e. a circuit breaker.
- Securely fasten the outdoor unit service lid. If the service lid is not installed properly, dust or water may enter the outdoor unit causing fire or electric shock.
- When installing or relocating the system, keep the refrigerant circuit free from substances other than the specified refrigerant (R32) such as air. Any presence of air or other foreign substance in the refrigerant circuit can cause an abnormal pressure rise or rupture, which may result in equipment damage and even injury.
- Do not change the setting of the protection devices. If the pressure switch, thermal switch, or other protection device is shorted and operated forcibly, or parts other than those specified by Daikin are used, fire or explosion may occur.
- Do not use means to accelerate the defrosting process (if possible) or to clean, other than those recommended by the manufacturer.
- The appliance must be stored in a room without continuously operating ignition sources (for example: open flames, an operating gas appliance or an operating electric heater).
- Do not pierce or burn.
- Be aware that refrigerants may not contain an odor.
- Comply with national gas regulations.
- The indoor equipment and pipes shall be securely mounted and guarded such that accidental rupture of equipment cannot occur from such events as moving furniture or reconstruction activities.

⚠ CAUTION

- Do not touch the switch with wet fingers. Touching a switch with wet fingers can cause electric shock.
- Do not allow children to play on or around the unit to prevent injury.
- Wear adequate personal protective equipment (protective gloves, safety glasses,...) when installing, maintaining or servicing the system.
- The heat exchanger fins are sharp enough to cut. To avoid injury, wear gloves or cover the fins while working around them.
- Do not touch the refrigerant pipes during and immediately after operation as the refrigerant pipes may be hot or cold, depending on the condition of the refrigerant flowing through the refrigerant piping, compressor, and other refrigerant cycle parts. Your hands may suffer burns or frostbite if you touch the refrigerant pipes. To avoid injury, give the pipes time to return to normal temperature or, if you must touch them, be sure to wear proper gloves.
- Install drain piping to ensure proper drainage. Improper drain piping may result in water leakage and property damage.
- Insulate piping to prevent condensation.







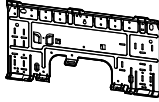

- Be careful when transporting the product.
- Do not turn off the power immediately after stopping operation. Always wait for at least 5 minutes before turning off the power. Otherwise, water leakage may occur.
- Do not use a charging cylinder. Using a charging cylinder may cause the refrigerant to deteriorate.
- Refrigerant R32 in the system must be kept clean, dry, and tight.
 - (a) Clean and Dry -- Foreign materials (including mineral oils such as SUNISO oil or moisture) should be prevented from getting into the system.
 - (b) Tight -- R32 does not contain any chlorine, does not destroy the ozone layer, and does not reduce the earth's protection against harmful ultraviolet radiation. R32 can contribute to the greenhouse effect if it is released. Therefore take proper measures to check for the tightness of the refrigerant piping installation. Read the chapter *Refrigerant Piping Work* and follow the procedures.
- The indoor unit is for R32. See the catalog for outdoor models that can be connected. Normal operation is not possible when connected to non-compatible outdoor units.
- Remote controller (wireless kit) transmitting distance can be shorter than expected in rooms with electronic fluorescent lamps (inverter or rapid start types). Install the indoor unit far away from fluorescent lamps as much as possible.
- Indoor units are for indoor installation only. Outdoor units can be installed either outdoors or indoors.
- Do not install the air conditioner or heat pump in the following locations:
 - (a) Where a mineral oil mist or oil spray or vapor is produced, for example, in a kitchen. Plastic parts may deteriorate and fall off or result in water leakage.
 - (b) Where corrosive gas, such as sulfurous acid gas, is produced. Corroding copper pipes or soldered parts may result in refrigerant leakage.
 - (c) Near machinery emitting electromagnetic waves. Electromagnetic waves may disturb the operation of the control system and cause the unit to malfunction.
 - (d) Where flammable gas may leak, where there is carbon fiber, or ignitable dust suspension in the air, or where volatile flammables such as thinner or gasoline are handled. Operating the unit in such conditions can cause a fire.
- Take adequate measures to prevent the outdoor unit from being used as a shelter by small animals. Small animals making contact with electrical parts can cause malfunctions, smoke, or fire. Instruct the user to keep the area around the unit clean.
- Servicing shall be performed only as recommended by the manufacturer and licensed or certified in their jurisdiction.

⚠ NOTE

- The indoor unit should be positioned where the unit and interunit wires (outdoor to indoor) are at least 3.3ft (1m) away from any televisions or radios. (The unit may cause interference with the picture or sound.) Depending on the radio waves, a distance of 3.3ft (1m) may not be sufficient to eliminate the noise.
- Dismantling the unit, treatment of the refrigerant, oil and additional parts must be done in accordance with the relevant local, state, and national regulations.
- Only use tools for R32, such as a gauge manifold, charge hose, gas leak detector, reverse flow check valve, refrigerant charge base, vacuum gauge, or refrigerant recovery equipment.
- If the conventional refrigerant and refrigerator oil are mixed in R32, the refrigerant may deteriorate.
- As maximum allowable pressure is 604psi (4.17MPa), the wall thickness of field-installed pipes should be selected in accordance with the relevant local, state, and national regulations.

FTN006(R32)-U

Accessories

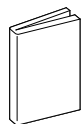
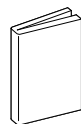
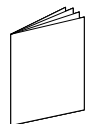
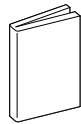
| | | | | | |
|---|----------|--|----------|--|----------|
| <p>(A) Mounting plate</p>  | <p>1</p> | <p>(B) Mounting plate fixing screw M4 × 1" (M4 × 25mm)</p>  | <p>7</p> | <p>(C) Titanium apatite deodorizing filter</p>  | <p>2</p> |
| <p>(D) Wireless remote controller</p>  | <p>1</p> | <p>(E) Remote controller holder</p>  | <p>1</p> | <p>(F) Remote controller holder fixing screw M3 × 13/16" (M3 × 20mm)</p>  | <p>2</p> |
| <p>(G) Dry battery AAA. LR03 (alkaline)</p>  | <p>2</p> | <p>(H) Indoor unit fixing screw M4 × 1/2" (M4 × 12mm)</p>  | <p>2</p> | <p>(J) Insulation tape</p>  | <p>1</p> |
| <p>(K) Operation manual</p>  | <p>1</p> | <p>(L) Installation manual</p>  | <p>1</p> | <p>(M) Warranty</p>  | <p>1</p> |
| <p>(N) General safety considerations</p>  | <p>1</p> | | | | |

Choosing an Installation Site

- Before choosing the installation site, obtain user approval.

1. Indoor unit

- The indoor unit should be positioned in a place where:
 - 1) the restrictions on the installation requirements specified in “Indoor Unit Installation Diagram” on page 4 are met,
 - 2) both the air inlet and air outlet are unobstructed,
 - 3) the unit is not exposed to direct sunlight,
 - 4) drainage occurs easily,
 - 5) the unit is away from sources of heat or steam,
 - 6) there is no source of machine oil vapor (this may shorten the indoor unit service life),
 - 7) cool/warm air is circulated throughout the room,
 - 8) the unit is away from electronic ignition type fluorescent lamps (inverter or rapid start type) as they may affect the remote controller range,
 - 9) the unit is at least 3.3ft (1m) away from any television or radio set (the unit may cause interference with the picture or sound),
 - 10) no laundry equipment is nearby,
 - 11) the signal strength of the router is stable (insufficient signal strength can prevent stable communication).

2. Wireless remote controller

- Turn on all the fluorescent lamps in the room, if any, and find a location where the remote controller signals are properly received by the indoor unit (within 23ft (7m)).

Indoor Unit Installation Diagram

The (A) mounting plate should be installed on a wall which can support the weight of the indoor unit.

■ **How to attach the indoor unit**
Hook the hooks of the bottom frame to the (A) mounting plate. If the hooks are difficult to hook, remove the front grille.

■ **How to remove the indoor unit**
Push up the marked area (at the lower part of the front grille) to release the hooks. If it is difficult to release, remove the front grille.

(A) Mounting plate

(B) Mounting plate fixing screw
M4 × 1" (M4 × 25mm)

Front grille

Bottom frame

Hook

Mark (rear side)

1-3/16" (30mm) or more from ceiling

1-15/16" (50mm) or more from walls (on both sides)

Screws M4 × 5/8" (M4 × 16mm)

Front panel

Air filters

Caulk pipe hole gap with putty.

Do not connect commercially available drain hose directly to the indoor unit. (Water leakage may result)

Wrap with the finishing tape so that no gap is left.

Cut thermal insulation pipe to an appropriate length and wrap it with tape, making sure that no gap is left in the insulation pipe's cut line.

Wrap the insulation pipe with the finishing tape from bottom to top.

Service lid
The service lid is removable.

■ **Opening method**

- 1) Remove the service lid screw.
- 2) Pull out the service lid horizontally in the direction of the arrow.
- 3) Pull down.

(C) Titanium apatite deodorizing filter

Titanium apatite deodorizing filter

• The titanium apatite deodorizing filter can be attached in any orientation.

Before screwing the (E) remote controller holder to the wall, make sure that control signals are properly received by indoor unit.

(D) Wireless remote controller

(E) Remote controller holder

(E) Remote controller holder fixing screw
M3 × 13/16" (M3 × 20mm)

Indoor Unit Installation

1. Installing the mounting plate

- The mounting plate should be installed on a wall which can support the weight of the indoor unit.
 - Temporarily secure the mounting plate to the wall, make sure that the panel is completely level, and mark the drilling points on the wall.
 - Secure the mounting plate to the wall with screws.

Recommended mounting plate retention spots and dimensions

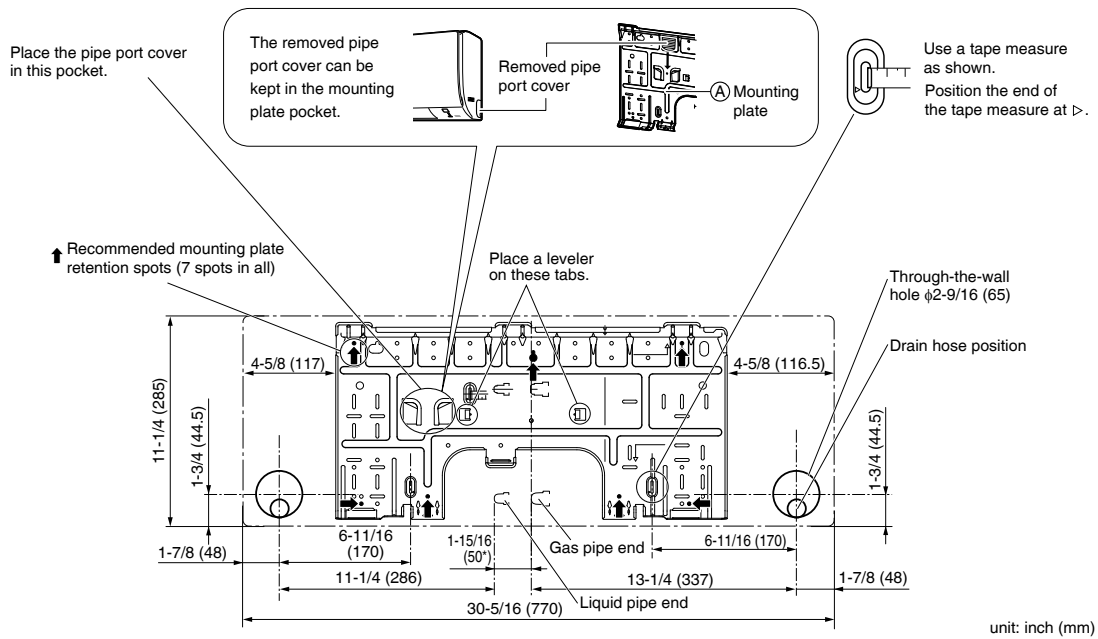

* Depending on the model, the actual distance between the liquid pipe end and gas pipe end may differ from the distance between those symbols on the mounting plate (the distance listed in this manual). Always measure the actual distance between the liquid pipe end and gas pipe end before installing refrigerant pipes.

2. Drilling a wall hole and installing wall embedded pipe

⚠ WARNING

For metal frame or metal board walls, be sure to use a wall embedded pipe and wall hole cover in the feed-through hole to prevent possible heat, electric shock, or fire.

- Be sure to caulk the gaps around the pipes with caulking material to prevent condensation.
 - Drill a feed-through hole with a $\phi 2-9/16$ inch (65mm) diameter through the wall at a downward angle toward the outside.
 - Insert a wall embedded pipe into the hole.
 - Insert a wall hole cover into wall pipe.
 - After completing refrigerant piping, wiring, and drain piping, caulk the pipe hole gap with putty.

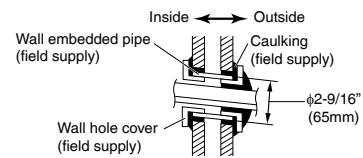

Even if a wall hole cover is not used, caulk both the outdoor and indoor sides with putty.

3. Installing the indoor unit

In the case of bending or curing refrigerant pipes, keep the following precautions in mind.
Abnormal sound may be generated if improper work is conducted.

- Do not strongly press the refrigerant pipes onto the bottom frame.
- Do not strongly press the refrigerant pipes on the front grille, either.

3-1. Right-side, right-back, or right-bottom piping

- 1) Attach the drain hose to the underside of the refrigerant pipes with adhesive vinyl tape.
- 2) Wrap the refrigerant pipes and drain hose together with ① insulation tape.

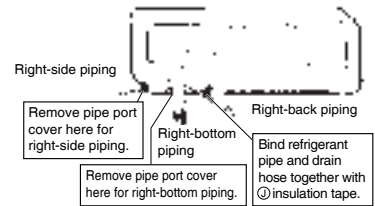

- 3) Pass the drain hose and refrigerant pipes through the wall hole, then position the indoor unit on the (A) mounting plate hooks by using the △ markings at the top of the indoor unit as a guide.

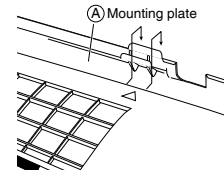

- 4) Open the front panel (Refer to "Installation Tips" on page 12), then open the service lid (Refer to "Indoor Unit Installation Diagram" on page 4).
- 5) Pass the inter-unit wire from the outdoor unit through the feed-through wall hole and pass to the front of indoor unit from the back. Then pull them at front side. Bend the ends of cable tie wires upward for easier work in advance. (If the interunit wire ends are to be stripped first, bundle wire ends with adhesive tape.)
- 6) Press the bottom frame of the indoor unit with both hands until it is firmly caught by the (A) mounting plate hooks. Make sure the wire leads do not catch on the edge of the indoor unit.

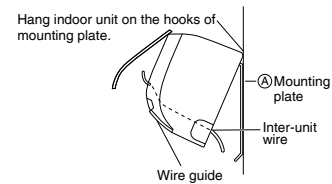

3-2. Left-side, left-back, or left-bottom piping

- 1) Switch around the drain plug and drain hose.

How to switch around the drain plug and drain hose

- 1) Remove the fixing screw and pull out the drain hose.
 - ① Remove fixing screw.
 - ② Pull out drain hose.
- 3) Switch around the drain hose and drain plug.
 - Push the drain plug all the way in using a hexagonal wrench (3/16 inch (4mm)).
 - Do not apply lubricating oil (refrigerant oil) to the drain plug when inserting it. The application of lubrication oil to the drain plug will deteriorate the plug to cause drain leakage from the plug.
 - Insert a hexagonal wrench (3/16 inch (4mm)).
 - No gap
- Insert drain hose securely and fix in place with fixing screw.

Indoor Unit Installation

- 2) Attach the drain hose to the underside of the refrigerant pipes with adhesive vinyl tape.

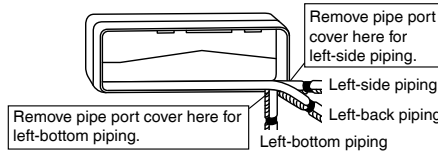

- 3) Shape the refrigerant pipes along the pipe path marking on the (A) mounting plate.
- 4) Pass the drain hose and refrigerant pipes through the wall hole, then position the indoor unit on the (A) mounting plate hooks, using the Δ markings at the top of the indoor unit as a guide.

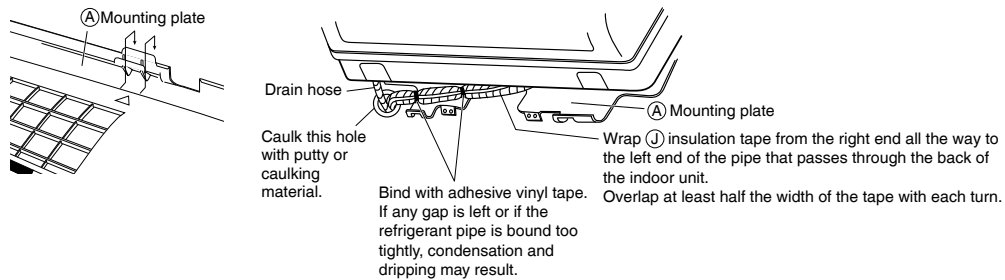

- 5) Open the front panel (Refer to "Installation Tips" on page 12), then open the service lid (Refer to "Indoor Unit Installation Diagram" on page 4).
- 6) Pass the inter-unit wire from the outdoor unit through the feed-through wall hole and pass to the front of indoor unit from the back. Then pull them at front side. Bend the ends of cable tie wires upward for easier work in advance. (If the interunit wire ends are to be stripped first, bundle wire ends with adhesive tape.)
- 7) Connect the refrigerant pipes.
- 8) In case of pulling the drain hose through the back of the indoor unit, wrap the refrigerant pipes and drain hose together with (D) insulation tape as shown in the figure below.
- 9) Press the bottom frame of the indoor unit with both hands until it is firmly caught by the (A) mounting plate hooks. Make sure that the wires do not catch on the edge of the indoor unit.

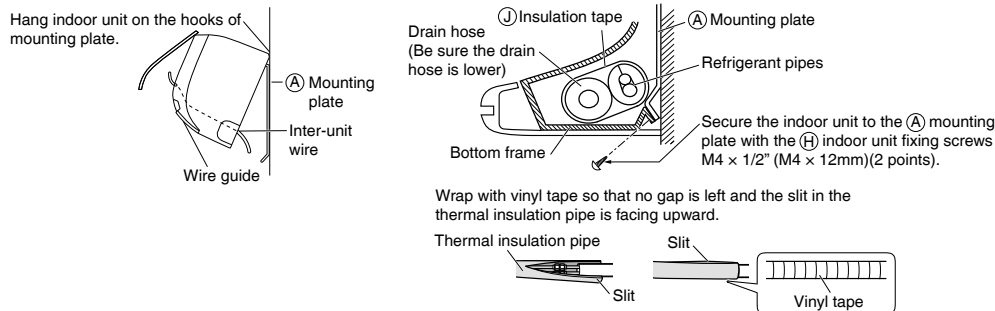

3-3. Wall embedded piping

Follow the instructions given under left-side, left-back, or left-bottom piping.

- 1) Insert the drain hose to a depth of 1-15/16 inches (50mm) or more so it will not be pulled out of the drain pipe.

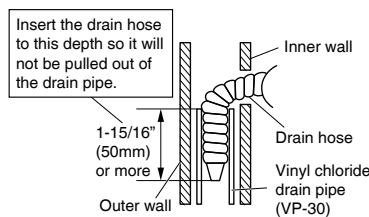

4. Wiring

Refer to the installation manual for the outdoor unit also.

⚠ WARNING

- Do not use tapped wires, extension cords, or starburst connections, as they may cause overheating, electric shock, or fire.
- Do not use locally purchased electrical parts inside the product. (Do not branch the power for the drain pump, etc., from the terminal block.) Doing so may cause electric shock or fire.
- Do not connect the power wire to the indoor unit. Doing so may cause electric shock or fire.

⚠ CAUTION

Recommend stranded cable for interunit wiring. Local code always supersedes recommendation.

- For stranded wires, make sure to use the round crimp-style terminal for connection to the power supply terminal block. Place the round crimp-style terminals on the wires up to the covered part and secure in place.

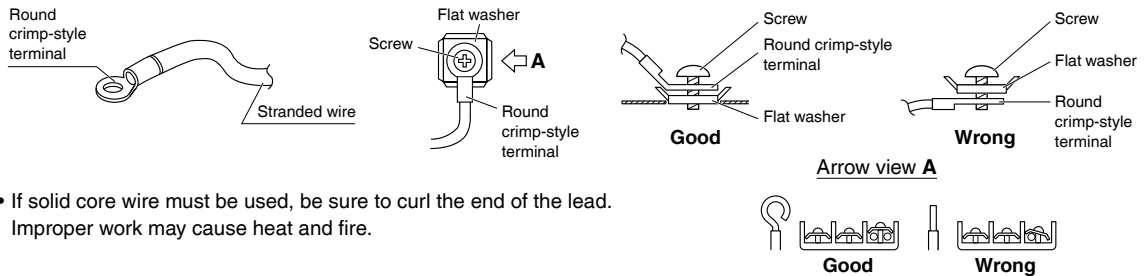

- If solid core wire must be used, be sure to curl the end of the lead. Improper work may cause heat and fire.

- 1) Remove the front grille. (Refer to “2. Removing and installing the front grille” on page 12.)
- 2) Remove the conduit mounting plate and then secure the conduit to the conduit mounting plate with the lock nut, as shown in the illustration.
- 3) Strip wire ends (3/4 inch (20mm)).
- 4) Match wire colors with terminal numbers on the indoor and outdoor unit’s terminal blocks and firmly secure the wires in the corresponding terminals with the screws.
- 5) Connect the ground wires to the corresponding terminals.
- 6) Pull the wires lightly to make sure they are securely connected.
- 7) Attach the conduit mounting plate.
- 8) Shape the wires so that the service lid fits securely.
- 9) Attach the front grille. (Refer to “2. Removing and installing the front grille” on page 12.)
- 10) Take care to ensure that all wiring between the indoor unit and the outdoor unit has a consistent connection. Any splices can cause communication errors.

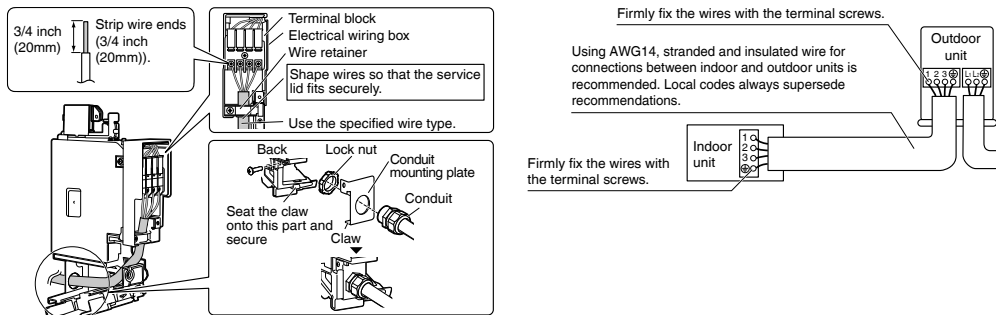

Indoor Unit Installation

5. Drain piping

- 1) Connect the drain hose, as shown below.
 - Avoid placing the end of the drain hose in a drainage location that could cause bad odors or corrosive gas to flow backward into the outlet.
 - The drainage water may change color due to bacteria or other organisms. Place in a location where the flow of drainage water will not cause a problem.
 - Minimize the number of bends in the drain hose as much as possible. If bending the drain hose, bend it gently.

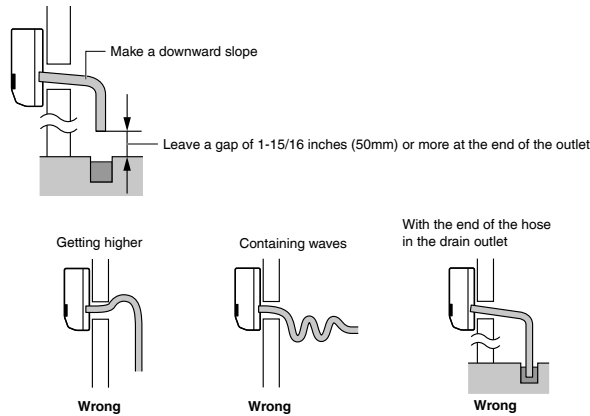

- 2) Remove the air filters and transfer some water to the indoor heat exchanger by pouring water into the drain pan.
- 3) Make sure that water flows out of the drain hose.

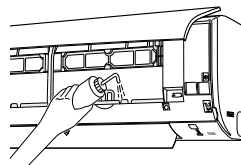

- 4) If drain hose extension or embedded drain piping is required, use appropriate parts that match the hose front end.
 - When drain hose requires extension, obtain an extension hose with an inner diameter of 5/8 inch (16mm). Be sure to thermally insulate the indoor section of the extension hose.

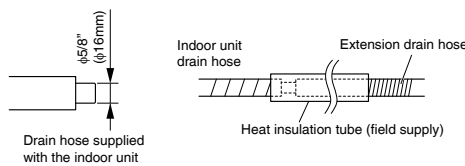

Refrigerant Piping Work

⚠ WARNING

- Do not apply mineral oil to the flare.
- Prevent mineral oil from getting into the system as this would reduce the service life of the units.
- Never use piping which has been used for previous installations. Only use parts which are delivered with this unit.
- Never install a dryer to this R32 unit in order to guarantee its service life.
- The drying material may dissolve and damage the system.
- Improper flaring may result in refrigerant gas leakage.

1. Flaring the pipe end

- 1) Cut the pipe end with a pipe cutter.
- 2) Remove burrs with the cut surface facing downward, so that the filings do not enter the pipe.

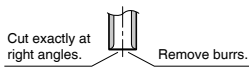

- 3) Put the flare nut on the pipe.
- 4) Flare the pipe.
- 5) Check that the flaring has been done correctly.

Flaring

Set exactly at the position shown below.

| Flare tool for R32 or R410A | Conventional flare tool | | |
|-----------------------------|---------------------------|---------------------------------|---------------------------------|
| | Clutch-type | Clutch-type (Rigid-type) | Wing-nut type (Imperial-type) |
| A | 0-0.020 inch (0-0.5mm) | 0.039-0.059 inch (1.0-1.5mm) | 0.059-0.079 inch (1.5-2.0mm) |

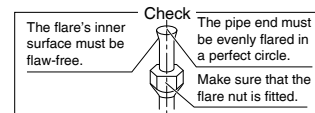

2. Refrigerant piping

⚠ CAUTION

- Use the flare nut fixed to the main unit. (This is to prevent the flare nut from cracking as a result of deterioration over time.)
- Use a torque wrench when tightening the flare nuts to prevent damage to the flare nuts and gas leakage.
- Excessive tightening of the flare nut can result in the flare nut cracking in the long term, leading to gas leakage.

- Align the centers of both flares and tighten the flare nuts 3 or 4 turns by hand, then tighten them fully with a spanner and a torque wrench.

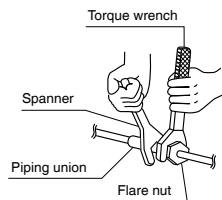
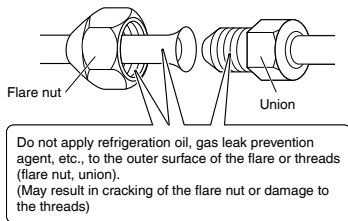

| | Piping size | Flare nut tightening torque |
|-------------|--------------------------|---|
| Gas side | O.D. 3/8 inch (9.5mm) | 24-1/8 – 29-1/2 lbf • ft (32.7-39.9N • m) |
| Liquid side | O.D. 1/4 inch (6.4mm) | 10-1/2 – 12-3/4 lbf • ft (14.2-17.2 N • m) |

Caution on piping handling

- Protect the open end of the pipe against dust and moisture.
- All pipe bends should be as gentle as possible. Use a pipe bender for bending.

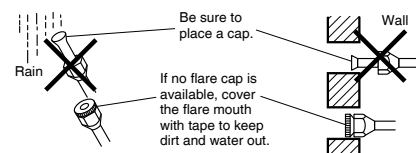

Refrigerant Piping Work

Selection of copper and heat insulation materials

When using commercial copper pipes and fittings, observe the following:

- Insulation material: Polyethylene foam
Heat transfer rate: 0.041 to 0.052W/mK (0.024 to 0.030Btu/ft^h°F (0.035 to 0.045kcal/mh°C))
Be sure to use insulation that is designed for use with HVAC Systems.
- ACR Copper only.

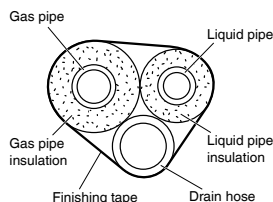

- Be sure to insulate both the gas and liquid piping and observe the insulation dimensions as below.

| | Piping size | Minimum bend radius | Piping thickness | Thermal insulation size | Thermal insulation thickness |
|-------------|-----------------------|----------------------------|-------------------------------|---------------------------------|------------------------------|
| Gas side | O.D. 3/8 inch (9.5mm) | 1-3/16 inch (30mm) or more | 0.031 inch (0.8mm) (C1220T-O) | I.D. 15/32-19/32 inch (12-15mm) | 13/32 inch (10mm) Min. |
| Liquid side | O.D. 1/4 inch (6.4mm) | 1-3/16 inch (30mm) or more | 0.031 inch (0.8mm) (C1220T-O) | I.D. 5/16-13/32 inch (8-10mm) | |

- Use separate thermal insulation pipes for gas and liquid refrigerant pipes.
- Using finishing tape, bundle and wrap the indoor unit piping and drain hose together so that the drain hose is below the other piping.

Installation Tips

1. Removing and installing the front panel

• **Removal method**

1) Place your fingers in the indentations on the main unit (one each on the left and right sides), and open the front panel until it stops.

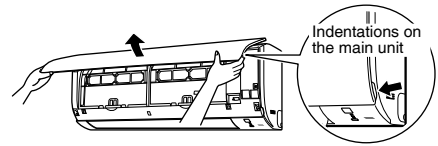

2) While pushing the left side front panel shaft outward, push up the front panel and remove it. (Remove the right side front panel shaft in the same manner.)

3) After removing both front panel shafts, pull the front panel toward yourself and remove it.

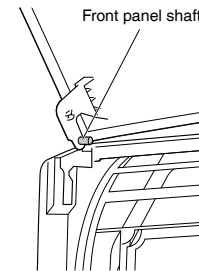

• **Installation method**

Align the front panel shaft of the front panel with the grooves of grille, and push all the way in, then close slowly.

Push the center of the lower panel surface firmly to engage the tabs.

2. Removing and installing the front grille

• **Removal method**

1) Remove the front panel and air filters.
2) Remove the 2 screws from the front grille.

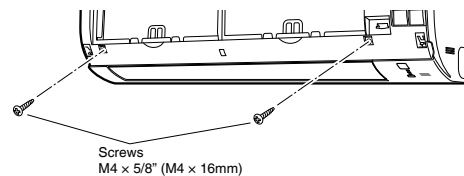

3) In front of the ○○○ mark on the front grille, there are 3 upper hooks. Lightly pull the front grille toward you with one hand, and push down on the hooks with the fingers of your other hand.

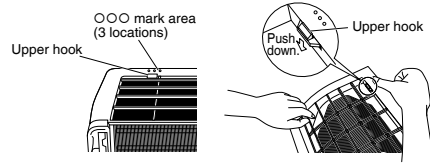

When there is insufficient work space because the unit is close to ceiling



CAUTION

Be sure to wear protection gloves.

Place both hands under the center of the front grille, and while pushing up, pull it toward you.

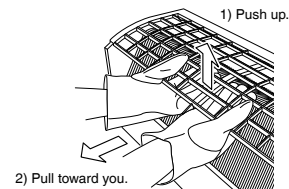





• **Installation method**

1) Install the front grille and firmly engage the upper hooks (3 locations).
2) Install 2 screws of the front grille.
3) Install the air filters and then mount the front panel.

Installation Tips

3. How to set the different addresses

When 2 indoor units are installed in one room, the 2 wireless remote controllers can be set for different addresses. Change the address setting of one of the 2 units. When cutting the jumper, be careful not to damage any of the surrounding parts.

- 1) Remove the battery cover on the remote controller and cut the address jumper.
- 2) Press ,  and  at the same time.
- 3) Press , then select  .
(The indoor unit OPERATION lamp will blink for about 1 minute.)
- 4) Press the indoor unit ON/OFF switch while the OPERATION lamp is blinking.

Remove the batteries before cutting the jumper.

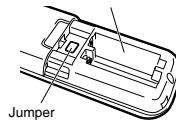

| | Address | |
|--------|---------|-----|
| | 1 | 2 |
| Jumper | EXIST | CUT |



- If setting could not be carried out completely while the OPERATION lamp was blinking, carry out the setting process once again from the beginning.
- After setting is complete, pressing  for about 5 seconds will cause the remote controller to return to the previous display.

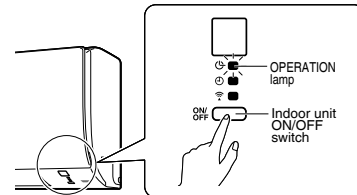

4. Pump down operation

In order to protect the environment, be sure to pump down when relocating or disposing of the unit.

For instructions on how to pump down, refer to the installation manual for the outdoor unit to be connected.

Forced cooling operation







For pair connections

■Using the indoor unit ON/OFF switch

Press the indoor unit ON/OFF switch for at least 5 seconds. (The operation will start.)

- Forced cooling operation will stop automatically after about 15 minutes.
To stop the operation, press the indoor unit ON/OFF switch.

■Using the indoor unit's remote controller

- 1) Press ,  and  at the same time.
 - 2) Press , then select  .
 - 3) Press  to turn on the system.
- Forced cooling operation will stop automatically after about 30 minutes.
To stop the operation, press .

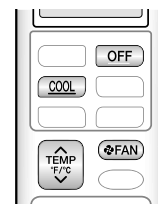

For multi connections

For instructions on how to perform forced cooling operation, refer to the installation manual for the outdoor unit.

Trial Operation and Testing

1. Trial operation and testing

- Trial operation should be carried out in either COOL or HEAT operation.

1-1. Measure the supply voltage and make sure that it is within the specified range.







1-2. In COOL operation, select the lowest programmable temperature; in HEAT operation, select the highest programmable temperature.

1-3. Carry out the trial operation following the instructions in the operation manual to ensure that all functions and parts, such as the movement of the flap, are working properly.

- To protect the air conditioner, restart operation is disabled for 3 minutes after the system has been turned off.

1-4. After trial operation is complete, set the temperature to a normal level (78°F to 82°F (26°C to 28°C) in COOL operation, 68°F to 75°F (20°C to 24°C) in HEAT operation).

- When operating the air conditioner in COOL operation in winter, or HEAT operation in summer, set it to the trial operation mode using the following method.

- 1) Press ,  and  at the same time.
- 2) Press , then select 7°, press .
- 3) Press  or  to turn on the system.

- Trial operation will stop automatically after about 30 minutes. To stop the operation, press .
- Some of the functions cannot be used in the trial operation mode.

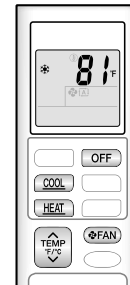

- The air conditioner draws a small amount of power in its standby mode. If the system is not to be used for some time after installation, shut off the circuit breaker to eliminate unnecessary power consumption.
- If the circuit breaker trips to shut off the power to the air conditioner, the system will restore the original operation mode when the circuit breaker is turned on again.

2. Test items

| Test items | Symptom | Check |
|--|--|-------|
| Indoor and outdoor units are installed securely. | Fall, vibration, noise | |
| No refrigerant gas leaks. | Incomplete cooling/heating function | |
| Refrigerant gas and liquid pipes and indoor drain hose extension are thermally insulated. | Water leakage | |
| Draining line is properly installed. | Water leakage | |
| System is properly grounded. | Electrical leakage | |
| Only specified wires are used for all wiring, and all wires are connected correctly. | No operation or burn damage | |
| Indoor or outdoor unit's air inlet or air outlet are unobstructed. | Incomplete cooling/heating function | |
| Stop valves are opened. | Incomplete cooling/heating function | |
| Indoor unit properly receives remote control commands. | No operation | |
| Explain to the user that when using a smartphone for operation, it is necessary to prepare a repeater, or similar device, if the signal from the wireless LAN router is weak near the air conditioner. | Air conditioner not responding to smartphone | |

1.2 FTXV15/18/24

Contents

| | | | |
|---|----------|--|-----------|
| Safety Considerations | 1 | Refrigerant Piping Work | 10 |
| Accessories | 3 | 1. Flaring the pipe end..... | 10 |
| Choosing an Installation Site | 3 | 2. Refrigerant piping | 10 |
| 1. Indoor unit | 3 | Installation Tips | 12 |
| 2. Wireless remote controller..... | 3 | 1. Removing and installing the front panel | 12 |
| Indoor Unit Installation Diagram | 4 | 2. Removing and installing the front grille..... | 12 |
| Indoor Unit Installation | 5 | 3. How to set the different addresses | 13 |
| 1. Installing the mounting plate..... | 5 | 4. Pump down operation..... | 13 |
| 2. Drilling a wall hole and installing wall embedded pipe ... | 5 | Trial Operation and Testing | 14 |
| 3. Installing the indoor unit | 6 | 1. Trial operation and testing | 14 |
| 4. Wiring | 8 | 2. Test items | 14 |
| 5. Drain piping | 9 | | |



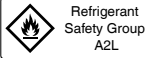

The pictures in this document are for illustrative purposes only.

Safety Considerations

Refer also to the General Safety Considerations in the separate booklet.

| | |
|---|---|
|  | Read the precautions in this manual carefully before operating the unit. |
|  | This appliance is filled with R32. |

Read these **Safety Considerations for Installation** carefully before installing an air conditioner or heat pump. After completing the installation, make sure that the unit operates properly during the startup operation. Instruct the user on how to operate and maintain the unit. Inform users that they should store this installation manual with the operation manual for future reference. Always use a licensed installer or contractor to install this product. Improper installation can result in water or refrigerant leakage, electric shock, fire, or explosion. Meanings of **DANGER**, **WARNING**, **CAUTION**, and **NOTE** Symbols:

-  **DANGER** Indicates an imminently hazardous situation which, if not avoided, will result in death or serious injury.
-  **WARNING** Indicates a potentially hazardous situation which, if not avoided, could result in death or serious injury.
-  **CAUTION** Indicates a potentially hazardous situation which, if not avoided, may result in minor or moderate injury. It may also be used to alert against unsafe practices.
-  **NOTE** Indicates situations that may result in equipment or property-damage accidents only.

DANGER

- Refrigerant gas is heavier than air and replaces oxygen. A massive leak can lead to oxygen depletion, especially in basements, and an asphyxiation hazard could occur leading to serious injury or death.
- Do not ground units to water pipes, gas pipes, telephone wires, or lightning rods as incomplete grounding can cause a severe shock hazard resulting in severe injury or death. Additionally, grounding to gas pipes could cause a gas leak and potential explosion causing severe injury or death.

- If refrigerant gas leaks during installation, ventilate the area immediately. Refrigerant gas may produce toxic gas if it comes into contact with fire. Exposure to this gas could cause severe injury or death.
- After completing the installation work, check that the refrigerant gas does not leak throughout the system.
- Do not install unit in an area where flammable materials are present due to risk of explosions that can cause serious injury or death.
- Safely dispose all packing and transportation materials in accordance with federal/state/local laws or ordinances. Packing materials such as nails and other metal or wood parts, including plastic packing materials used for transportation may cause injury or death by suffocation.
- All possible ignition sources, including cigarette smoking, should be kept sufficiently far away from the site of installation, repairing, removing and disposal.

WARNING

- Only qualified personnel licensed or certified in their jurisdiction must carry out the installation work. Installation must be done in accordance with this installation manual. Improper installation may result in water leakage, electric shock, or fire.
- Pipe-work including piping material, pipe routing, and installation shall include protection from physical damage in operation and service, and be in compliance with national and local codes and standards, such as ASHRAE 15, ASHRAE 15.2, IAPMO Uniform Mechanical Code, ICC International Mechanical Code, or CSA B52. All field joints shall be accessible for inspection prior to being covered or enclosed.
- When installing the unit in a small room, take measures to keep the refrigerant concentration from exceeding allowable safety limits. Excessive refrigerant leaks, in the event of an accident in a closed ambient space, can lead to oxygen deficiency.
- Use only specified accessories and parts for installation work. Failure to use specified parts may result in water leakage, electric shock, fire, or the unit falling.
- Install the air conditioner or heat pump on a foundation strong enough that it can withstand the weight of the unit. A foundation of insufficient strength may result in the unit falling and causing injury.

- Take into account strong winds, typhoons, or earthquakes when installing. Improper installation may result in the unit falling and causing accidents.
- Make sure that a separate power supply circuit is provided for this unit and that all electrical work is carried out by qualified personnel licensed or certified in their jurisdiction according to local, state, and national regulations. An insufficient power supply capacity or improper electrical construction may lead to electric shock or fire.
- Make sure that all wiring is secured, that specified wires are used, and that no external forces act on the terminal connections or wires. Improper connections or installation may result in fire.
- When wiring, position the wires so that the service lid can be securely fastened. Improper positioning of the service lid may result in electric shock, fire, or the terminals overheating.
- Before touching electrical parts, turn off the unit.
- The circuit must be protected with safety devices in accordance with local and national codes, i.e. a circuit breaker.
- Securely fasten the outdoor unit service lid. If the service lid is not installed properly, dust or water may enter the outdoor unit causing fire or electric shock.
- When installing or relocating the system, keep the refrigerant circuit free from substances other than the specified refrigerant (R32) such as air. Any presence of air or other foreign substance in the refrigerant circuit can cause an abnormal pressure rise or rupture, which may result in equipment damage and even injury.
- Do not change the setting of the protection devices. If the pressure switch, thermal switch, or other protection device is shorted and operated forcibly, or parts other than those specified by Daikin are used, fire or explosion may occur.
- Do not use means to accelerate the defrosting process (if possible) or to clean, other than those recommended by the manufacturer.
- The appliance must be stored in a room without continuously operating ignition sources (for example: open flames, an operating gas appliance or an operating electric heater).
- Do not pierce or burn.
- Be aware that refrigerants may not contain an odor.
- Comply with national gas regulations.
- The indoor equipment and pipes shall be securely mounted and guarded such that accidental rupture of equipment cannot occur from such events as moving furniture or reconstruction activities.

⚠ CAUTION

- Do not touch the switch with wet fingers. Touching a switch with wet fingers can cause electric shock.
- Do not allow children to play on or around the unit to prevent injury.
- Wear adequate personal protective equipment (protective gloves, safety glasses,...) when installing, maintaining or servicing the system.
- The heat exchanger fins are sharp enough to cut. To avoid injury, wear gloves or cover the fins while working around them.
- Do not touch the refrigerant pipes during and immediately after operation as the refrigerant pipes may be hot or cold, depending on the condition of the refrigerant flowing through the refrigerant piping, compressor, and other refrigerant cycle parts. Your hands may suffer burns or frostbite if you touch the refrigerant pipes. To avoid injury, give the pipes time to return to normal temperature or, if you must touch them, be sure to wear proper gloves.
- Install drain piping to ensure proper drainage. Improper drain piping may result in water leakage and property damage.
- Insulate piping to prevent condensation.







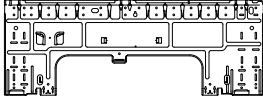

- Be careful when transporting the product.
- Do not turn off the power immediately after stopping operation. Always wait for at least 5 minutes before turning off the power. Otherwise, water leakage may occur.
- Do not use a charging cylinder. Using a charging cylinder may cause the refrigerant to deteriorate.
- Refrigerant R32 in the system must be kept clean, dry, and tight.
 - (a) Clean and Dry -- Foreign materials (including mineral oils such as SUNISO oil or moisture) should be prevented from getting into the system.
 - (b) Tight -- R32 does not contain any chlorine, does not destroy the ozone layer, and does not reduce the earth's protection against harmful ultraviolet radiation. R32 can contribute to the greenhouse effect if it is released. Therefore take proper measures to check for the tightness of the refrigerant piping installation. Read the chapter *Refrigerant Piping Work* and follow the procedures.
- The indoor unit is for R32. See the catalog for outdoor models that can be connected. Normal operation is not possible when connected to non-compatible outdoor units.
- Remote controller (wireless kit) transmitting distance can be shorter than expected in rooms with electronic fluorescent lamps (inverter or rapid start types). Install the indoor unit far away from fluorescent lamps as much as possible.
- Indoor units are for indoor installation only. Outdoor units can be installed either outdoors or indoors.
- Do not install the air conditioner or heat pump in the following locations:
 - (a) Where a mineral oil mist or oil spray or vapor is produced, for example, in a kitchen. Plastic parts may deteriorate and fall off or result in water leakage.
 - (b) Where corrosive gas, such as sulfurous acid gas, is produced. Corroding copper pipes or soldered parts may result in refrigerant leakage.
 - (c) Near machinery emitting electromagnetic waves. Electromagnetic waves may disturb the operation of the control system and cause the unit to malfunction.
 - (d) Where flammable gas may leak, where there is carbon fiber, or ignitable dust suspension in the air, or where volatile flammables such as thinner or gasoline are handled. Operating the unit in such conditions can cause a fire.
- Take adequate measures to prevent the outdoor unit from being used as a shelter by small animals. Small animals making contact with electrical parts can cause malfunctions, smoke, or fire. Instruct the user to keep the area around the unit clean.
- Servicing shall be performed only as recommended by the manufacturer and licensed or certified in their jurisdiction.

⚠ NOTE

- The indoor unit should be positioned where the unit and interunit wires (outdoor to indoor) are at least 3.3ft (1m) away from any televisions or radios. (The unit may cause interference with the picture or sound.) Depending on the radio waves, a distance of 3.3ft (1m) may not be sufficient to eliminate the noise.
- Dismantling the unit, treatment of the refrigerant, oil and additional parts must be done in accordance with the relevant local, state, and national regulations.
- Only use tools for R32, such as a gauge manifold, charge hose, gas leak detector, reverse flow check valve, refrigerant charge base, vacuum gauge, or refrigerant recovery equipment.
- If the conventional refrigerant and refrigerator oil are mixed in R32, the refrigerant may deteriorate.
- As maximum allowable pressure is 604psi (4.17MPa), the wall thickness of field-installed pipes should be selected in accordance with the relevant local, state, and national regulations.

FTN006(R32)-U

Accessories

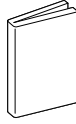
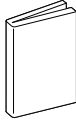
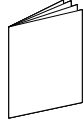
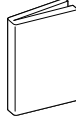
| | | | | | |
|--|----------|---|----------|---|---------------|
| <p>A Mounting plate</p>  | <p>1</p> | <p>B Mounting plate fixing screw M4 × 1" (M4 × 25mm)</p>  | <p>7</p> | <p>C Titanium apatite deodorizing filter</p>  | <p>2 each</p> |
| <p>D Wireless remote controller</p>  | <p>1</p> | <p>E Remote controller holder</p>  | <p>1</p> | <p>F Remote controller holder fixing screw M3 × 13/16" (M3 × 20mm)</p>  | <p>2</p> |
| <p>G Dry battery AAA. LR03 (alkaline)</p>  | <p>2</p> | <p>H Indoor unit fixing screw M4 × 1/2" (M4 × 12mm)</p>  | <p>2</p> | <p>J Insulation tape</p>  | <p>1</p> |
| <p>K Operation manual</p>  | <p>1</p> | <p>L Installation manual</p>  | <p>1</p> | <p>M Warranty</p>  | <p>1</p> |
| <p>N General safety considerations</p>  | <p>1</p> | | | | |

Choosing an Installation Site

- Before choosing the installation site, obtain user approval.

1. Indoor unit

- The indoor unit should be positioned in a place where:
 - 1) the restrictions on the installation requirements specified in “Indoor Unit Installation Diagram” on page 4 are met,
 - 2) both the air inlet and air outlet are unobstructed,
 - 3) the unit is not exposed to direct sunlight,
 - 4) drainage occurs easily,
 - 5) the unit is away from sources of heat or steam,
 - 6) there is no source of machine oil vapor (this may shorten the indoor unit service life),
 - 7) cool/warm air is circulated throughout the room,
 - 8) the unit is away from electronic ignition type fluorescent lamps (inverter or rapid start type) as they may affect the remote controller range,
 - 9) the unit is at least 3.3ft (1m) away from any television or radio set (the unit may cause interference with the picture or sound),
 - 10) no laundry equipment is nearby,
 - 11) the signal strength of the router is stable (insufficient signal strength can prevent stable communication).

2. Wireless remote controller

- Turn on all the fluorescent lamps in the room, if any, and find a location where the remote controller signals are properly received by the indoor unit (within 23ft (7m)).

Indoor Unit Installation Diagram

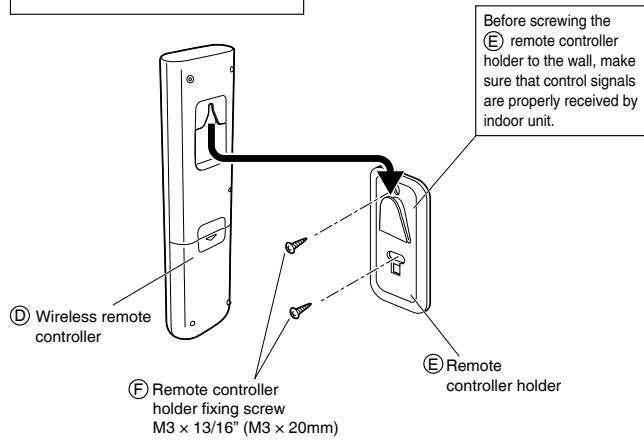
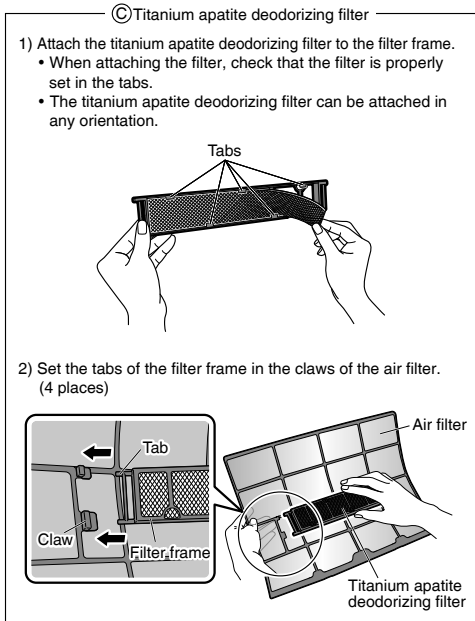
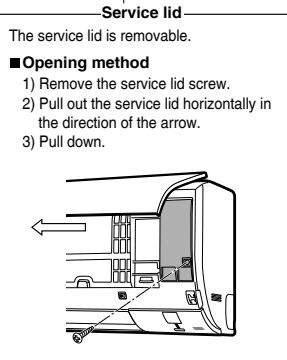
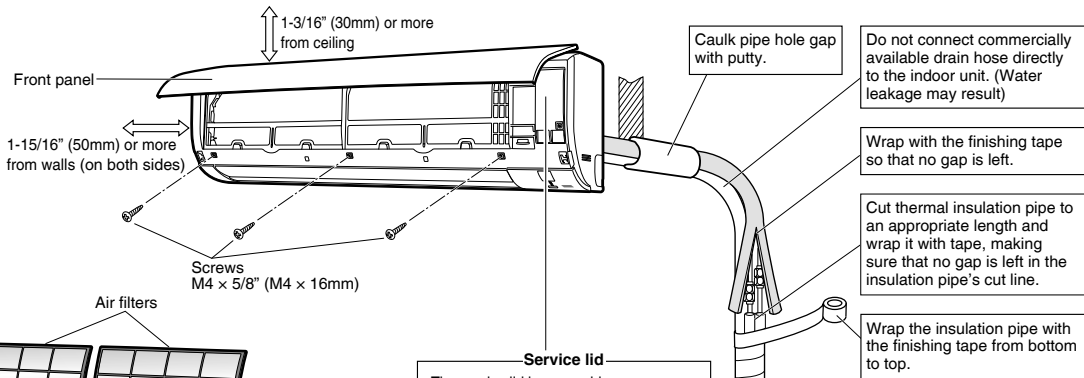
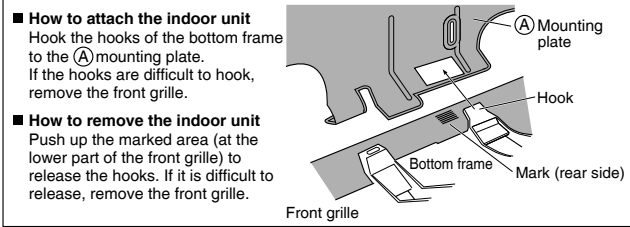
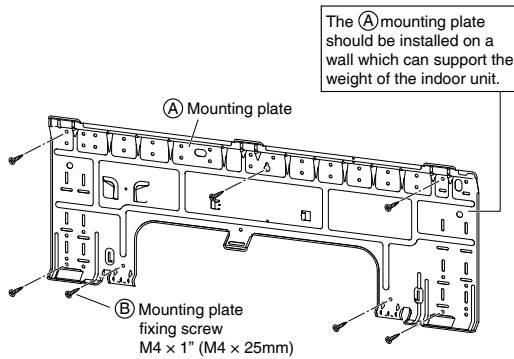

Indoor Unit Installation

1. Installing the mounting plate

- The mounting plate should be installed on a wall which can support the weight of the indoor unit.
 - Temporarily secure the mounting plate to the wall, make sure that the panel is completely level, and mark the drilling points on the wall.
 - Secure the mounting plate to the wall with screws.

Recommended mounting plate retention spots and dimensions

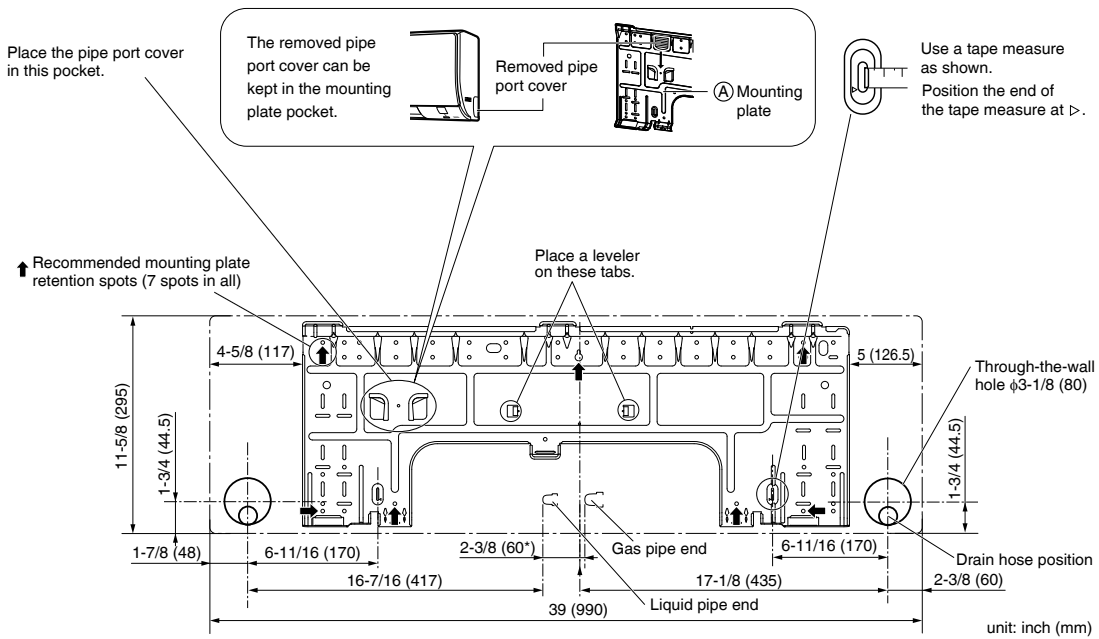

* Depending on the model, the actual distance between the liquid pipe end and gas pipe end may differ from the distance between those symbols on the mounting plate (the distance listed in this manual). Always measure the actual distance between the liquid pipe end and gas pipe end before installing refrigerant pipes.

2. Drilling a wall hole and installing wall embedded pipe

⚠ WARNING

For metal frame or metal board walls, be sure to use a wall embedded pipe and wall hole cover in the feed-through hole to prevent possible heat, electric shock, or fire.

- Be sure to caulk the gaps around the pipes with caulking material to prevent condensation.
 - Drill a feed-through hole with a ϕ 3-1/8 inch (80mm) diameter through the wall at a downward angle toward the outside.
 - Insert a wall embedded pipe into the hole.
 - Insert a wall hole cover into wall pipe.
 - After completing refrigerant piping, wiring, and drain piping, caulk the pipe hole gap with putty.

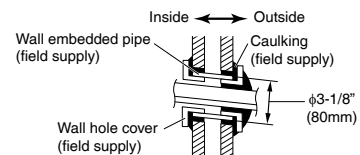

Even if a wall hole cover is not used, caulk both the outdoor and indoor sides with putty.

3. Installing the indoor unit

In the case of bending or curing refrigerant pipes, keep the following precautions in mind.
Abnormal sound may be generated if improper work is conducted.

- Do not strongly press the refrigerant pipes onto the bottom frame.
- Do not strongly press the refrigerant pipes on the front grille, either.

3-1. Right-side, right-back, or right-bottom piping

- 1) Attach the drain hose to the underside of the refrigerant pipes with adhesive vinyl tape.
- 2) Wrap the refrigerant pipes and drain hose together with ② insulation tape.

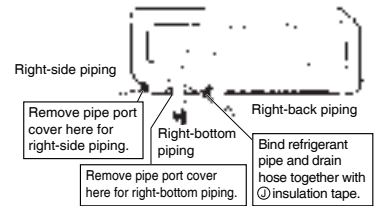

- 3) Pass the drain hose and refrigerant pipes through the wall hole, then position the indoor unit on the ① mounting plate hooks by using the △ markings at the top of the indoor unit as a guide.

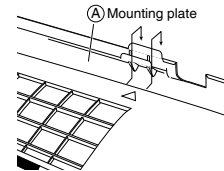

- 4) Open the front panel (Refer to "Installation Tips" on page 12), then open the service lid (Refer to "Indoor Unit Installation Diagram" on page 4).
- 5) Pass the inter-unit wire from the outdoor unit through the feed-through wall hole and pass to the front of indoor unit from the back. Then pull them at front side. Bend the ends of cable tie wires upward for easier work in advance. (If the interunit wire ends are to be stripped first, bundle wire ends with adhesive tape.)
- 6) Press the bottom frame of the indoor unit with both hands until it is firmly caught by the ① mounting plate hooks. Make sure the wire leads do not catch on the edge of the indoor unit.

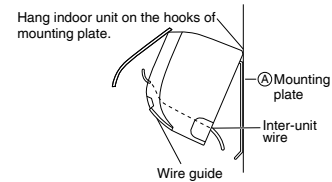

3-2. Left-side, left-back, or left-bottom piping

- 1) Switch around the drain plug and drain hose.

How to switch around the drain plug and drain hose

- 1) Remove the fixing screw and pull out the drain hose.
 - ① Remove fixing screw.
 - ② Pull out drain hose.
- 3) Switch around the drain hose and drain plug.
 - Push the drain plug all the way in using a hexagonal wrench (3/16 inch (4mm)).
 - Do not apply lubricating oil (refrigerant oil) to the drain plug when inserting it. The application of lubrication oil to the drain plug will deteriorate the plug to cause drain leakage from the plug.
 - Insert a hexagonal wrench (3/16 inch (4mm)).
 - No gap
- Insert drain hose securely and fix in place with fixing screw.

Indoor Unit Installation

- 2) Attach the drain hose to the underside of the refrigerant pipes with adhesive vinyl tape.

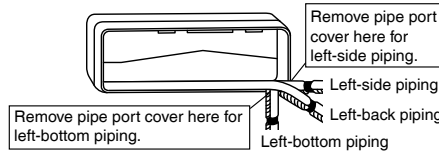

- 3) Shape the refrigerant pipes along the pipe path marking on the (A) mounting plate.
- 4) Pass the drain hose and refrigerant pipes through the wall hole, then position the indoor unit on the (A) mounting plate hooks, using the △ markings at the top of the indoor unit as a guide.

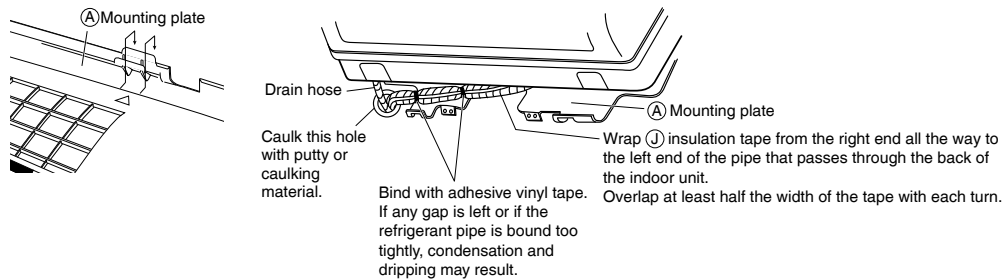

- 5) Open the front panel (Refer to "Installation Tips" on page 12), then open the service lid (Refer to "Indoor Unit Installation Diagram" on page 4).
- 6) Pass the inter-unit wire from the outdoor unit through the feed-through wall hole and pass to the front of indoor unit from the back. Then pull them at front side. Bend the ends of cable tie wires upward for easier work in advance. (If the interunit wire ends are to be stripped first, bundle wire ends with adhesive tape.)
- 7) Connect the refrigerant pipes.
- 8) In case of pulling the drain hose through the back of the indoor unit, wrap the refrigerant pipes and drain hose together with (C) insulation tape as shown in the figure below.
- 9) Press the bottom frame of the indoor unit with both hands until it is firmly caught by the (A) mounting plate hooks. Make sure that the wires do not catch on the edge of the indoor unit.

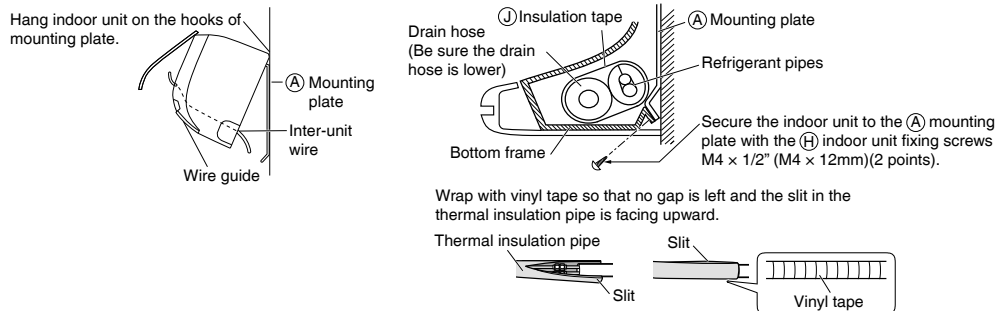

3-3. Wall embedded piping

Follow the instructions given under left-side, left-back, or left-bottom piping.

- 1) Insert the drain hose to a depth of 1-15/16 inches (50mm) or more so it will not be pulled out of the drain pipe.

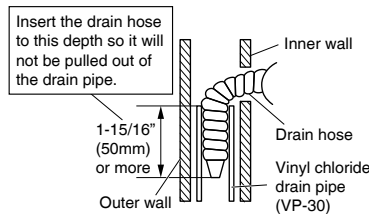

4. Wiring

Refer to the installation manual for the outdoor unit also.

⚠ WARNING

- Do not use tapped wires, extension cords, or starburst connections, as they may cause overheating, electric shock, or fire.
- Do not use locally purchased electrical parts inside the product. (Do not branch the power for the drain pump, etc., from the terminal block.) Doing so may cause electric shock or fire.
- Do not connect the power wire to the indoor unit. Doing so may cause electric shock or fire.

⚠ CAUTION

Recommend stranded cable for interunit wiring. Local code always supersedes recommendation.

- For stranded wires, make sure to use the round crimp-style terminal for connection to the power supply terminal block. Place the round crimp-style terminals on the wires up to the covered part and secure in place.

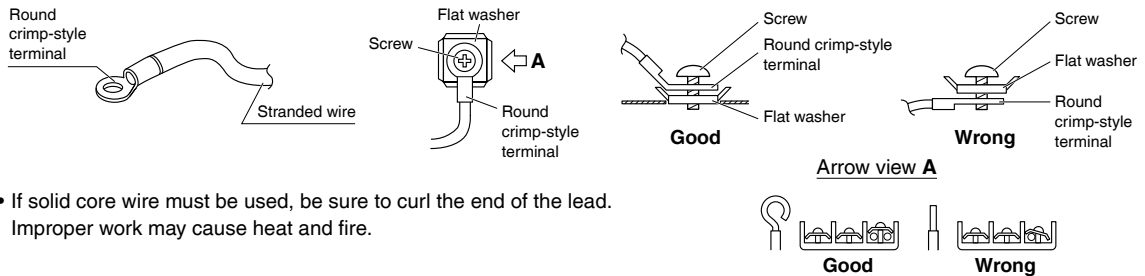

- If solid core wire must be used, be sure to curl the end of the lead. Improper work may cause heat and fire.

- 1) Remove the front grille. (Refer to “2. Removing and installing the front grille” on page 12.)
- 2) Remove the conduit mounting plate and then secure the conduit to the conduit mounting plate with the lock nut, as shown in the illustration.
- 3) Strip wire ends (3/4 inch (20mm)).
- 4) Match wire colors with terminal numbers on the indoor and outdoor unit’s terminal blocks and firmly secure the wires in the corresponding terminals with the screws.
- 5) Connect the ground wires to the corresponding terminals.
- 6) Pull the wires lightly to make sure they are securely connected.
- 7) Attach the conduit mounting plate.
- 8) Shape the wires so that the service lid fits securely.
- 9) Attach the front grille. (Refer to “2. Removing and installing the front grille” on page 12.)
- 10) Take care to ensure that all wiring between the indoor unit and the outdoor unit has a consistent connection. Any splices can cause communication errors.

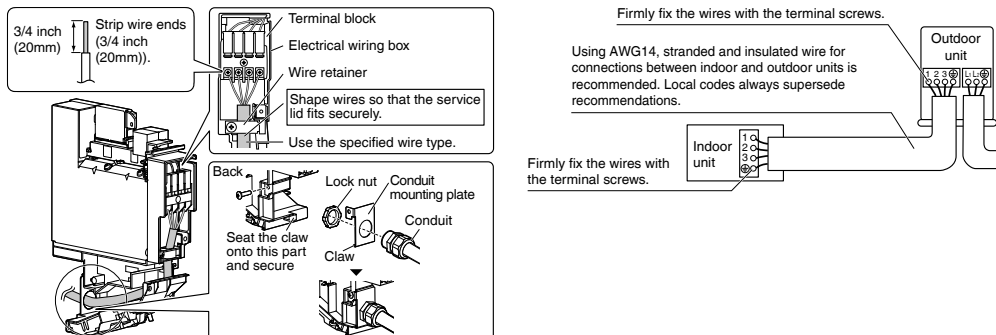

Indoor Unit Installation

5. Drain piping

- 1) Connect the drain hose, as shown below.
 - Avoid placing the end of the drain hose in a drainage location that could cause bad odors or corrosive gas to flow backward into the outlet.
 - The drainage water may change color due to bacteria or other organisms. Place in a location where the flow of drainage water will not cause a problem.
 - Minimize the number of bends in the drain hose as much as possible. If bending the drain hose, bend it gently.

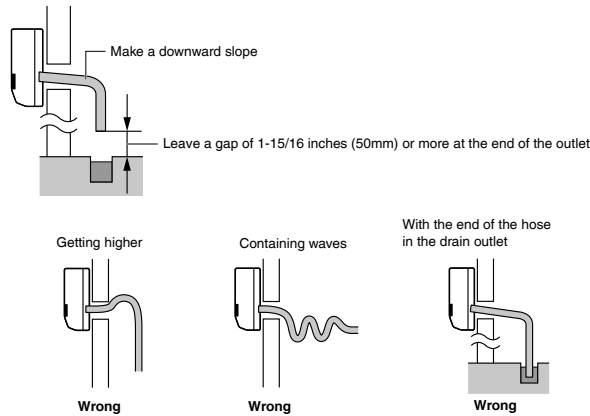

- 2) Remove the air filters and transfer some water to the indoor heat exchanger by pouring water into the drain pan.
- 3) Make sure that water flows out of the drain hose.

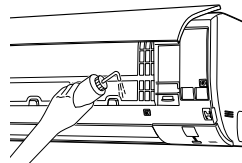

- 4) If drain hose extension or embedded drain piping is required, use appropriate parts that match the hose front end.
 - When drain hose requires extension, obtain an extension hose with an inner diameter of 5/8 inch (16mm). Be sure to thermally insulate the indoor section of the extension hose.

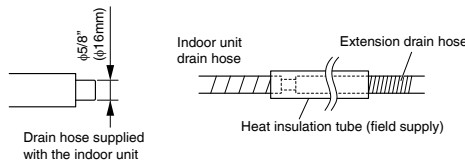

Refrigerant Piping Work

⚠ WARNING

- Do not apply mineral oil to the flare.
- Prevent mineral oil from getting into the system as this would reduce the service life of the units.
- Never use piping which has been used for previous installations. Only use parts which are delivered with this unit.
- Never install a dryer to this R32 unit in order to guarantee its service life.
- The drying material may dissolve and damage the system.
- Improper flaring may result in refrigerant gas leakage.

1. Flaring the pipe end

- 1) Cut the pipe end with a pipe cutter.
- 2) Remove burrs with the cut surface facing downward, so that the filings do not enter the pipe.

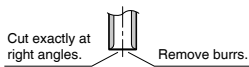

- 3) Put the flare nut on the pipe.
- 4) Flare the pipe.
- 5) Check that the flaring has been done correctly.

Flaring

Set exactly at the position shown below.

| Flare tool for R32 or R410A | Conventional flare tool | |
|-----------------------------|------------------------------|-------------------------------|
| | Clutch-type | Wing-nut type (Imperial-type) |
| 0-0.020 inch (0-0.5mm) | 0.039-0.059 inch (1.0-1.5mm) | 0.059-0.079 inch (1.5-2.0mm) |

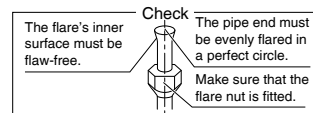

2. Refrigerant piping

⚠ CAUTION

- Use the flare nut fixed to the main unit. (This is to prevent the flare nut from cracking as a result of deterioration over time.)
- Use a torque wrench when tightening the flare nuts to prevent damage to the flare nuts and gas leakage.
- Excessive tightening of the flare nut can result in the flare nut cracking in the long term, leading to gas leakage.

- Align the centers of both flares and tighten the flare nuts 3 or 4 turns by hand, then tighten them fully with a spanner and a torque wrench.

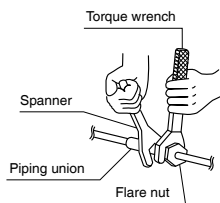
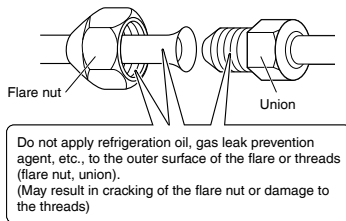

| | Piping size | Flare nut tightening torque |
|-------------|------------------------|--|
| Gas side | O.D. 1/2 inch (12.7mm) | 36-1/2 – 44-1/2 lbf • ft (49.5-60.3 N • m) |
| | O.D. 5/8 inch (15.9mm) | 45-5/8 – 55-5/8 lbf • ft (61.8-75.4 N • m) |
| Liquid side | O.D. 1/4 inch (6.4mm) | 10-1/2 – 12-3/4 lbf • ft (14.2-17.2 N • m) |

Caution on piping handling

- Protect the open end of the pipe against dust and moisture.
- All pipe bends should be as gentle as possible. Use a pipe bender for bending.

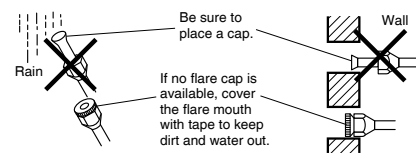

Refrigerant Piping Work

Selection of copper and heat insulation materials

When using commercial copper pipes and fittings, observe the following:

- Insulation material: Polyethylene foam
Heat transfer rate: 0.041 to 0.052W/mK (0.024 to 0.030Btu/ft^h°F (0.035 to 0.045kcal/mh°C))
Be sure to use insulation that is designed for use with HVAC Systems.
- ACR Copper only.

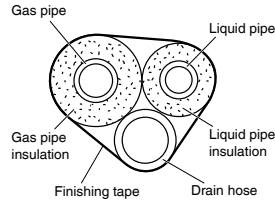

- Be sure to insulate both the gas and liquid piping and observe the insulation dimensions as below.

| | Piping size | Minimum bend radius | Piping thickness | Thermal insulation size | Thermal insulation thickness |
|-------------|------------------------|-----------------------------|-------------------------------|-------------------------------|------------------------------|
| Gas side | O.D. 1/2 inch (12.7mm) | 1-9/16 inch (40mm) or more | 0.031 inch (0.8mm) (C1220T-O) | I.D. 9/16-5/8 inch (14-16mm) | 13/32 inch (10mm) Min. |
| | O.D. 5/8 inch (15.9mm) | 1-15/16 inch (50mm) or more | 0.039 inch (1.0mm) (C1220T-O) | I.D. 5/8-13/16 inch (16-20mm) | |
| Liquid side | O.D. 1/4 inch (6.4mm) | 1-3/16 inch (30mm) or more | 0.031 inch (0.8mm) (C1220T-O) | I.D. 5/16-13/32 inch (8-10mm) | |

- Use separate thermal insulation pipes for gas and liquid refrigerant pipes.
- Using finishing tape, bundle and wrap the indoor unit piping and drain hose together so that the drain hose is below the other piping.

Installation Tips

1. Removing and installing the front panel

• **Removal method**

1) Place your fingers in the indentations on the main unit (one each on the left and right sides), and open the front panel until it stops.

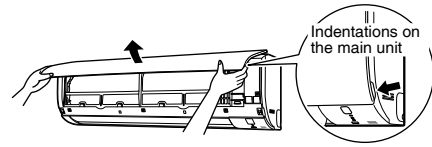

2) While pushing the left side front panel shaft outward, push up the front panel and remove it. (Remove the right side front panel shaft in the same manner.)

3) After removing both front panel shafts, pull the front panel toward yourself and remove it.

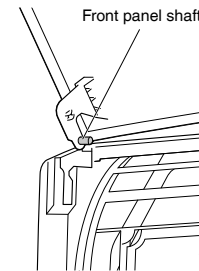

• **Installation method**

Align the front panel shaft of the front panel with the grooves of grille, and push all the way in, then close slowly.

Push the center of the lower panel surface firmly to engage the tabs.

2. Removing and installing the front grille

• **Removal method**

1) Remove the front panel and air filters.
2) Remove the 3 screws from the front grille.

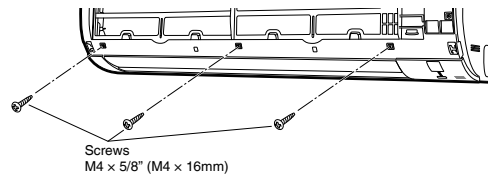

3) In front of the ○○○ mark on the front grille, there are 3 upper hooks. Lightly pull the front grille toward you with one hand, and push down on the hooks with the fingers of your other hand.

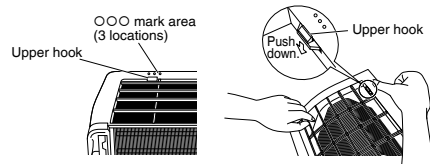

When there is insufficient work space because the unit is close to ceiling

⚠ CAUTION

Be sure to wear protection gloves.

Place both hands under the center of the front grille, and while pushing up, pull it toward you.

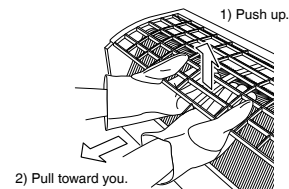





• **Installation method**

1) Install the front grille and firmly engage the upper hooks (3 locations).
2) Install 3 screws of the front grille.
3) Install the air filters and then mount the front panel.

Installation Tips

3. How to set the different addresses

When 2 indoor units are installed in one room, the 2 wireless remote controllers can be set for different addresses. Change the address setting of one of the 2 units. When cutting the jumper, be careful not to damage any of the surrounding parts.

- 1) Remove the battery cover on the remote controller and cut the address jumper.
- 2) Press ,  and  at the same time.
- 3) Press , then select  .
(The indoor unit OPERATION lamp will blink for about 1 minute.)
- 4) Press the indoor unit ON/OFF switch while the OPERATION lamp is blinking.

Remove the batteries before cutting the jumper.

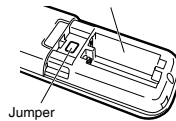

Jumper

| | Address | |
|--------|---------|-----|
| | 1 | 2 |
| Jumper | EXIST | CUT |



- If setting could not be carried out completely while the OPERATION lamp was blinking, carry out the setting process once again from the beginning.
- After setting is complete, pressing  for about 5 seconds will cause the remote controller to return to the previous display.

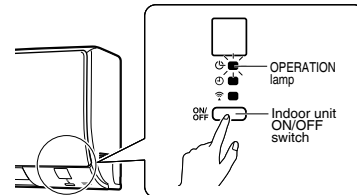

4. Pump down operation

In order to protect the environment, be sure to pump down when relocating or disposing of the unit.

For instructions on how to pump down, refer to the installation manual for the outdoor unit to be connected.

Forced cooling operation

For pair connections



■Using the indoor unit ON/OFF switch

Press the indoor unit ON/OFF switch for at least 5 seconds. (The operation will start.)

- Forced cooling operation will stop automatically after about 15 minutes.
To stop the operation, press the indoor unit ON/OFF switch.

■Using the indoor unit's remote controller

1) Press ,  and  at the same time.

2) Press , then select  .

3) Press  to turn on the system.

- Forced cooling operation will stop automatically after about 30 minutes.
To stop the operation, press .

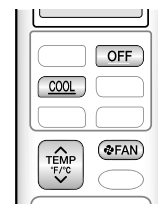

For multi connections

For instructions on how to perform forced cooling operation, refer to the installation manual for the outdoor unit.

Trial Operation and Testing

1. Trial operation and testing

- Trial operation should be carried out in either COOL or HEAT operation.

1-1. Measure the supply voltage and make sure that it is within the specified range.







1-2. In COOL operation, select the lowest programmable temperature; in HEAT operation, select the highest programmable temperature.

1-3. Carry out the trial operation following the instructions in the operation manual to ensure that all functions and parts, such as the movement of the flap, are working properly.

- To protect the air conditioner, restart operation is disabled for 3 minutes after the system has been turned off.

1-4. After trial operation is complete, set the temperature to a normal level (78°F to 82°F (26°C to 28°C) in COOL operation, 68°F to 75°F (20°C to 24°C) in HEAT operation).

- When operating the air conditioner in COOL operation in winter, or HEAT operation in summer, set it to the trial operation mode using the following method.

- 1) Press ,  and  at the same time.
- 2) Press , then select 7°, press .
- 3) Press  or  to turn on the system.

- Trial operation will stop automatically after about 30 minutes. To stop the operation, press .
- Some of the functions cannot be used in the trial operation mode.

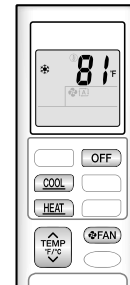

- The air conditioner draws a small amount of power in its standby mode. If the system is not to be used for some time after installation, shut off the circuit breaker to eliminate unnecessary power consumption.
- If the circuit breaker trips to shut off the power to the air conditioner, the system will restore the original operation mode when the circuit breaker is turned on again.

2. Test items

| Test items | Symptom | Check |
|--|--|-------|
| Indoor and outdoor units are installed securely. | Fall, vibration, noise | |
| No refrigerant gas leaks. | Incomplete cooling/heating function | |
| Refrigerant gas and liquid pipes and indoor drain hose extension are thermally insulated. | Water leakage | |
| Draining line is properly installed. | Water leakage | |
| System is properly grounded. | Electrical leakage | |
| Only specified wires are used for all wiring, and all wires are connected correctly. | No operation or burn damage | |
| Indoor or outdoor unit's air inlet or air outlet are unobstructed. | Incomplete cooling/heating function | |
| Stop valves are opened. | Incomplete cooling/heating function | |
| Indoor unit properly receives remote control commands. | No operation | |
| Explain to the user that when using a smartphone for operation, it is necessary to prepare a repeater, or similar device, if the signal from the wireless LAN router is weak near the air conditioner. | Air conditioner not responding to smartphone | |

2. Outdoor Unit

2.1 2/3/4MXM, 2MXT, 2MXTH



Contents

| | | | |
|--|----------|--|-----------|
| Safety Considerations | 1 | 4. Refrigerant piping | 10 |
| Accessories | 3 | 5. Pressure test and evacuating system..... | 11 |
| Precautions for Selecting a Location | 3 | 6. Charging with refrigerant | 12 |
| Precautions on Installation | 4 | Wiring | 13 |
| Outdoor Unit Installation Diagram | 4 | Priority Room Setting | 16 |
| Installation Space Requirements | 5 | Night Quiet Mode setting | 17 |
| Selecting a Location for Installation of the Indoor Units | 6 | COOL/HEAT mode lock [X161A] | 17 |
| Connections (connection port) | 7 | When attaching the optional drain pan heater (excluding 2MXTH models) | 18 |
| How to Use Reducers | 8 | Pump Down Operation | 18 |
| Outdoor Unit Installation | 9 | Trial Operation and Testing | 19 |
| 1. Installing the outdoor unit | 9 | 1. Wiring error check | 19 |
| 2. Drain work | 9 | 2. Trial operation and testing | 20 |
| 3. Flaring the pipe end..... | 9 | 3. Test items | 20 |

The pictures in this document are for illustrative purposes only.

Safety Considerations

Refer also to the General Safety Considerations in the separate booklet.

| | |
|---|---|
|  | Read the precautions in this manual carefully before operating the unit. |
|  | This appliance is filled with R32. |

Read these **Safety Considerations for Installation** carefully before installing an air conditioner or heat pump. After completing the installation, make sure that the unit operates properly during the startup operation.

Instruct the user on how to operate and maintain the unit. Inform users that they should store this installation manual with the operation manual for future reference.

Always use a licensed installer or contractor to install this product. Improper installation can result in water or refrigerant leakage, electric shock, fire, or explosion.

Meanings of **DANGER**, **WARNING**, **CAUTION**, and **NOTE** Symbols:

⚠ DANGER Indicates an imminently hazardous situation which, if not avoided, will result in death or serious injury.

⚠ WARNING Indicates a potentially hazardous situation which, if not avoided, could result in death or serious injury.

⚠ CAUTION Indicates a potentially hazardous situation which, if not avoided, may result in minor or moderate injury. It may also be used to alert against unsafe practices.

⚠ NOTE Indicates situations that may result in equipment or property damage accidents only.

⚠ DANGER

- Refrigerant gas is heavier than air and replaces oxygen. A massive leak can lead to oxygen depletion, especially in basements, and an asphyxiation hazard could occur leading to serious injury or death.

- Do not ground units to water pipes, gas pipes, telephone wires, or lightning rods as incomplete grounding can cause a severe shock hazard resulting in severe injury or death. Additionally, grounding to gas pipes could cause a gas leak and potential explosion causing severe injury or death.
- If refrigerant gas leaks during installation, ventilate the area immediately. Refrigerant gas may produce toxic gas if it comes into contact with fire. Exposure to this gas could cause severe injury or death.
- After completing the installation work, check that the refrigerant gas does not leak throughout the system.
- Do not install unit in an area where flammable materials are present due to risk of explosions that can cause serious injury or death.
- Safely dispose all packing and transportation materials in accordance with federal/state/local laws or ordinances. Packing materials such as nails and other metal or wood parts, including plastic packing materials used for transportation may cause injury or death by suffocation.
- All possible ignition sources, including cigarette smoking, should be kept sufficiently far away from the site of installation, repairing, removing and disposal.

⚠ WARNING

- Only qualified personnel licensed or certified in their jurisdiction must carry out the installation work. Installation must be done in accordance with this installation manual. Improper installation may result in water leakage, electric shock, or fire.
- Pipe-work including piping material, pipe routing, and installation shall include protection from physical damage in operation and service, and be in compliance with national and local codes and standards, such as ASHRAE 15, ASHRAE 15.2, IAPMO Uniform Mechanical Code, ICC International Mechanical Code, or CSA B52. All field joints shall be accessible for inspection prior to being covered or enclosed.
- When installing the unit in a small room, take measures to keep the refrigerant concentration from exceeding allowable safety limits. Excessive refrigerant leaks, in the event of an accident in a closed ambient space, can lead to oxygen deficiency.

- Use only specified accessories and parts for installation work. Failure to use specified parts may result in water leakage, electric shock, fire, or the unit falling.
- Install the air conditioner or heat pump on a foundation strong enough that it can withstand the weight of the unit. A foundation of insufficient strength may result in the unit falling and causing injury.
- Take into account strong winds, typhoons, or earthquakes when installing. Improper installation may result in the unit falling and causing accidents.
- Make sure that a separate power supply circuit is provided for this unit and that all electrical work is carried out by qualified personnel licensed or certified in their jurisdiction according to local, state, and national regulations. An insufficient power supply capacity or improper electrical construction may lead to electric shock or fire.
- Make sure that all wiring is secured, that specified wires are used, and that no external forces act on the terminal connections or wires. Improper connections or installation may result in fire.
- When wiring, position the wires so that the service lid can be securely fastened. Improper positioning of the service lid may result in electric shock, fire, or the terminals overheating.
- Before touching electrical parts, turn off the unit.
- The circuit must be protected with safety devices in accordance with local and national codes, i.e. a circuit breaker.
- Securely fasten the outdoor unit service lid. If the service lid is not installed properly, dust or water may enter the outdoor unit causing fire or electric shock.
- When installing or relocating the system, keep the refrigerant circuit free from substances other than the specified refrigerant (R32) such as air. Any presence of air or other foreign substance in the refrigerant circuit can cause an abnormal pressure rise or rupture, which may result in equipment damage and even injury.
- Do not change the setting of the protection devices. If the pressure switch, thermal switch, or other protection device is shorted and operated forcibly, or parts other than those specified by Daikin are used, fire or explosion may occur.
- Do not use means to accelerate the defrosting process (if possible) or to clean, other than those recommended by the manufacturer.
- The appliance must be stored in a room without continuously operating ignition sources (for example: open flames, an operating gas appliance or an operating electric heater).
- Do not pierce or burn.
- Be aware that refrigerants may not contain an odor.
- Comply with national gas regulations.
- The indoor equipment and pipes shall be securely mounted and guarded such that accidental rupture of equipment cannot occur from such events as moving furniture or reconstruction activities.
- Be careful when transporting the product.
- Do not turn off the power immediately after stopping operation. Always wait for at least 5 minutes before turning off the power. Otherwise, water leakage may occur.
- Do not use a charging cylinder. Using a charging cylinder may cause the refrigerant to deteriorate.
- Refrigerant R32 in the system must be kept clean, dry, and tight.
 - (a) Clean and Dry -- Foreign materials (including mineral oils such as SUNISO oil or moisture) should be prevented from getting into the system.
 - (b) Tight -- R32 does not contain any chlorine, does not destroy the ozone layer, and does not reduce the earth's protection against harmful ultraviolet radiation. R32 can contribute to the greenhouse effect if it is released. Therefore take proper measures to check for the tightness of the refrigerant piping installation. Read the chapter *Refrigerant Piping* and follow the procedures.
- The outdoor unit is for R32. See the catalog for indoor models that can be connected. Normal operation is not possible when connected to non-compatible indoor units.
- Remote controller (wireless kit) transmitting distance can be shorter than expected in rooms with electronic fluorescent lamps (inverter or rapid start types). Install the indoor unit far away from fluorescent lamps as much as possible.
- Indoor units are for indoor installation only. Outdoor units can be installed either outdoors or indoors.
- Do not install the air conditioner or heat pump in the following locations:
 - (a) Where a mineral oil mist or oil spray or vapor is produced, for example, in a kitchen. Plastic parts may deteriorate and fall off or result in water leakage.
 - (b) Where corrosive gas, such as sulfurous acid gas, is produced. Corroding copper pipes or soldered parts may result in refrigerant leakage.
 - (c) Near machinery emitting electromagnetic waves. Electromagnetic waves may disturb the operation of the control system and cause the unit to malfunction.
 - (d) Where flammable gas may leak, where there is carbon fiber, or ignitable dust suspension in the air, or where volatile flammables such as thinner or gasoline are handled. Operating the unit in such conditions can cause a fire.
- Take adequate measures to prevent the outdoor unit from being used as a shelter by small animals. Small animals making contact with electrical parts can cause malfunctions, smoke, or fire. Instruct the user to keep the area around the unit clean.
- Servicing shall be performed only as recommended by the manufacturer and licensed or certified in their jurisdiction.

CAUTION





- Do not touch the switch with wet fingers. Touching a switch with wet fingers can cause electric shock.
- Do not allow children to play on or around the unit to prevent injury.
- Wear adequate personal protective equipment (protective gloves, safety glasses,...) when installing, maintaining or servicing the system.
- The heat exchanger fins are sharp enough to cut. To avoid injury, wear gloves or cover the fins while working around them.
- Do not touch the refrigerant pipes during and immediately after operation as the refrigerant pipes may be hot or cold, depending on the condition of the refrigerant flowing through the refrigerant piping, compressor, and other refrigerant cycle parts. Your hands may suffer burns or frostbite if you touch the refrigerant pipes. To avoid injury, give the pipes time to return to normal temperature or, if you must touch them, be sure to wear proper gloves.
- Install drain piping to ensure proper drainage. Improper drain piping may result in water leakage and property damage.
- Insulate piping to prevent condensation.

NOTE

- The outdoor unit should be positioned where the unit and power supply wires (breaker panel to outdoor unit) are at least 10ft (3m) away from any televisions or radios. (The unit may cause interference with the picture or sound.) Depending on the radio waves, a distance of 10ft (3m) may not be sufficient to eliminate the noise.
- Dismantling the unit, treatment of the refrigerant, oil and additional parts must be done in accordance with the relevant local, state, and national regulations.
- Only use tools for R32 or R410A, such as a gauge manifold, charge hose, gas leak detector, reverse flow check valve, refrigerant charge base, vacuum gauge, or refrigerant recovery equipment.
- If the conventional refrigerant and refrigerator oil are mixed in R32, the refrigerant may deteriorate.
- As maximum allowable pressure is 604psi (4.17MPa), the wall thickness of field-installed pipes should be selected in accordance with the relevant local, state, and national regulations.

RN007(R32)-U

Accessories

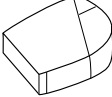
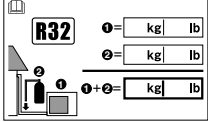
| | | | |
|--|---|--|---|
| (A) Installation manual  | 1 | (B) Drain socket  This is at the bottom of the packaging. | 1 |
| (C) Drain cap (1)  | 6 | (D) Drain cap (2)  | 3 |
| (E) Reducer assy  | 1 | (F) Warranty | 1 |
| (G) Refrigerant charge label  Affix near the machine nameplate. | 1 | (H) General Safety Considerations | 1 |

Precautions for Selecting a Location

- 1) Choose a place solid enough to bear the weight and vibration of the unit, where the operating sound will not be amplified.
- 2) Choose a location where the air discharged from the unit or the operating sound will not cause a nuisance to the neighbors of the user.
- 3) Avoid locations, such as near bedrooms, where the operating sound may cause disturbance.
- 4) There must be sufficient space to carry the unit into and out of the site.
- 5) There must be sufficient space for air passage and no obstructions around the air inlet and the air outlet.
- 6) In coastal areas or other places with salty atmosphere or one containing sulfate gas, corrosion may shorten the life of the air conditioner.
- 7) Since water will flow from the drain of the outdoor unit, do not place anything under the unit which must be kept away from moisture.
- 8) A location where flammable gas does not leak. Position at least 6-5/8ft (2m) from propane gas cylinders.

NOTE

Cannot be installed suspended from a ceiling or stacked.

CAUTION

When operating the air conditioner in a low outdoor ambient temperature, be sure to follow the instructions described below.

- To prevent exposure to wind, install the outdoor unit with its suction side facing the wall.
- Never install the outdoor unit at a site where the suction side may be exposed directly to wind.
- To prevent exposure to wind, it is recommended to install a baffle plate on the air discharge side of the outdoor unit.
- In heavy snow areas, select an installation site where the snow will not affect the unit.
- If there is a likelihood of snow accumulating on the outdoor unit, attach a snow protection hood.
- In high humidity areas or heavy snow areas, it is recommended to attach a drain pan heater to prevent ice build-up from the bottom frame.

- Construct a large canopy.
- Construct a pedestal.

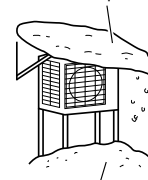

Install the unit high enough off the ground to prevent burying in snow.

Precautions on Installation

- Check the strength and level of the installation surface so that the unit does not cause any operating vibrations or noise after installation.
- Fix the unit in place securely using foundation bolts, as in the figure. (Prepare 4 sets of 5/16 inch (M8) or 3/8 inch (M10) foundation bolts, nuts and washers; all sold separately.)
- It is best to screw in the foundation bolts until their ends are 3/4 inch (20mm) from the foundation surface.

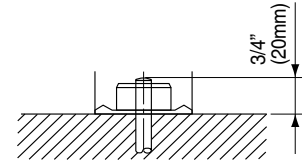

Outdoor Unit Installation Diagram

CAUTION

- Do not connect the embedded branch piping and the outdoor unit when only carrying out piping work without connecting the indoor unit in order to add another indoor unit later. Make sure no dirt or moisture gets into either side of the embedded branch piping. Refer to "4. Refrigerant piping" on page 10 for details.
- It is not possible to have only 1 indoor unit connected. **Be sure to connect at least 2 indoor units.**

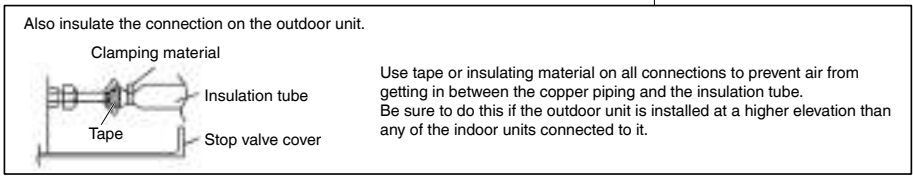
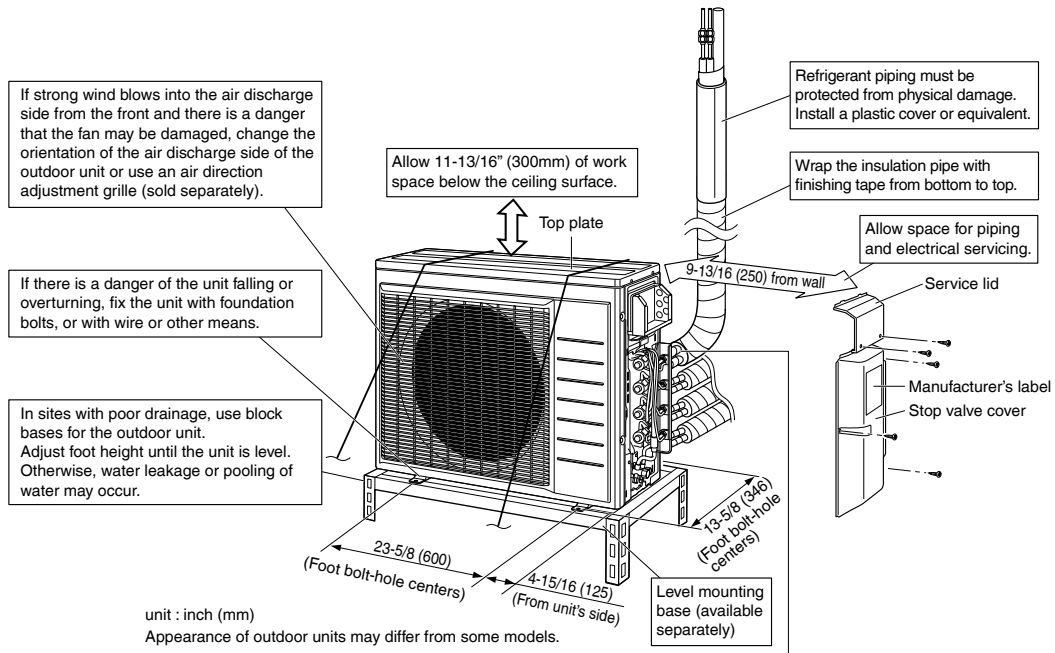

Refrigerant charge label

Please fill in with indelible ink.

- ① the factory refrigerant charge of the product,
- ② the additional refrigerant amount charged in the field and
- ① + ② the total refrigerant charge on the refrigerant charge label supplied with the product.

Affix the refrigerant charge label near the manufacturer's label after filling it out.

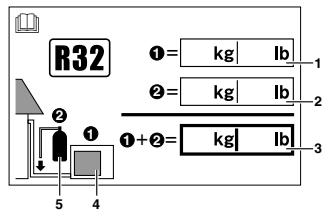

- 1 factory refrigerant charge of the product: see unit manufacturer's label
- 2 additional refrigerant amount charged in the field
- 3 total refrigerant charge
- 4 outdoor unit
- 5 refrigerant cylinder and manifold for charging

Installation Space Requirements

- Position the unit on a horizontal surface. Any tilt in the unit should be 3° or less to the horizontal.
- Where a wall or other obstacle is in the path of the outdoor unit's intake or exhaust airflow, follow the installation space requirements below.
- For any of the below installation patterns, the wall height on the outlet side should be 47-1/4 inch (1200mm) or less.
- Secure as much installation space around the unit as the location allows, as more space will result in more efficient operation.

Wall facing one side

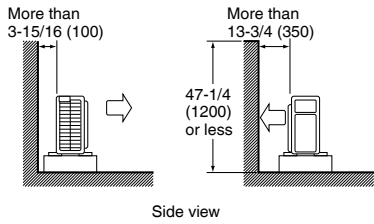

Walls facing two sides

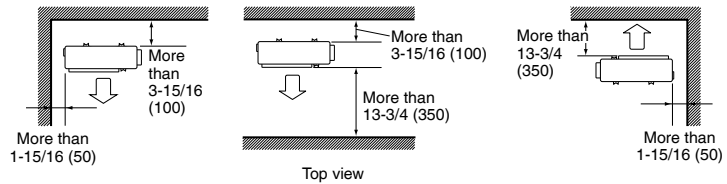

Walls facing three sides

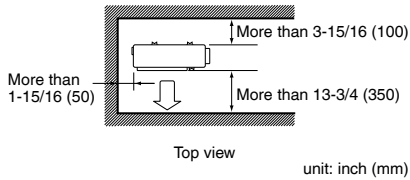

When installed as in the figure on the left, it is recommended to either change the orientation of the outdoor unit outlet side or use the air direction adjustment grille (sold separately).

Selecting a Location for Installation of the Indoor Units

- Minimum required floor area (A_{min})

The minimum required floor area of the room where the indoor unit is installed varies depending on the installation height and refrigerant amount.

| Refrigerant amount (kg) | Indoor unit installation height (m) | | | | | |
|-------------------------|-------------------------------------|------|------|------|------|------|
| | 0.6 | 1.8 | 2.0 | 2.2 | 2.4 | 2.6 |
| < 1.84 | No restriction | | | | | |
| 1.9 | 31.0 | 6.9 | 6.2 | 5.6 | 5.2 | 4.8 |
| 2.0 | 34.3 | 7.3 | 6.5 | 5.9 | 5.4 | 5.0 |
| 2.1 | 37.8 | 7.6 | 6.9 | 6.2 | 5.7 | 5.3 |
| 2.2 | 41.5 | 8.0 | 7.2 | 6.5 | 6.0 | 5.5 |
| 2.3 | 45.4 | 8.4 | 7.5 | 6.8 | 6.3 | 5.8 |
| 2.4 | 49.4 | 8.7 | 7.8 | 7.1 | 6.5 | 6.0 |
| 2.5 | 53.6 | 9.1 | 8.2 | 7.4 | 6.8 | 6.3 |
| 2.6 | 58.0 | 9.4 | 8.5 | 7.7 | 7.1 | 6.5 |
| 2.7 | 62.6 | 9.8 | 8.8 | 8.0 | 7.4 | 6.8 |
| 2.8 | 67.3 | 10.2 | 9.2 | 8.3 | 7.6 | 7.0 |
| 2.9 | 72.2 | 10.5 | 9.5 | 8.6 | 7.9 | 7.3 |
| 3.0 | 77.2 | 10.9 | 9.8 | 8.9 | 8.2 | 7.5 |
| 3.1 | 82.5 | 11.3 | 10.1 | 9.2 | 8.4 | 7.8 |
| 3.2 | 87.9 | 11.6 | 10.5 | 9.5 | 8.7 | 8.0 |
| 3.3 | 93.4 | 12.0 | 10.8 | 9.8 | 9.0 | 8.3 |
| 3.4 | 99.2 | 12.3 | 11.1 | 10.1 | 9.3 | 8.5 |
| 3.5 | 105.1 | 12.7 | 11.4 | 10.4 | 9.5 | 8.8 |
| 3.6 | 111.2 | 13.1 | 11.8 | 10.7 | 9.8 | 9.0 |
| 3.7 | 117.5 | 13.4 | 12.1 | 11.0 | 10.1 | 9.3 |
| 3.8 | 123.9 | 13.8 | 12.4 | 11.3 | 10.3 | 9.6 |
| 3.9 | 130.5 | 14.5 | 12.7 | 11.6 | 10.6 | 9.8 |
| 4.0 | 137.3 | 15.3 | 13.1 | 11.9 | 10.9 | 10.1 |
| 4.1 | 144.2 | 16.0 | 13.4 | 12.2 | 11.2 | 10.3 |
| 4.2 | 151.4 | 16.8 | 13.7 | 12.5 | 11.4 | 10.6 |
| 4.3 | 158.7 | 17.6 | 14.3 | 12.8 | 11.7 | 10.8 |
| 4.4 | 166.1 | 18.5 | 15.0 | 13.1 | 12.0 | 11.1 |

| Refrigerant amount (lb) | Indoor unit installation height (ft) | | | | | |
|-------------------------|--------------------------------------|-----|-----|-----|-----|-----|
| | 2.0 | 5.9 | 6.6 | 7.2 | 7.9 | 8.5 |
| < 4.05 | No restriction | | | | | |
| 4.2 | 333 | 74 | 67 | 61 | 56 | 51 |
| 4.4 | 369 | 78 | 70 | 64 | 59 | 54 |
| 4.6 | 407 | 82 | 74 | 67 | 62 | 57 |
| 4.9 | 447 | 86 | 77 | 70 | 64 | 60 |
| 5.1 | 489 | 90 | 81 | 74 | 67 | 62 |
| 5.3 | 532 | 94 | 84 | 77 | 70 | 65 |
| 5.5 | 577 | 98 | 88 | 80 | 73 | 68 |
| 5.7 | 624 | 102 | 91 | 83 | 76 | 70 |
| 6.0 | 673 | 106 | 95 | 86 | 79 | 73 |
| 6.2 | 724 | 109 | 98 | 90 | 82 | 76 |
| 6.4 | 777 | 113 | 102 | 93 | 85 | 78 |
| 6.6 | 831 | 117 | 106 | 96 | 88 | 81 |
| 6.8 | 888 | 121 | 109 | 99 | 91 | 84 |
| 7.1 | 946 | 125 | 113 | 102 | 94 | 87 |
| 7.3 | 1006 | 129 | 116 | 106 | 97 | 89 |
| 7.5 | 1068 | 133 | 120 | 109 | 100 | 92 |
| 7.7 | 1131 | 137 | 123 | 112 | 103 | 95 |
| 7.9 | 1197 | 141 | 127 | 115 | 106 | 97 |
| 8.2 | 1264 | 145 | 130 | 118 | 108 | 100 |
| 8.4 | 1334 | 149 | 134 | 122 | 111 | 103 |
| 8.6 | 1405 | 156 | 137 | 125 | 114 | 106 |
| 8.8 | 1478 | 164 | 141 | 128 | 117 | 108 |
| 9.0 | 1553 | 173 | 144 | 131 | 120 | 111 |
| 9.3 | 1629 | 181 | 148 | 134 | 123 | 114 |
| 9.5 | 1708 | 190 | 154 | 138 | 126 | 116 |
| 9.7 | 1788 | 199 | 161 | 141 | 129 | 119 |

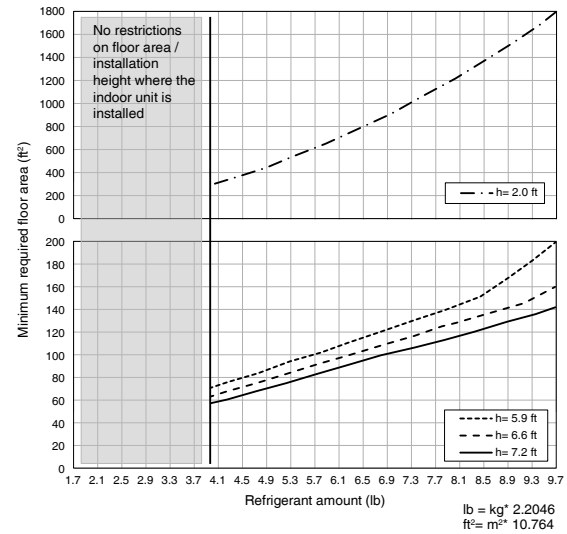
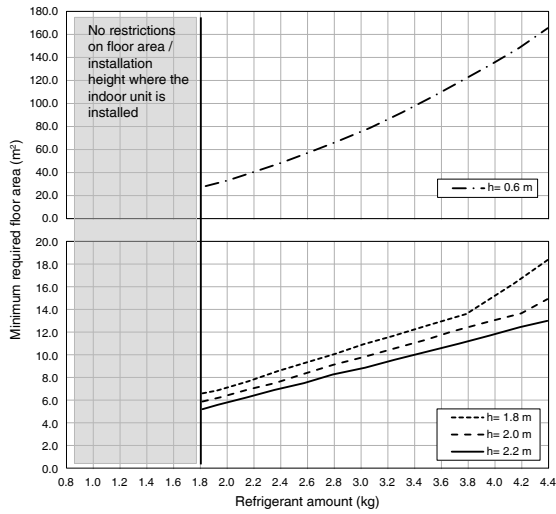

lb = kg * 2.2046
ft² = m² * 10.764

Selecting a Location for Installation of the Indoor Units

- The maximum allowable length of refrigerant piping, and the maximum allowable height difference between the outdoor and indoor units, are listed below.
- Refrigerant piping must be kept to a minimum.
The suggested shortest pipe length per room is 10ft (3m), in order to avoid noise from the outdoor unit and vibration.
(Mechanical noise and vibration may occur depending on how the unit is installed and the environment in which it is used.)

| | | |
|--|--------------------------------|------------------|
| Outdoor unit capacity class | 2MXM*, 2MXT* | 3MXM*, 4MXM* |
| Piping to each indoor unit | 82ft (25m) max. 10ft (3m) min. | |
| Total length of piping between all units | 164ft (50m) max. | 230ft (70m) max. |

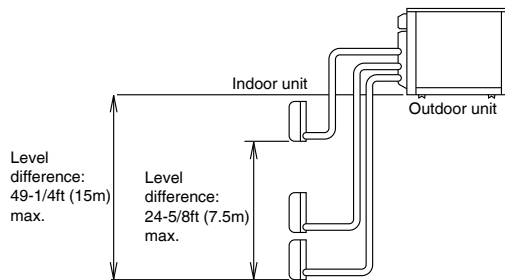

If the outdoor unit is positioned higher than the indoor units.

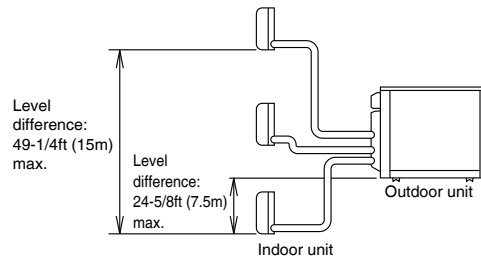

If the outdoor unit is positioned lower than one or more indoor units.

Connections (connection port)

Install the indoor unit according to the table below, which shows the relationship between the class of indoor unit and the corresponding port.

The total indoor unit class that can be connected to this unit:

- 2MXM*, 2MXT* – Up to 24000 Btu/h
- 3MXM* – Up to 39000 Btu/h
- 4MXM* – Up to 48000 Btu/h

The line set piping size is determined by the size of the indoor unit fittings.

Reducers are used at the outdoor unit to accommodate the correct gas line pipe size.

| Port | 2MXM*, 2MXT* | 3MXM* | 4MXM* |
|------|----------------------------|--------------------------------|--|
| A | 07, 09, 12 | 07, 09, 12 | 07, 09, 12 |
| B | # (07), # (09), # (12), 15 | # (07), # (09), # (12), 15, 18 | # (07), # (09), # (12), 15, 18 |
| C | — | # (07), # (09), # (12), 15, 18 | # (07), # (09), # (12), 15, 18 |
| D | — | — | △ (07), △ (09), △ (12), □ (15), □ (18), 24 |

- : Use a reducer to connect pipes.
- : Use No. 1 and 3 reducers.
- # : Use No. 2 and 4 reducers.
- △ : Use No. 5 and 6 reducers.

Refer to “How to Use Reducers” on page 8 for information on reducer numbers and their shapes.

How to Use Reducers

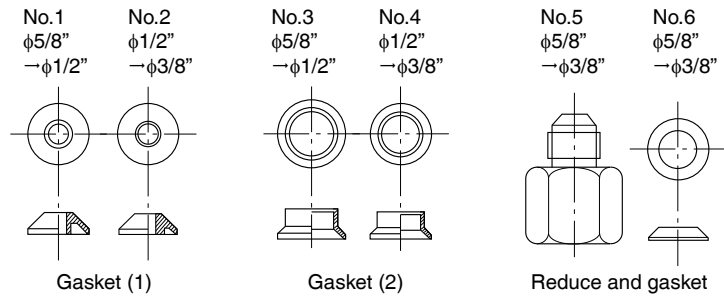

• Use the reducers supplied with the unit as described below.

(1) Connecting a pipe of $\phi 1/2$ inch (12.7mm) to a gas pipe connection port for $\phi 5/8$ inch (15.9mm) :

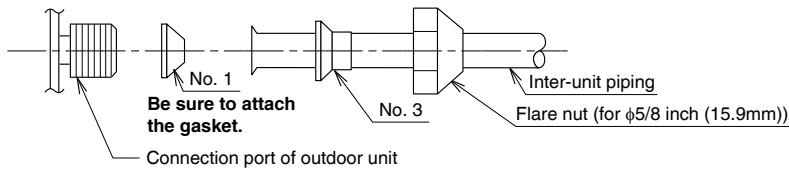

(2) Connecting a pipe of $\phi 3/8$ inch (9.5mm) to a gas pipe connection port for $\phi 1/2$ inch (12.7mm) :

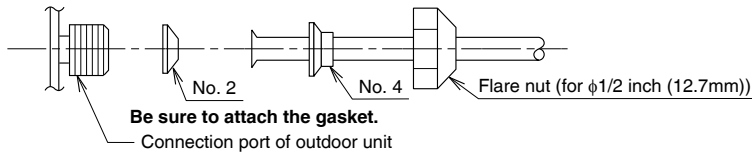

(3) Connecting a pipe of $\phi 3/8$ inch (9.5mm) to a gas pipe connection port for $\phi 5/8$ inch (15.9mm) :

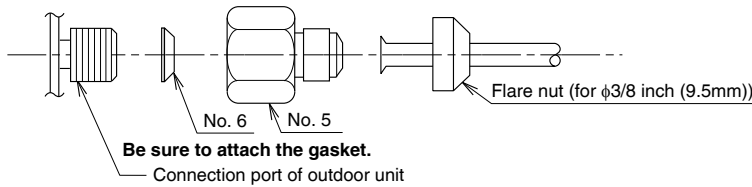

- When using the reducer packing shown above, be careful not to overtighten the nut, or the smaller pipe may become damaged. (Apply about 2/3 to 3/3 the normal torque.)
- Apply a coat of refrigeration oil to the threaded connection port of the outdoor unit where the flare nut comes in.
- Use an appropriate wrench to avoid damaging the connection thread by overtightening the flare nut.

| Flare nut tightening torque | |
|-----------------------------|--|
| $\phi 3/8$ inch (9.5mm) | 24-1/8 – 29-1/2lbf • ft (32.7-39.9N • m) |
| $\phi 1/2$ inch (12.7mm) | 36-1/2 – 44-1/2lbf • ft (49.5-60.3N • m) |
| $\phi 5/8$ inch (15.9mm) | 45-5/8 – 55-5/8lbf • ft (61.8-75.4N • m) |

Outdoor Unit Installation

1. Installing the outdoor unit

- 1) When installing the outdoor unit, refer to “Precautions for Selecting a Location” on page 3 and the “Outdoor Unit Installation Diagram” on page 4.
- 2) If drain work is necessary, follow the procedures below.

2. Drain work

CAUTION
 In cold areas, do not use a drain socket, drain caps (1, 2) and a drain hose with the outdoor unit. (Drain water may freeze, impairing heating performance.)

- If the drain port is covered by a mounting base or floor surface, place additional foot bases of at least 1-1/4 inch (30mm) in height under the outdoor unit's feet.
- 1) Attach ③ drain cap (1) and ④ drain cap (2).
 - 2) Attach ⑤ drain socket to the shape of drain hole and fix it by turning.
 - When attaching ⑤ drain socket to the bottom frame, make sure to connect the drain hose to the drain socket first.

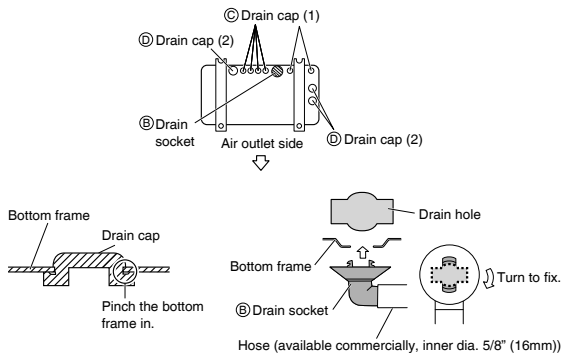

3. Flaring the pipe end

- WARNING**
- Do not apply mineral oil to the flare.
 - Prevent mineral oil from getting into the system as this would reduce the service life of the units.
 - Never use piping which has been used for previous installations. Only use parts which are delivered with this unit.
 - Never install a dryer to this R32 unit in order to guarantee its service life.
 - The drying material may dissolve and damage the system.
 - Improper flaring may result in refrigerant gas leakage.

CAUTION
 Do not reuse joints which have been used once already.

- 1) Cut the pipe end with a pipe cutter.
- 2) Remove burrs with the cut surface facing downward, so that the filings do not enter the pipe.
- 3) Put the flare nut on the pipe.
- 4) Flare the pipe.
- 5) Check that the flaring has been done correctly.

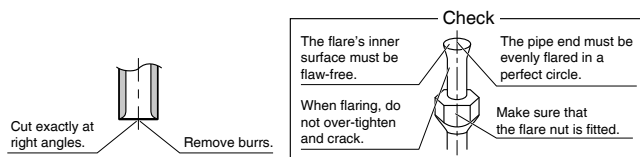

Set exactly at the position shown below.

| Flare tool for R32 or R410A | Conventional flare tool | |
|-----------------------------|-------------------------|---|
| | Clutch-type | Clutch-type (Rigid-type) Wing-nut type (Imperial-type) |
| A | 0-0.020 inch (0-0.5mm) | 0.039-0.059 inch (1.0-1.5mm) 0.059-0.079 inch (1.5-2.0mm) |

4. Refrigerant piping

⚠ CAUTION

- Use the flare nut fixed to the main unit. (This is to prevent the flare nut from cracking as a result of deterioration over time.)
 - To prevent gas leakage, apply refrigeration oil only to the inner surface of the flare. (Use refrigeration oil for R32 or R410A.)
 - Use a torque wrench when tightening the flare nuts to prevent damage to the flare nuts and gas leakage.
-
- Align the centers of both flares and tighten the flare nuts 3 or 4 turns by hand, then tighten them fully with a spanner and a torque wrench.

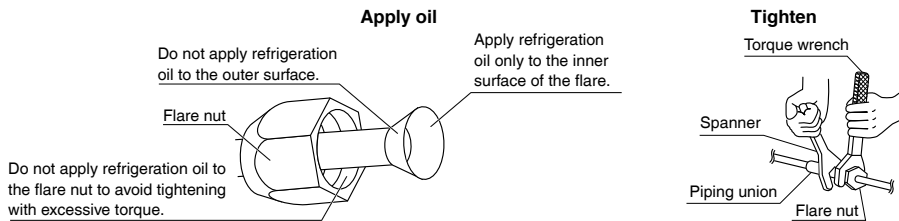

Tightening torque

Piping connection

| Flare nut | | | |
|--|--|--|--|
| Gas side | | Liquid side | |
| 3/8 inch (9.5mm) | 1/2 inch (12.7mm) | 5/8 inch (15.9mm) | 1/4 inch (6.4mm) |
| 24-1/8 – 29-1/2lb • ft (32.7-39.9N • m) | 36-1/2 – 44-1/2lb • ft (49.5-60.3N • m) | 45-5/8 – 55-5/8lb • ft (61.8-75.4N • m) | 10-1/2 – 12-3/4lb • ft (14.2-17.2N • m) |

Valve cap

| Width across flats | |
|--|--|
| 3/4 inch (19mm) | 7/8 inch (22mm) |
| 12-5/8 – 15-3/8lb • ft (17.0-20.9N • m) | 16 – 20-1/4lb • ft (21.6-27.4N • m) |

Service port cap

| |
|---------------------------------------|
| 8 – 10-7/8lb • ft (10.7-14.7N • m) |
|---------------------------------------|

Cautions on pipe handling

- Protect the open end of the pipe from dust and moisture.
- All pipe bends should be as gentle as possible. Use a pipe bender for bending.

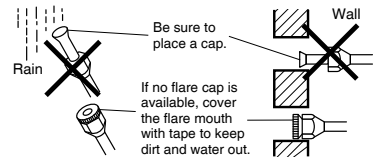

Selection of copper and heat insulation materials

When using commercial copper pipes and fittings, observe the following:

- Insulation material: Polyethylene foam
Heat transfer rate: 0.041 to 0.052W/mK (0.024 to 0.030Btu/ft•°F) (0.035 to 0.045kcal/mh•°C)
Be sure to use insulation that is designed for use with HVAC Systems.
- ACR Copper only.
- Be sure to insulate both the gas and liquid piping and observe the insulation dimensions as below.

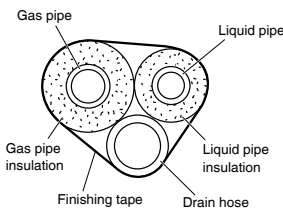

| | Piping size | Minimum bend radius | Piping thickness | Thermal insulation size | Thermal insulation thickness |
|-------------|------------------------|-----------------------------|-------------------------------|---------------------------------|------------------------------|
| Gas side | O.D. 3/8 inch (9.5mm) | 1-3/16 inch (30mm) or more | 0.031 inch (0.8mm) (C1220T-O) | I.D. 15/32-19/32 inch (12-15mm) | 13/32 inch (10mm) Min. |
| | O.D. 1/2 inch (12.7mm) | 1-9/16 inch (40mm) or more | | I.D. 9/16-5/8 inch (14-16mm) | |
| | O.D. 5/8 inch (15.9mm) | 1-15/16 inch (50mm) or more | 0.039 inch (1.0mm) (C1220T-O) | I.D. 5/8-13/16 inch (16-20mm) | |
| Liquid side | O.D. 1/4 inch (6.4mm) | 1-3/16 inch (30mm) or more | 0.031 inch (0.8mm) (C1220T-O) | I.D. 5/16-13/32 inch (8-10mm) | |

- Use separate thermal insulation pipes for gas and liquid refrigerant pipes.
- Using finishing tape, bundle and wrap the indoor unit piping and drain hose together so that the drain hose is below the other piping.

Outdoor Unit Installation

5. Pressure test and evacuating system

⚠ WARNING

- Make sure that air or any matter other than refrigerant (R32) does not get into the refrigeration cycle.
- If refrigerant gas leaks should occur, ventilate the room as soon and as much as possible.
- R32, as well as other refrigerants, should always be recovered and never be released directly into the environment.
- **Use tools for R32 or R410A (such as the gauge manifold, charging hose, or vacuum pump adapter).**

⚠ CAUTION

It is highly recommended that you do not open/close the stop valves when the outdoor temperature is below -5°F (-21°C) as this may result in refrigerant leakage.

- When piping work is complete, it is necessary to perform a pressure test and evacuate system with a vacuum pump.
- If using additional refrigerant, purge the air from the refrigerant pipes and indoor unit using a vacuum pump, then charge additional refrigerant.
- Use a hexagonal wrench (3/16 inch (4mm)) to operate the stop valve rod.
- All refrigerant pipe joints should be tightened with a torque wrench to the specified tightening torque.

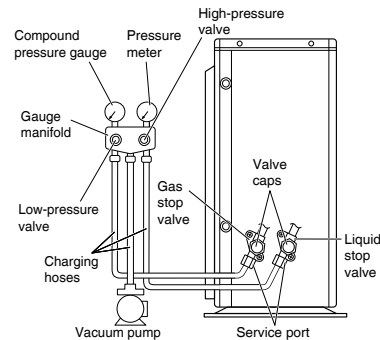

- 1) Pressurize the liquid pipe and gas pipe from the service ports of each stop valve to 604psi (4.17MPa) (do not pressurize more than 604psi (4.17MPa)) for 1 hour minimum, 24 hours recommended. If there is a pressure drop, check for leaks, make repairs and perform the pressure test again.
- 2) Connect the gauge manifold's charging hoses to the service ports of each stop valve.
- 3) Fully open the low-pressure valve (Lo) and the high-pressure valve (Hi) on the gauge manifold.
- 4) Evacuate system using vacuum pump to below 500 microns for 1 hour minimum.
- 5) Close the low-pressure valve (Lo) and the high-pressure valve (Hi) on the gauge manifold and stop vacuum pump. (Maintain this condition for 4-5 minutes to make sure that the compound pressure gauge pointer does not swing back.)*1
- 6) Remove the valve caps from the liquid stop valve and gas stop valve.
- 7) To open the liquid stop valve, turn the rod of the valve 90° counter-clockwise using a hexagonal wrench. Close it after 5 seconds, and check for gas leakage. Using soapy water, check for gas leakage from the indoor unit's flare and outdoor unit's flare and valve rods. After the check is complete, wipe all soapy water off *2.
- 8) Disconnect the charging hoses from the service ports, then fully open the liquid and gas stop valves. (Do not attempt to turn the valve rods further than they can go.)
- 9) Tighten the valve caps and service port caps for the liquid and gas stop valves with a torque wrench to the specified torques. Refer to "4. Refrigerant piping" on page 10 for details.

*1 If the compound pressure gauge pointer swings back, the refrigerant may have water content or there may be a loose pipe joint.

Check all pipe joints and retighten nuts as needed, then repeat steps 3) through 5).

*2 **Under no circumstances shall potential sources of ignition be used in the searching for or detection of refrigerant leaks.**

A halide torch (or any other detector using a naked flame) shall not be used.

Do not use substances containing chlorine and electronic leak detection for gas leak detection.

6. Charging with refrigerant



CAUTION

Even though the stop valve is fully closed, the refrigerant may slowly leak out; do not leave the flare nut removed for a long period of time.

- If the total length of piping for all rooms exceeds the table listed below, additionally charge with 0.22oz/ft (20g/m) of refrigerant (R32) for each additional piping length.
Be sure to add the proper amount of additional refrigerant.
Failure to do so may result in reduced performance.

| | | |
|--------------------------------------|----------------|-----------------|
| Outdoor unit capacity class | 2MXM*, 2MXT* | 3MXM*, 4MXM* |
| Total length of piping for all rooms | 98-3/8ft (30m) | 131-1/4ft (40m) |

Wiring

⚠ WARNING

- **RISK OF ELECTRIC SHOCK CAUSE INJURY OR DEATH.**
System contains oversize protective earthing (grounding) terminal which shall be properly connected.
- Do not ground units to water pipes, gas pipes, telephone wires, or lightning rods as incomplete grounding can cause a severe shock hazard resulting in severe injury or death.
Additionally, grounding to gas pipes could cause a gas leak and potential explosion causing severe injury or death.
- Do not use tapped wires, extension cords, or starburst connections, as they may cause overheating, electric shock, or fire.
- Do not use locally purchased electrical parts inside the product. (Do not branch the power for the drain pump, etc., from the terminal block.) Doing so may cause electric shock or fire.
- The circuit must be protected with safety devices in accordance with local and national codes, i.e. a circuit breaker.
- Use an all-pole disconnection type circuit breaker with at least 1/8 inch (3mm) between the contact point gaps.
- When carrying out wiring, take care not to pull at the conduit.
- Do not connect the power wire to the indoor unit. Doing so may cause electric shock or fire.
- Do not turn on the circuit breaker until all work is completed.

⚠ CAUTION

Precautions to be taken for power supply wiring

Recommend stranded cable for interunit wiring. Local code always supersedes recommendation.

- For stranded wires, make sure to use the round crimp-style terminal for connection to the power supply terminal block. Place the round crimp-style terminals on the wires up to the covered part and secure in place.

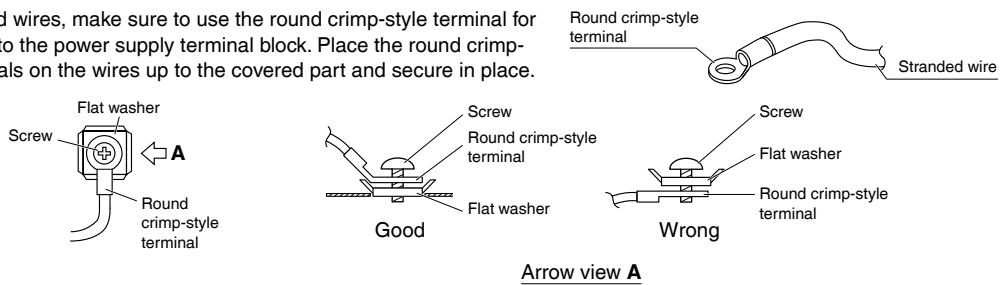

- If solid core wire must be used, be sure to curl the end of the lead. Improper work may cause heat and fire.

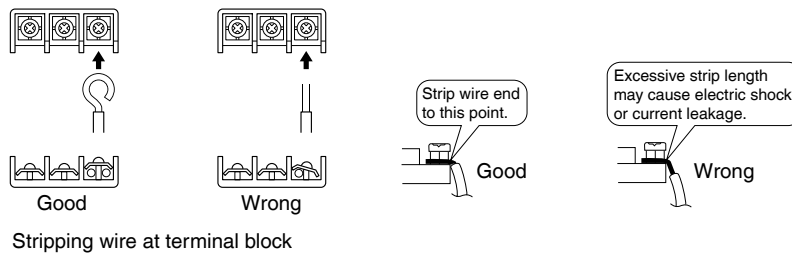

[Method of Mounting Conduit]

- When wiring, remove the top plate and look at the wiring diagram on the back of the top plate.
 - When connecting indoor units for 3 rooms or more, open knockout holes without deforming the conduit mounting plate.
- 1) Dismount the service lid by removing the 2 screws.
 - 2) Slide the protection plate up and remove it.
 - 3) Pass wires through the conduit and secure them with a lock nut.

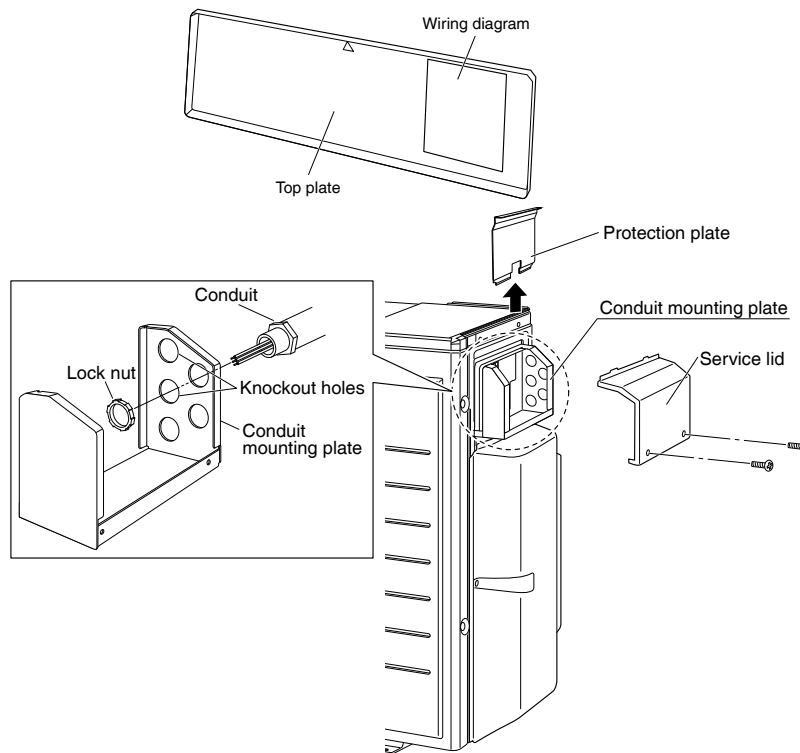

Wiring

[Wiring procedure]

- 1) Strip the insulation from the wire (3/4inch (20mm)).
- 2) Connect the inter-unit wires between the indoor and outdoor units **so that the terminal numbers match**. Tighten the terminal screws securely. It is recommended that a slot-head screwdriver be used to tighten the screws.
- 3) **Be sure to match the symbols for wiring and piping.**
- 4) Pull the wire lightly to make sure that it does not disconnect.
- 5) Pass the wiring through the cutout on the bottom of the protection plate and attach the protection plate.
- 6) After completing the work, reattach the service lid to its original position.

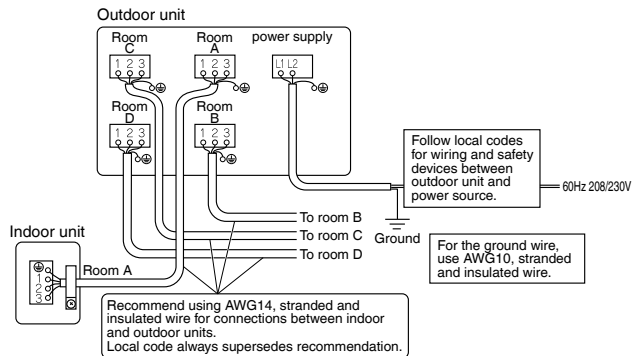

Note

Take care to ensure that all wiring between indoor unit and outdoor unit has a consistent connection. Any splices can cause communication errors.

• **2MXM, 2MXT models**

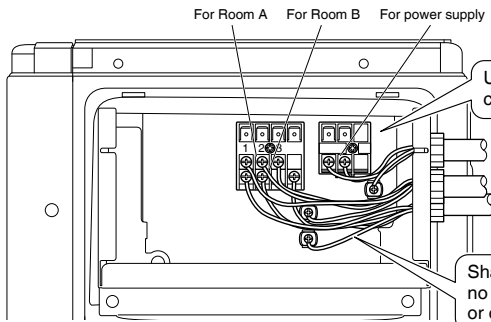

• **3MXM models**

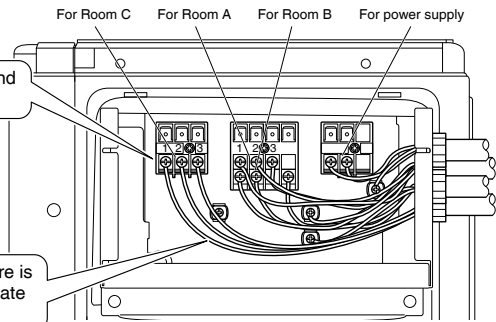

• **4MXM models**

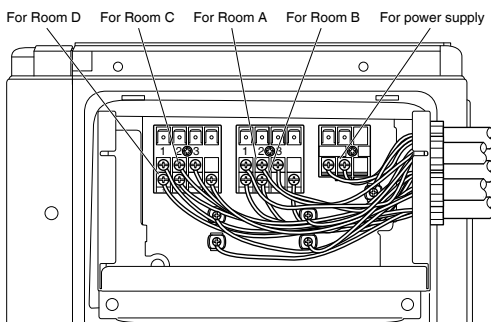

Ground

This air conditioner must be grounded. For grounding, follow all local, and state electrical codes.

Priority Room Setting

- To use priority room setting, initial settings must be made when the unit is installed. Explain the priority room setting, as described below, to the user, and confirm whether or not the user wants to use priority room setting. Setting it in the guest and living rooms is convenient.

About the priority room setting function

The indoor unit for which priority room setting is applied takes priority in the following cases.

1) Operation mode priority

The operation mode of the indoor unit which is set for priority room setting takes priority. If the set indoor unit is operating, all other indoor units do not operate and enter standby mode, according to the operation mode of the set indoor unit.

2) Priority during powerful operation

If the indoor unit which is set for priority room setting is operating at powerful, the capabilities of other indoor units will be somewhat reduced. Power supply gives priority to the indoor unit which is set for priority room setting.

3) Quiet operation priority

Setting the indoor unit to quiet operation will make the outdoor unit run quietly.

Setting procedure

Slide the priority room setting switch (SW4) to the on side for the switch that corresponds to the piping connected to the indoor unit to be set.

(In the figure below, it is room A.)

Once the settings are complete, switch the power on.

Be sure to set only one room

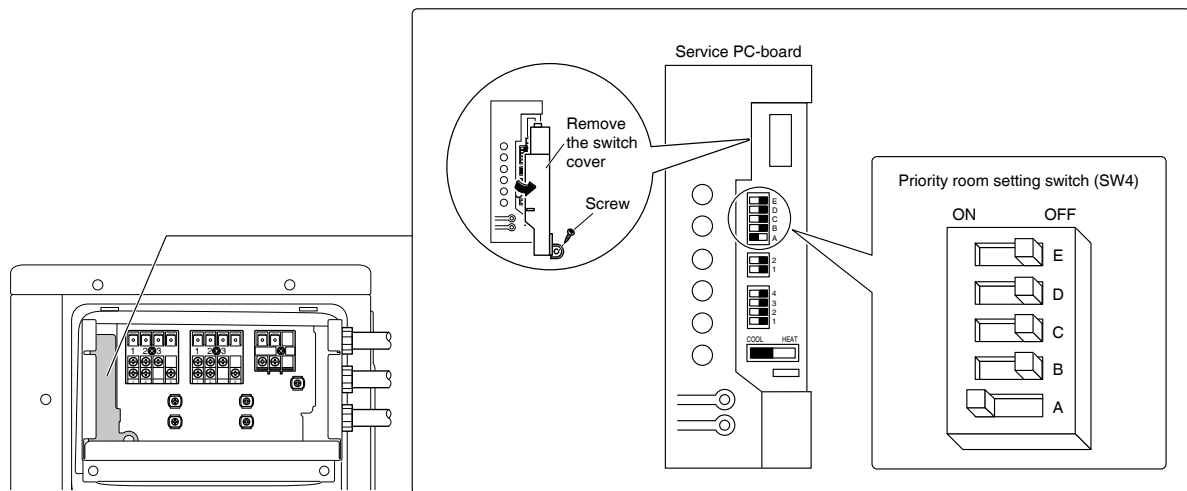

Night Quiet Mode setting

- If night quiet mode is to be used, initial settings must be made when the unit is installed. Explain night quiet mode, as described below, to the user, and confirm whether or not the user wants to use night quiet mode.

About night quiet mode

The night quiet mode function reduces operating noise of the outdoor unit at nighttime. This function is useful if the user is worried about the effects of the operating noise on the neighbors. However, cooling capacity will be reduced when operating in night quiet mode.

Setting procedure

Turn the night quiet mode switch (SW6-1) to on.

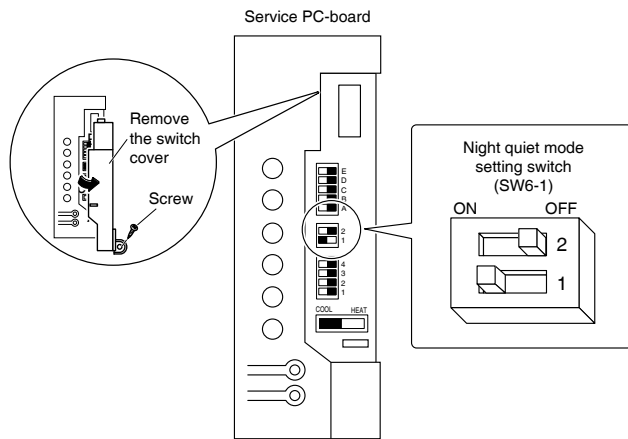

COOL/HEAT mode lock [X161A]

- Use the X161A connector to set the unit to only cool or heat.
 Setting to only heat (H) : short-circuit pins 1 and 3 of the connector [X161A]
 Setting to only cool (C) : short-circuit pins 3 and 5 of the connector [X161A]
 The following specifications apply to the connector housing and pins.

JST products Housing: VHR-5N
 Pin: SVH-21T-P1.1

Note that forced operation is also possible in COOL/HEAT mode.

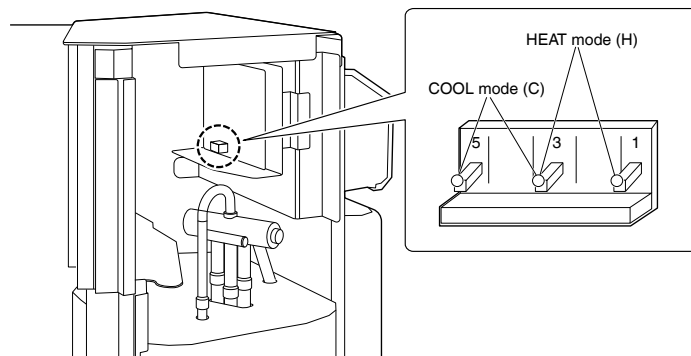

When attaching the optional drain pan heater (excluding 2MXTH models)

⚠ WARNING
Do not remove the switch cover unless the power has been turned off. (Risk of electric shock)

- 1) Attach the drain pan heater in accordance with the installation manual included with the drain pan heater.
- 2) Using a tool such as nippers, cut the jumper (J_DP) on the service PC-board.

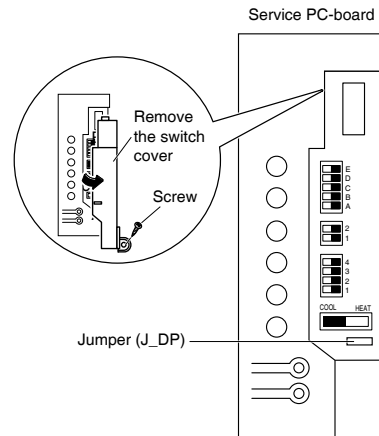

Pump Down Operation

⚠ WARNING
Do not remove the switch cover unless the power has been turned off. (Risk of electric shock)

In order to protect the environment, be sure to pump down when relocating or disposing of the unit.

- 1) Remove the valve caps from liquid stop valve and gas stop valve.
- 2) Begin forced cooling operation.
- 3) After 3 to 5 minutes, close the liquid stop valve with a hexagonal wrench.
- 4) After 3 to 4 minutes, close the gas stop valve and stop forced cooling operation.
- 5) Attach the valve caps once procedures are complete.

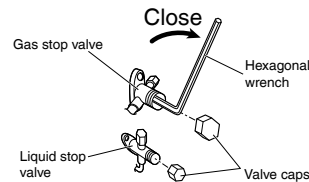

Forced cooling operation

- When using this outdoor unit, no need to operate the indoor unit.

- 1) Turn off the power.
 - 2) Remove the service lid (2 screws).
 - 3) Remove the service PC-board switch cover (1 screw).
 - 4) Switch SW5 and SW6 to off.
 - 5) Turn the operation mode switch (SW2) to COOL.
 - 6) Screw the service PC-board switch cover back on (1 screw).
 - 7) Turn on the power.
 - 8) Push the forced operation switch (SW1) above the service PC-board cover. (The operation will start.)
- Forced cooling operation will stop automatically after about 11 to 15 minutes. To stop the operation, push the forced operation switch (SW1).

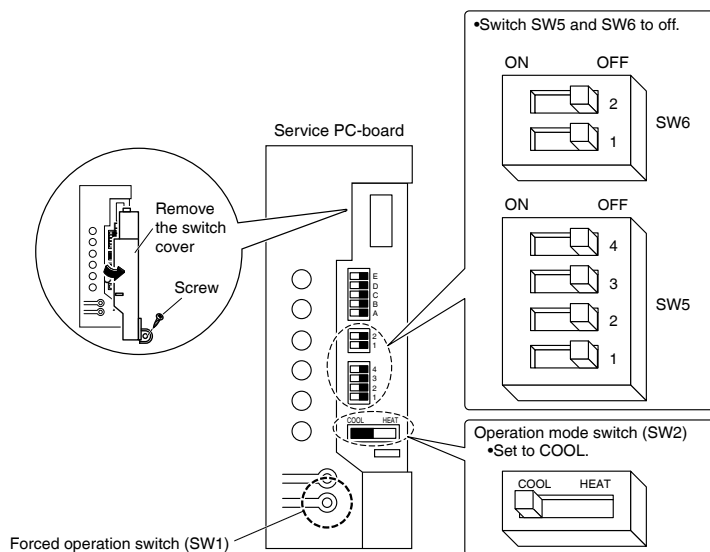

Trial Operation and Testing

- Before starting the trial operation, measure the voltage at the primary side of the circuit breaker.
- Check that all liquid and gas stop valves are fully open.
- Check that piping and wiring all match. The wiring error check can be conveniently used for underground wiring and other wiring that cannot be directly checked. However, if the outside air temperature is **41°F (5°C) or less**, the wiring error check function will not operate.
- When trial operation is conducted directly after the circuit breaker is turned on, in some cases such as the outdoor temperature is below 40°F (5°C) no air will be output for about 15 to 25 minutes in order to protect the air conditioner.

1. Wiring error check

This product is capable of automatic correction of wiring errors.

Press the wiring error check switch on the outdoor unit service PC-board. However, the wiring error check switch will not function for 3 minutes after the safety breaker is turned on. About 15-20 minutes after the switch is pressed, the errors in the connection wiring will be corrected.

The service monitor LEDs indicate whether or not correction is possible, as shown in the table below. For details on how to read the LED display, refer to the collective indications label on the reverse side of the top plate or the service manual.

If self-correction is not possible, check the indoor unit wiring and piping in the usual manner.

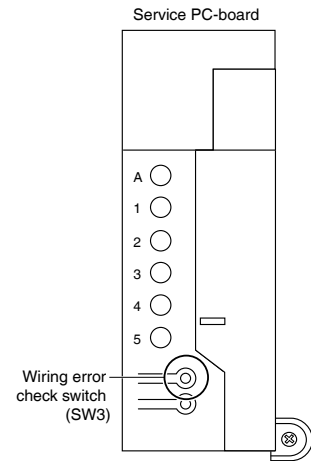

| LED | 1 | 2 | 3 | 4 | 5 | Message |
|--------|---------------------------------------|---|---|---|---|---------------------------------|
| Status | All Flashing | | | | | Automatic correction impossible |
| | Flashing One after another | | | | | Automatic correction completed |
| | ☀ (One or more of LEDs 1 to 5 are ON) | | | | | Abnormal stop [Note. 3] |

Wiring correct example

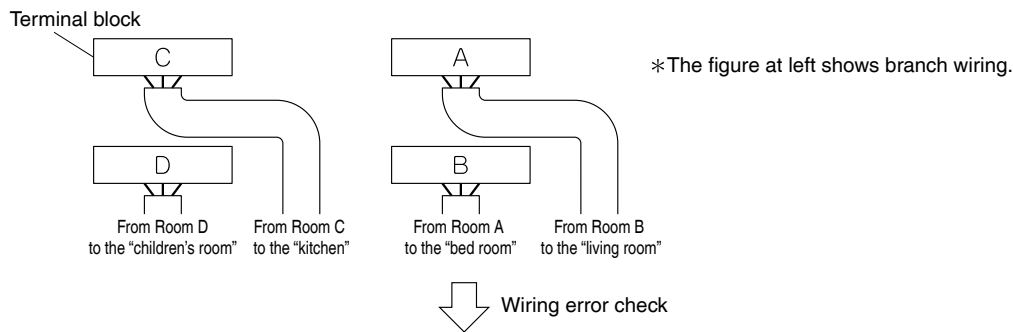

↓ Wiring error check

LED lighting sequence after a wiring correction.

Order of LED flashing: 2 → 1 → 3 → 4 [Note. 1]

NOTE

- 1) For two rooms, LED 3,4 and 5 are not displayed, and for three rooms, LED 4 and 5 is not displayed, and for four rooms, LED 5 is not displayed.
- 2) After wiring error check operation is completed, LED indication will continue until ordinary operation starts. This is normal.
- 3) Follow the product diagnosis procedures. (Details of product error diagnosis are listed on the reverse side of the top plate.)

2. Trial operation and testing

- During the trial operation, first check the operation of each unit individually. After this, check the simultaneous operation of all indoor units. Check both COOL and HEAT operations.

2-1. Measure the supply voltage and make sure that it is within the specified range.

2-2. In COOL operation, select the lowest programmable temperature; in HEAT operation, select the highest programmable temperature.

- When operating the air conditioner in COOL operation in winter, or HEAT operation in summer, activate trial operation mode by following the instructions in the installation manual for the indoor unit.

2-3. Carry out the trial operation following the instructions in the operation manual to ensure that all functions and parts, such as the movement of the flap, are working properly.

- To protect the air conditioner, restart operation is disabled for 3 minutes after the system has been turned off.
- When trial operation is conducted in HEAT operation directly after the circuit breaker is turned on, in some cases no air will be output for about 3 to 20 minutes in order to protect the air conditioner.
- During COOL operation, frost may form on the gas stop valve or other parts. This is normal.

2-4. After running the unit for about 20 minutes, measure the temperatures at the indoor unit inlet and outlet.

- If the measurements are above the values shown in the table below, then they are normal.

| | COOL operation | HEAT operation |
|---|------------------|-------------------|
| Temperature difference between inlet and outlet | About 14°F (8°C) | About 36°F (20°C) |

(When running in one room)

2-5. After trial operation is complete, set the temperature to a normal level (78°F to 82°F (26°C to 28°C) in COOL operation, 68°F to 75°F (20°C to 24°C) in HEAT operation).

- The air conditioner draws a small amount of power in its standby mode. If the system is not to be used for some time after installation, shut off the circuit breaker to eliminate unnecessary power consumption.
- If the circuit breaker trips to shut off the power to the air conditioner, the system will restore the original operation mode when the circuit breaker is opened again.

3. Test items

| Test item | Symptom | Check |
|---|--|-------|
| Indoor and outdoor units are installed securely. | Fall, vibration, noise | |
| No refrigerant gas leaks. | Incomplete cooling/heating function | |
| Refrigerant gas and liquid pipes and indoor drain hose extension are thermally insulated. | Water leakage | |
| Draining line is properly installed. | Water leakage | |
| System is properly grounded. | Electrical leakage | |
| Only specified wires are used for all wiring, and all wires are connected correctly. | No operation or burn damage | |
| Indoor or outdoor unit's air inlet or air outlet are unobstructed. | Incomplete cooling/heating function | |
| Stop valves are opened. | Incomplete cooling/heating function | |
| Pipes and wires are connected to the corresponding terminal blocks/connection ports for the connected unit. | Incomplete cooling/heating function | |
| The priority room setting is set for only 1 room. | The priority room setting will not function. | |
| Indoor unit properly receives remote control commands. | No operation | |

Part 3 Operation Manual

| | |
|-------------------------------|-----|
| 1. Operation Manual List..... | 84 |
| 2. Operation Manual | 85 |
| 2.1 CTXV07, FTXV09/12 | 85 |
| 2.2 FTXV15/18/24..... | 118 |

1. Operation Manual List

| Model | Operation Manual | Reference Page | Wireless R/C | Wired R/C |
|-------------|------------------|----------------|--------------|---------------------------------------|
| CTXV07AVJU9 | 3P741457-1E | 85 | ARC480A83 | (BRC073A6), (BRC944B2) (Option) |
| FTXV09AVJU9 | | | | |
| FTXV12AVJU9 | | | | |
| FTXV15AVJU9 | 3P741457-2E | 118 | | |
| FTXV18AVJU9 | | | | |
| FTXV24AVJU9 | | | | |



2. Operation Manual

2.1 CTXV07, FTXV09/12

Read Before Operation

Safety Considerations





Refer also to the General Safety Considerations in the separate booklet.

| | |
|---|--|
|  | Read the precautions in this manual carefully before operating the unit. |
|  | This appliance is filled with R32. |

Read these **Safety Considerations for Operations** carefully before operating an air conditioner or heat pump.

Make sure that the unit operates properly during the startup operation. Instruct the user on how to operate and maintain the unit. Inform users that they should store this operation manual with the installation manual for future reference.

Meanings of **DANGER**, **WARNING**, **CAUTION**, and **NOTE** Symbols:

-  **DANGER** Indicates an imminently hazardous situation which, if not avoided, will result in death or serious injury.
-  **WARNING** Indicates a potentially hazardous situation which, if not avoided, could result in death or serious injury.
-  **CAUTION** Indicates a potentially hazardous situation which, if not avoided, may result in minor or moderate injury. It may also be used to alert against unsafe practices.
-  **NOTE** Indicates situations that may result in equipment or property-damage accidents only.

DANGER

- Do not install the unit in an area where flammable materials are present due to risk of explosion resulting in serious injury or death.
- Any abnormalities in the operation of the air conditioner or heat pump, such as smoke or fire, could result in severe injury or death. Turn off the power and contact your dealer immediately.
- Refrigerant gas may produce toxic gas if it comes into contact with fire, such as from a fan heater, stove, or cooking device. Exposure to this gas could cause severe injury or death.
- For refrigerant leakage, consult your dealer. Refrigerant gas is heavier than air and replaces oxygen. A massive leak could lead to oxygen depletion, especially in basements, and an asphyxiation hazard could occur leading to serious injury or death.
- If equipment utilizing a burner is used in the same room as the air conditioner or heat pump, there is the danger of oxygen deficiency which could lead to an asphyxiation hazard resulting in serious injury or death. Be sure to ventilate the room sufficiently to avoid this hazard.
- Safely dispose of the packing materials. Packing materials, such as nails and other metal or wooden parts, may cause stabs or other injuries.

- Tear apart and throw away plastic packaging bags so that children will not play with them. Children playing with plastic bags face the danger of death by suffocation.

WARNING

- Contact your dealer for repair and maintenance. Improper repair and maintenance may result in water leakage, electric shock, and fire. Only use accessories made by Daikin that are specifically designed for use with the equipment and have them installed by a professional.
- Contact your dealer to move and reinstall the air conditioner or heat pump. Incomplete installation may result in water leakage, electric shock, and fire.
- Never let the indoor unit or the remote controller get wet. Water can cause an electric shock or a fire.
- Never use flammable spray such as hair spray, lacquer, or paint near the unit. Flammable spray may cause a fire.
- When a fuse blows out, never replace it with one of incorrect ampere ratings or different wires. Always replace any blown fuse with a fuse of the same specification.
- Never remove the fan guard of the unit. A fan rotating at high speed without the fan guard is very dangerous.
- Never inspect or service the unit by yourself. Contact a qualified service person to perform this work.
- Turn off all electrical power before doing any maintenance to avoid the risk of serious electric shock; never sprinkle or spill water or liquids on the unit.
- Do not touch the switch with wet fingers. Touching a switch with wet fingers can cause electric shock.
- Do not allow children to play on or around the unit to prevent injury.
- The heat exchanger fins are sharp enough to cut. To avoid injury wear gloves or cover the fins while working around them.
- Do not put a finger or other objects into the air inlet or air outlet. The fan is rotating at high speed and will cause injury.
- Check the unit foundation for damage on a continuous basis, especially if it has been in use for a long time. If left in a damaged condition the unit may fall and cause injury.
- Placing a flower vase or other containers with water or other liquids on the unit could cause a shock or fire if a spill occurs.
- Do not touch the air outlet or horizontal blades while the swing flap is in operation because fingers could get caught and injured.
- Never touch the internal parts of the controller. Do not remove the front panel because some parts inside are dangerous to touch. To check and adjust internal parts, contact your dealer.
- Do not use means to accelerate the defrosting process or to clean, other than those recommended by the manufacturer.
- The appliance must be stored in a room without continuously operating ignition sources (for example: open flames, an operating gas appliance or an operating electric heater).
- Do not pierce or burn.
- Be aware that refrigerants may not contain an odor.

Read Before Operation

⚠ CAUTION

- Do not use the air conditioner or heat pump for any other purposes other than comfort cooling or heating. Do not use the unit for cooling precision instruments, food, plants, animals or works of art.
 - Do not place items under the indoor unit as they may be damaged by condensates that may form if the humidity is above 80% or if the drain outlet gets blocked.
 - Before cleaning, stop the operation of the unit by turning the power off or by pulling the supply cord out from its receptacle. Otherwise, an electric shock and injury may result.
 - Do not wash the air conditioner or heat pump with excessive water. An electric shock or fire may result.
 - Avoid placing the controller in a spot which may be splashed with water. Water entering the controller may cause an electric shock or damage the internal electronic parts.
 - Do not operate the air conditioner or heat pump when using a room-fumigation type of insecticide. Failure to observe this could cause the chemicals to be deposited in the unit and can endanger the health of those who are hypersensitive to chemicals.
 - Do not turn off the power immediately after stopping operation. Always wait for at least 5 minutes before turning off the power. Otherwise, water leakage may occur.
 - The appliance is not intended for use by young children or infirm persons without supervision.
 - The remote controller should be kept away from children so they cannot play with it.
 - Consult with the installation contractor for cleaning.
 - Incorrect cleaning of the inside of the air conditioner or heat pump could make the plastics parts break and cause water leakage or electric shock.
 - Do not touch the air inlet or aluminum fin of the air conditioner or heat pump as they can cut and cause injury.
 - Do not place objects in direct proximity of the outdoor unit. Do not let leaves and other debris accumulate around the unit. Leaves are a hotbed for small animals which can enter the unit. Once inside the unit, animals can cause the unit to malfunction, and cause smoke or fire when they make contact with electrical parts.
- Do not wipe the controller operation panel with benzene, thinner, chemical dust cloth, etc. The panel may get discolored or the coating can peel off. If it is heavily dirty, soak a cloth in water-diluted neutral detergent, squeeze it well and wipe the panel clean. Then wipe it with another dry cloth.
 - Dismantling of the unit, disposal of the refrigerant, oil, and additional parts, should be done in accordance with the relevant local, state, and national regulations.
 - Operate the air conditioner or heat pump in a sufficiently ventilated area and not surrounded by obstacles. Do not use the air conditioner or heat pump in the following places.
 - a. Places with a mist of mineral oil, such as cutting oil.
 - b. Locations such as coastal areas where there is a lot of salt in the air.
 - c. Locations such as hot springs where there is a lot of sulfur in the air.
 - d. Locations such as factories where the power voltage varies a lot.
 - e. In cars, boats, and other vehicles.
 - f. Locations such as kitchens where oil may splatter or where there is steam in the air.
 - g. Locations where equipment produces electromagnetic waves.
 - h. Places with an acid or alkaline mist.
 - i. Places where fallen leaves can accumulate or where weeds can grow.
 - Take snow protection measures. Contact your dealer for the details of snow protection measures, such as the use of a snow protection hood.
 - Do not attempt to do electrical work or grounding work unless you are licensed to do so. Consult with your dealer for electrical work and grounding work.
 - Pay attention to operating sound. Be sure to use the following places:
 - a. Places that can sufficiently withstand the weight of the air conditioner or heat pump yet can suppress the operating sound and vibration.
 - b. Places where warm air from the air outlet of the outdoor unit or the operating sound of the outdoor unit does not annoy neighbors.
 - Make sure that there are no obstacles close to the outdoor unit. Obstacles close to the outdoor unit may drop the performance of the outdoor unit or increase the operating sound of the outdoor unit.
 - Consult your dealer if the air conditioner or heat pump in operation generates unusual noise.
 - Make sure that the drainpipe is installed properly to drain water. If no water is discharged from the drainpipe while the air conditioner or heat pump is in the cooling mode, the drainpipe may be clogged with dust or dirt and water leakage from the indoor unit may occur. Stop operating the air conditioner or heat pump and contact your dealer.
 - Do not spray the air conditioner unit with any deodorizers, etc. It may cause the unit to malfunction.

⚠ NOTE

- Never press the button of the remote controller with a hard, pointed object. The remote controller may be damaged.
- Never pull or twist the electric wire of the remote controller. It may cause the unit to malfunction.
- Do not place appliances that produce open flames in places that are exposed to the airflow of the unit or under the indoor unit. It may cause incomplete combustion or deformation of the unit due to the heat.
- Do not expose the controller to direct sunlight. The LCD display can become discolored and may fail to display the data.

FTP002(R32)-U

Read Before Operation

Names of Parts

Indoor Unit

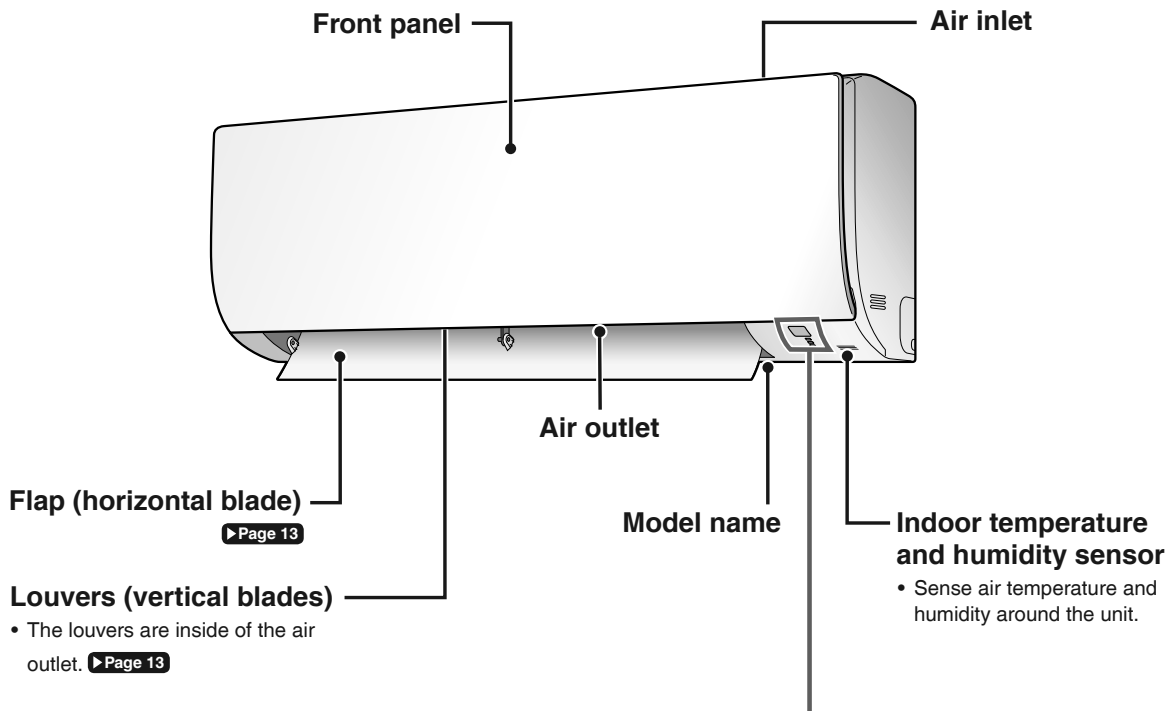

Display

Signal receiver

- Receives signals from the remote controller.
- When the unit receives a signal, you will hear a beep sound.

| Case | Sound type |
|-----------------|------------|
| Operation start | beep-beep |
| Setting changed | beep |
| Operation stop | long beep |

OPERATION lamp (Green)
▶Page 10

TIMER lamp (Orange)
▶Page 16, 17

Wireless LAN connection adapter lamp (Orange)
▶Page 8, 21, 22

Indoor unit ON/OFF switch

- Press this switch once to start operation. Press once again to stop it.
- For the operation mode setting, refer to the following table.

| Mode | Temperature setting | Airflow rate |
|------|---------------------|--------------|
| AUTO | 77°F (25°C) | AUTO |

- This switch can be used when the remote controller is missing or out of batteries.

Read Before Operation

■ **Open the front panel**

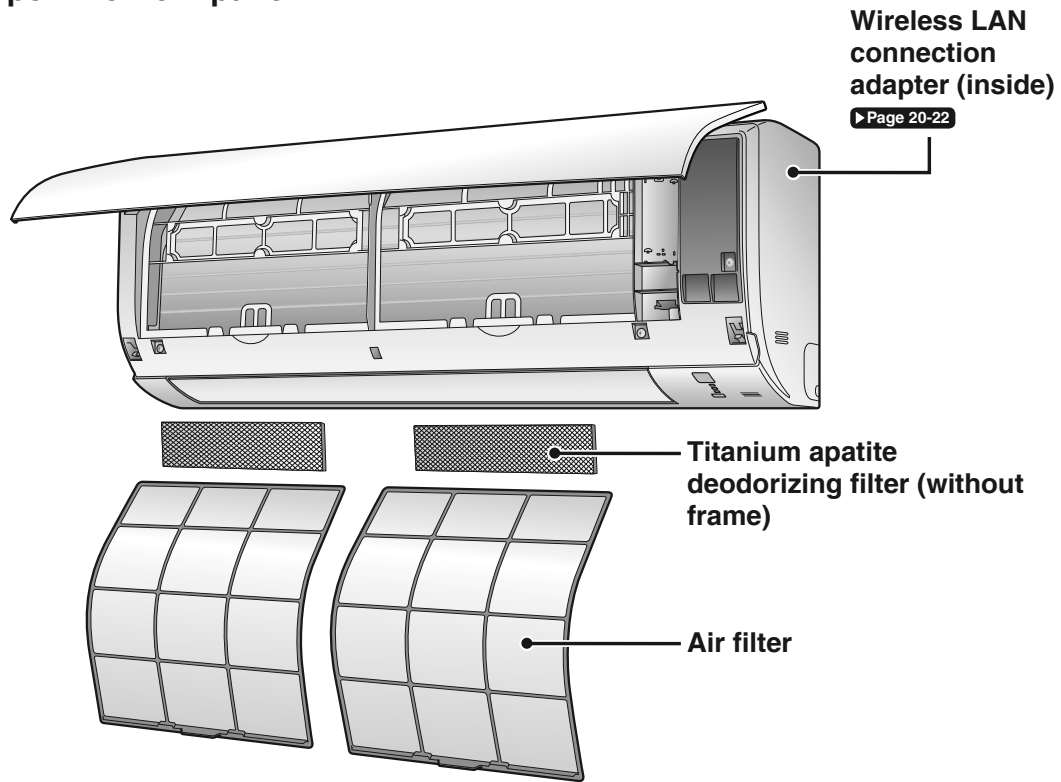

Outdoor Unit

• The appearance of the outdoor unit may differ between different models.

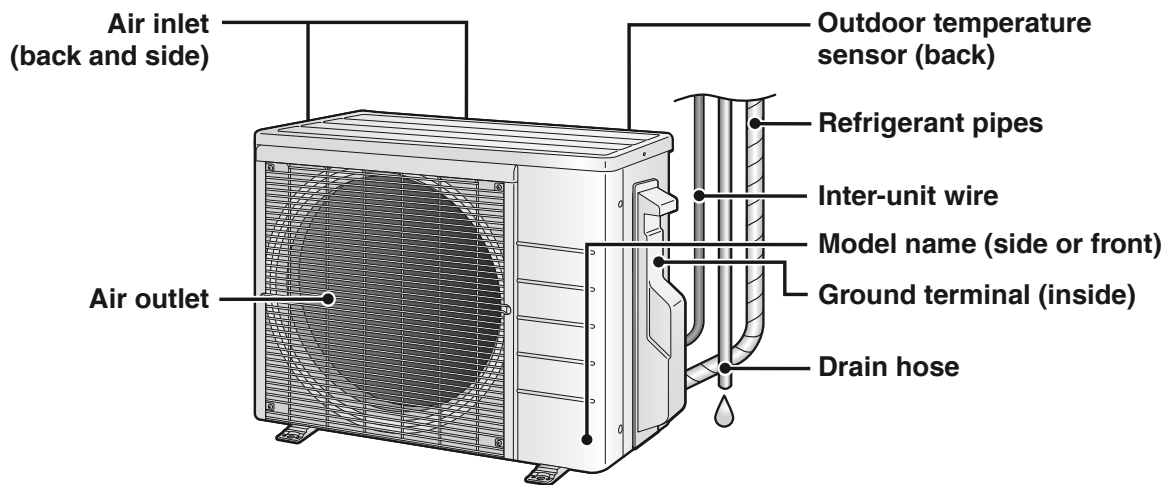

Read Before Operation

Names of Parts

Remote Controller

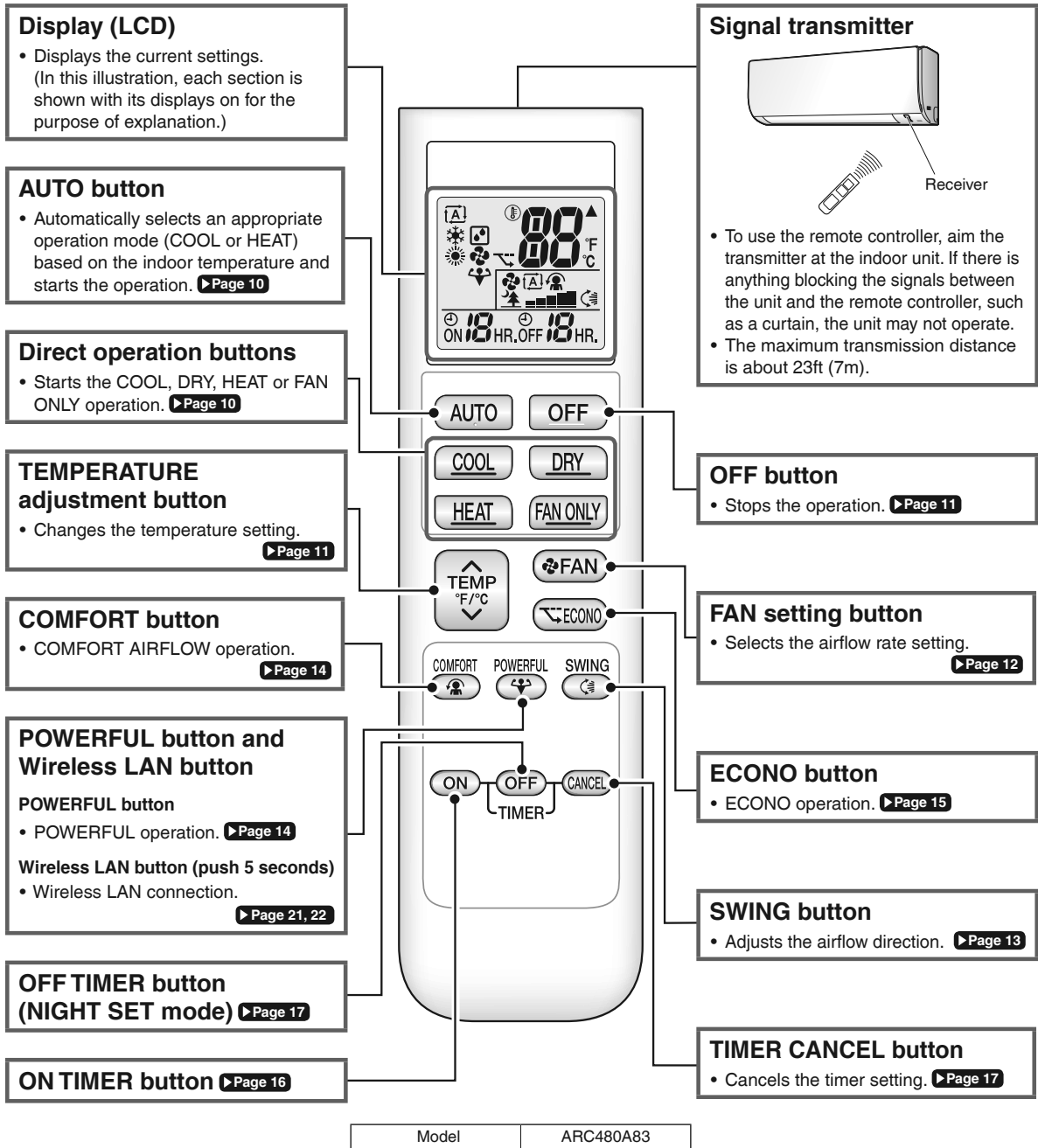

Read Before Operation

Wireless LAN connection adapter

The Wireless LAN connection adapter function requires the Daikin One Home for connecting to the air conditioner and controlling it via your smartphone or tablet over your network.

Attention

- Wireless LAN sends and receives data using radio waves so there is a risk of transmitted data being subject to eavesdropping and illegal access. When using wireless LAN, manage the SSID/KEY of the wireless LAN connection adapter, the SSID/KEY of the wireless router, and the app login information so that they will not be known to others, and ensure that you have an adequate understanding of the risks involved. [▶ Page 6](#)
In the case that the product is accessed and operated illegally, turn off the wireless LAN connection adapter function. [▶ Page 22](#)
- Do not use this product near a microwave oven. (This can affect wireless LAN communications.)
- This product cannot be directly connected to the communication line of a telecommunications carrier (internet service provider, etc.). When connecting to the internet, be sure to connect via a device such as a router.
When the wireless LAN connection adapter function is turned on, the right side of the air conditioner may become slightly warm, but this is not an abnormality.

⚠ WARNING

- While the Wireless LAN connection adapter operates, it may affect persons using cardiac pacemakers or defibrillators. This product may cause electromagnetic interference.
- While the Wireless LAN connection adapter operates, it may affect automatic doors or fire alarm equipment. This product may cause faulty behavior of the equipment.

Configuration

- The user is responsible for providing the following items before using this product:
 - Smartphone or tablet PC
 - Internet line and communicating device (Modem/router or similar device)
 - Wireless LAN access point
 - Application name: [Daikin One Home] (free)
- For details on the installation method for the Daikin One Home, please see [▶ Page 21](#).

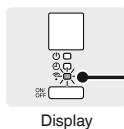

Wireless LAN connection adapter lamp (Orange)

- The Wireless LAN connection adapter lamp lights when connecting to a router (Wireless LAN access point). Please see [▶ Page 21](#).
- For Wireless LAN connection adapter operation, please see [▶ Page 22](#).

⚠ WARNING

When operating an air conditioner from outside the home, it is not possible to check the air conditioner or the surroundings of the air conditioner, or the state of the people in the room. Therefore, make sure to adequately check for safety before use. In some cases, there is a risk of death, severe injury, or property damage.

- **Check the following in advance (while at home)**
 - Timer settings or reservations that other users may have made. (There is a risk of causing harm to the health of people, animals, or plants in the home if operation starts and stops unexpectedly)
 - There are no signs of abnormality in the air conditioning. Harm will not be caused to people or to the room if there is a change in airflow. (For example, that there are no objects nearby that might blow over) (There is a risk of objects falling due to airflow and causing fire, bodily injury, or staining of household items)
- **Check the following before/while operating a unit from outside the home**
 - If you know that there is someone at home, inform the person when turning the air conditioner on or off from outside the home. (If someone at home is standing on something such as a stool, the air conditioner turning on or off unexpectedly could surprise them and cause them to fall or topple over. Additionally, a sudden change in the indoor/outdoor temperature could harm the health of people at home)
 - The air conditioner can be turned off and temperature adjustment can be made using a remote controller in the home.
 - Do not use the function if the only people at home are persons who are unable to make adjustments to temperature or other settings themselves, such as young children, disabled persons, or elderly persons.
 - Regularly check the settings and operating status of the air conditioner. (Sudden changes in indoor/outdoor temperature pose a health hazard. There is a risk of harm to animals and plants)
If an error occurs during operation, immediately turn off the air conditioner and contact your dealer.
Double check the display to confirm that the power is off.

Read Before Operation

Preparation Before Operation

CAUTION

Incorrect handling of batteries can result in injury from battery leakage, rupturing or heating, or lead to equipment failure.

Please observe the following precautions and use safely.

- If the alkaline solution from the batteries should get in the eyes, do not rub the eyes. Instead, immediately flush the eyes with tap water and seek the attention of a medical professional.
- Keep batteries out of reach of children. In the event that batteries are swallowed, seek the immediate attention of a medical professional.
- Do not expose batteries to heat or fire. Do not disassemble or modify batteries. The insulation or gas release vent inside the battery may be damaged, resulting in battery leakage, rupturing, or heating.
- Do not damage or peel off labels on the batteries.

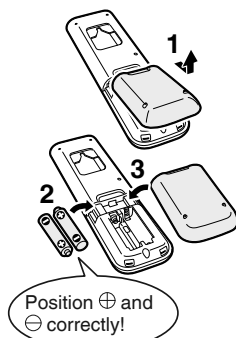

To insert the batteries

- 1. Remove the back cover by sliding and then slightly lifting it.**
- 2. Insert 2 dry batteries AAA.LR03 (alkaline).**
- 3. Replace the back cover.**

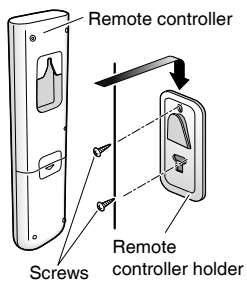

To attach the remote controller holder to a wall

- 1. Choose a place where the signals reach the unit.**
- 2. Attach the holder to a wall, a pillar, or similar location with the screws supplied with the holder.**
- 3. Hang the remote controller on the remote controller holder.**

Fahrenheit/Celsius display switch

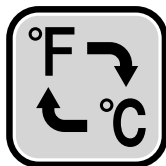

Press  and  (TIMER button) simultaneously for about 5 seconds.

- The temperature will be displayed in Celsius when it is presently displayed in Fahrenheit, and vice versa.
- The switch operation is only possible when the temperature is being displayed.
- A reception sound will go off for the transmission of set temperature to the indoor unit at the time of setting the Fahrenheit/Celsius display change function.

Turn on the circuit breaker

- After the power is turned on, the flap of the indoor unit opens and closes once to set the reference position.

NOTE

Notes on batteries

- To avoid possible injury or damage from battery leakage or rupturing, remove the batteries when not using the product for long periods of time.
- The standard replacement time is about 1 year. Both batteries should be replaced at the same time. Be sure to replace them with new dry batteries AAA.LR03 (alkaline).
- If the remote controller display begins to fade and signal reception begins to decline, replace the batteries with new batteries. Owing to usage conditions, battery consumption may be accelerated.
- The batteries supplied with the remote controller are for initial operation. The batteries may run out in less than 1 year.

Notes on remote controller

- Do not drop the remote controller. Do not get it wet.
- If dirt becomes an issue, wipe with a soft dry cloth.

Fahrenheit/Celsius display change function of remote controller

- The set temperature may increase when the display is changed to Celsius from Fahrenheit, because a fraction of 0.5°C is rounded up.
- Example: A set temperature of 65°F (equivalent to 18.5°C) will be converted into 19°C.

When the display is changed to Fahrenheit again, the set temperature will be converted into 66°F (equivalent to 19°C) instead of the original set temperature (65°F) but a set temperature of 66°F (equivalent to 19°C) will be converted into 19°C with no temperature change.

Basic Operation



AUTO · COOL · DRY · HEAT · FAN ONLY Operation

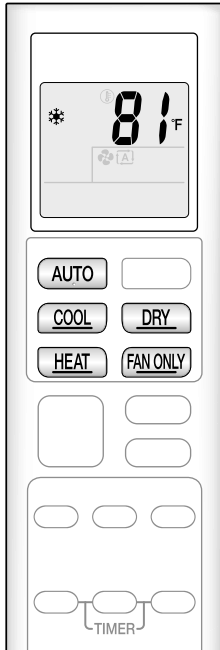

The air conditioner operates with the operation mode of your choice.

To start operation

AUTO operation

- To automatically select an appropriate temperature and operation mode.

Press **AUTO** .



COOL operation

- To lower the temperature.

Press **COOL** .



DRY operation

- To lower the humidity.

Press **DRY** .



HEAT operation

- To raise the temperature.

Press **HEAT** .



FAN ONLY operation

- To circulate air in the room.

Press **FAN ONLY** .



- The OPERATION lamp lights green.

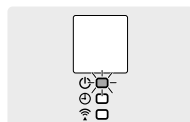

Display

NOTE

Notes on AUTO operation

- In AUTO operation, the system selects an appropriate operation mode (COOL or HEAT) based on the indoor temperature and starts the operation.
- The system automatically reselects setting at a regular interval to bring the indoor temperature to the user-setting level.

Note on DRY operation

- Eliminates humidity while maintaining the indoor temperature as much as possible. It automatically controls temperature and airflow rate, so manual adjustment of these functions is unavailable.

Basic Operation



AUTO · COOL · DRY · HEAT · FAN ONLY Operation

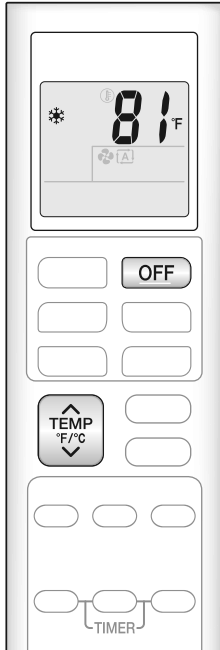

To stop operation

Press **OFF** .

- The OPERATION lamp goes off.

To change the temperature setting

Press **TEMP** .

- Press **▲** to raise the temperature and press **▼** to lower the temperature.

| COOL operation | HEAT operation | AUTO operation | DRY or FAN ONLY operation |
|----------------------|----------------------|----------------------|--|
| 64-90°F (18-32°C) | 50-86°F (10-30°C) | 64-86°F (18-30°C) | The temperature setting cannot be changed. |

Tips for saving energy

Keeping the temperature setting at a moderate level helps save energy.

- Recommended temperature setting
 - For cooling: 78-82°F (26-28°C)
 - For heating: 68-75°F (20-24°C)

Cover windows with a blind or a curtain.

- Blocking sunlight and air from outdoors increases the cooling (heating) effect.

Keep the air filters clean.

- Clogged air filters cause inefficient operation and waste energy. Clean them once in about every 2 weeks. [▶ Page 26](#)

If you are not going to use the air conditioner for a long period, for example in spring or autumn, turn off the circuit breaker.

- The air conditioner always consumes a small amount of electricity even while it is not operating.



Basic Operation



Adjusting the Airflow Rate

You can adjust the airflow rate to increase your comfort.

To adjust the airflow rate setting

Press **FAN**.

- Each pressing of **FAN** changes the airflow rate setting in sequence.



- When the airflow is set to “”, quiet operation starts and noise from the indoor unit will become quieter. However, it may become difficult to cool (or warm) the room.
- In the quiet operation mode, the airflow rate is set to a weak level.

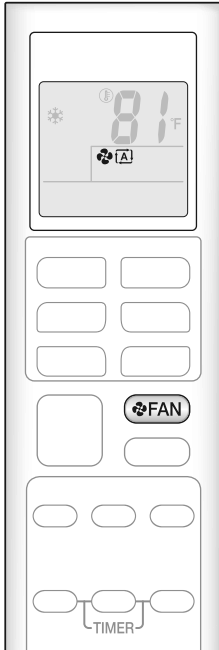

| AUTO, COOL, HEAT and FAN ONLY operation | | | | DRY operation |
|---|--|--|---|---|
| | | | → | |
| | | | | The airflow rate setting cannot be changed. (only AUTO) |
| | | | | AUTO |

NOTE

Note on airflow rate setting

- At smaller airflow rates, the cooling (heating) effect is also smaller.

Note on AUTO airflow rate

- When using AUTO airflow rate, the airflow rate is adjusted according to conditions in the room.

Basic Operation



Adjusting the Airflow Direction

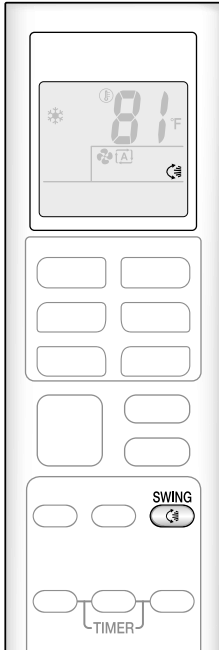

You can adjust the airflow direction to increase your comfort.

⚠ CAUTION

- Always use a remote controller to adjust the angles of the flap. Moving the flap forcibly by hand may cause a malfunction.
- Be careful when adjusting the louvers. Inside the air outlet, a fan is rotating at a high speed.

To start auto swing

Up and down airflow direction

Press  .

- “” is displayed on the LCD.
- The flap (horizontal blade) will begin to swing.

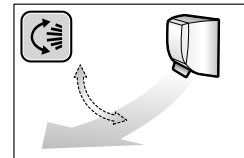

To set the flap at the desired position

- This function is effective while the flap is in auto swing mode.

Press  when the flap reaches the desired position.

- “” disappears from the LCD.

To adjust the louvers at desired position

Hold the knobs and move the louvers (vertical blades).

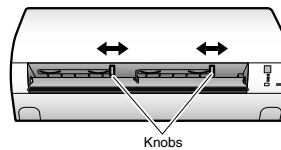

NOTE

Notes on airflow direction setting

- The movable range of the flap varies according to the operation mode.
- If the airflow rate becomes weak during operation, the flap will stop.
When up and down airflow direction is set, the flap will stop in an upward position.

Movable range of the flap

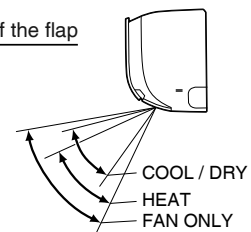

Useful Functions



COMFORT AIRFLOW Operation

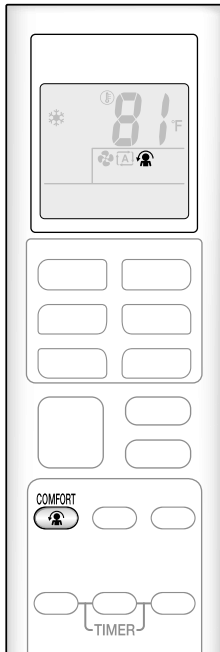

The flow of air will be in the upward direction while in COOL and DRY operation and in the downward direction while in HEAT operation, which will provide a comfortable airflow that will not come in direct contact with people.

To start COMFORT AIRFLOW operation

Press  .

- “” is displayed on the LCD.

| | COOL and DRY operation | HEAT operation | FAN operation |
|----------------|------------------------|----------------|---------------|
| Flap direction | Goes up | Goes down | Not available |
| Airflow rate | AUTO | | |

- When in AUTO operation, the flap direction differs based on the operation mode (COOL or HEAT) as shown in the table above.

To cancel COMFORT AIRFLOW operation

Press  again.

- “” disappears from the LCD.
- The flap will return to the memory position from before COMFORT AIRFLOW operation.



POWERFUL Operation

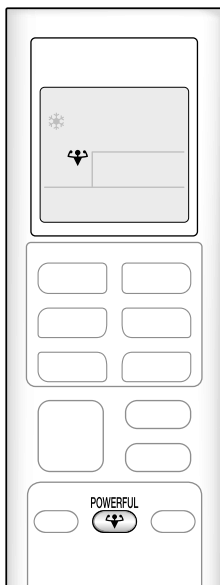

POWERFUL operation quickly maximizes the cooling (heating) effect in any operation mode. In this mode, the air conditioner operates at maximum capacity.

To start POWERFUL operation

Press  .

- “” is displayed on the LCD.
- POWERFUL operation ends in 20 minutes. Then the system automatically operates again with the previous settings which were used before POWERFUL operation.

To cancel POWERFUL operation

Press  again.

- “” disappears from the LCD.

Useful Functions



ECONO Operation

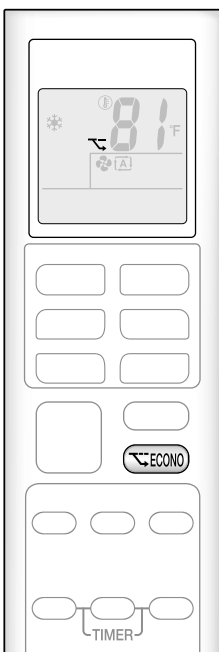

ECONO operation enables efficient operation by limiting the maximum power consumption.

This function is useful to prevent the circuit breaker from tripping when the unit operates alongside other appliances on the same circuit.

To start ECONO operation

Press  .

- “” is displayed on the LCD.
- Not available in FAN ONLY mode.

To cancel ECONO operation

Press  again.



- “” disappears from the LCD.

NOTE

Notes on COMFORT AIRFLOW operation

- The airflow rate will be set to AUTO.
- If the up and down airflow direction is selected, the COMFORT AIRFLOW operation will be canceled.

Notes on POWERFUL operation

- Pressing  causes the settings to be canceled, and “” disappears from the LCD.
- POWERFUL operation will not increase the capacity of the air conditioner if the air conditioner is already in operation with its maximum capacity demonstrated.

- In COOL, HEAT and AUTO operation

To maximize the cooling (heating) effect, the capacity of outdoor unit increases and the airflow rate becomes fixed at the maximum setting.

The temperature and airflow settings cannot be changed in COOL and HEAT operation.

Airflow settings cannot be changed in AUTO operation.



- In DRY operation

The temperature setting is lowered by 1.8°F (1.0°C) and the airflow rate is slightly increased.

- In FAN ONLY operation

The airflow rate is fixed at the maximum setting.

Notes on ECONO operation

- This operation is performed with lower power and therefore may not provide a sufficient cooling (heating) effect.
- Pressing  causes the settings to be canceled, and “” disappears from the LCD.
- If the power consumption level is already low, switching to ECONO operation will not reduce the power consumption.

Some useful functions can be used together.

| | |
|----------------------------|----------------|
| COMFORT AIRFLOW + ECONO | Available |
| POWERFUL + COMFORT AIRFLOW | Not available* |
| POWERFUL + ECONO | Not available* |

*Priority is given to the function of whichever button is pressed last.



ON/OFF TIMER Operation



Timer functions are useful for automatically switching the air conditioner on or off in the morning or at night. You can also use the ON TIMER and OFF TIMER together.

To use ON TIMER operation

Press **ON**.

- Each pressing of **ON** changes the time setting by 1 hour. The time can be set between 1 and 12 hours.
- The TIMER lamp lights orange.

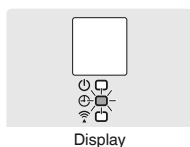

Display

NOTE

In the following cases, set the timer again.

- After the circuit breaker has turned off.
- After a power failure.
- After replacing the batteries in the remote controller.

TIMER Operation



ON/OFF TIMER Operation

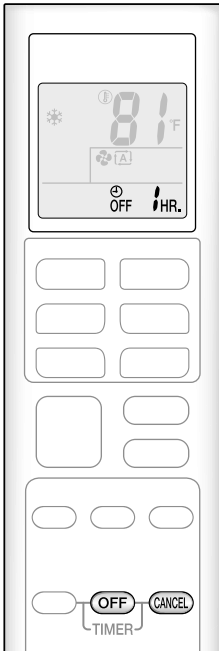

To use OFF TIMER operation

Press **OFF** .

- Each pressing of **OFF** changes the time setting by 1 hour. The time can be set between 1 and 12 hours.
- The TIMER lamp lights orange.

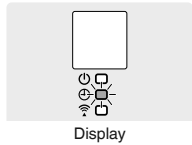

To cancel ON/OFF TIMER operation

Press **CANCEL** .

To combine ON TIMER and OFF TIMER operation

- A sample setting for combining the 2 timers is shown below.
- "ON" and "OFF" are displayed on the LCD.

[Example]

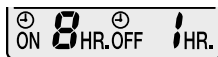

When setting while the unit is operating

- Stops the unit 1 hour later and starts it 7 hours after that.

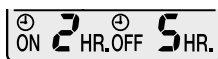

When setting while the unit is stopped

- Starts the unit 2 hours later and stops it 3 hours after that.

NOTE

NIGHT SET mode

- When the OFF TIMER is set, the air conditioner automatically adjusts the temperature setting (0.9°F (0.5°C) up in COOL, 3.6°F (2.0°C) down in HEAT) to prevent excessive cooling (heating) during sleeping hours.

Multi Connection

Note for Multi System

A multi system has one outdoor unit connected to multiple indoor units.

Selecting the operation mode

When the priority room setting is active but the set unit is not operating or when the priority room setting is inactive

When more than one indoor unit is operating, priority is given to the first unit that was turned on.
 In this case, set the units that are turned on later to the same operation mode as the first unit.
 Otherwise, they will enter the standby state, and the OPERATION lamp will blink; this does not indicate malfunction.

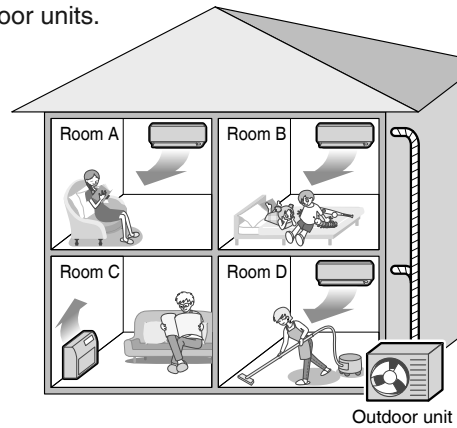

NOTE

Notes on operation mode for a multi system

- COOL, DRY and FAN operation may be used at the same time.
- AUTO operation automatically selects COOL operation or HEAT operation based on the indoor temperature.
 Therefore, AUTO operation is available when selecting the same operation mode as that of the room with the first unit to be turned on.

! CAUTION

- Normally, the operation mode in the room where the unit is first started is given priority, but the following situations are exceptions to this rule.
 If the operation mode of the first room is FAN operation, then using HEAT operation in any room after this will give priority to HEAT operation.
 In this situation, the indoor unit operating in FAN mode will switch to standby, and the OPERATION lamp will blink.

With the priority room setting active

Refer to "Priority room setting" on the next page.

Multi Connection

Note for Multi System

COOL/HEAT mode lock

The COOL/HEAT mode lock requires initial programming during installation. Please consult your authorized dealer for assistance. The COOL/HEAT mode lock sets the unit forcibly to either COOL or HEAT operation. This function is convenient when you wish to set all indoor units connected to the multi system to the same operation mode.

NOTE

- The COOL/HEAT mode lock cannot be activated together with the priority room setting.

Priority room setting (Not available on some models)

The priority room setting requires initial programming during installation. Please consult your authorized dealer for assistance. The room designated as the priority room takes priority in the following situations.

Operation mode priority

- As the operation mode of the priority room takes precedence, you can select a different operation mode from other rooms.

[Example]

- Room A is the priority room in this example.
When COOL operation is selected in room A while operating the following modes in room B, C and D:

| Operation mode in room B, C and D | Status of room B, C and D when the unit in room A is in COOL operation |
|-----------------------------------|---|
| COOL or DRY or FAN | The current operation mode is maintained. |
| HEAT | The unit enters the standby mode. Operation resumes when the room A unit stops operating. |
| AUTO | If the unit is set to COOL operation, it continues. If the unit is set to HEAT operation, it enters the standby mode. Operation resumes when the room A unit stops operating. |

Priority when POWERFUL operation is used

[Example]

- Room A is the priority room in this example.
The indoor units in rooms A, B, C and D are all operating. If the unit in room A enters POWERFUL operation, operation capacity will be concentrated in room A. In such a case, the cooling (heating) efficiency of the units in room B, C and D may be slightly reduced.



Wireless LAN connection

Wireless LAN connection



Web site: <https://daikinone.com/ductless>

For instructions on how to connect your unit to wireless LAN and to your Daikin One Home application, please see the website above.

Contains FCC ID: VPYLB1YA

This device complies with part 15 of the FCC Rules. Operation is subject to the following two conditions:

- (1) This device may not cause harmful interference, and
- (2) This device must accept any interference received, including interference that may cause undesired operation.

FCC CAUTION

Changes or modifications not expressly approved by the party responsible for compliance could void the user's authority to operate the equipment.

This transmitter must not be co-located or operated in conjunction with any other antenna or transmitter.

Contains IC: 772C-LB1YA

This device complies with Industry Canada's applicable licence-exempt RSSs.

Operation is subject to the following two conditions:

- (1) This device may not cause interference; and
- (2) This device must accept any interference, including interference that may cause undesired operation of the device.

This equipment complies with IC radiation exposure limits set forth for an uncontrolled environment and meets RSS-102 of the IC radio frequency (RF)

Exposure rules. This equipment should be installed and operated keeping the radiator at least 7-7/8 inches (20cm) or more away from person's body.

The FCC responsible party is Daikin Comfort Technologies Manufacturing, L.P., and may be contacted by calling (713)-861-2500, or at 19001

Kermier Rd., Waller, TX 77484.

(<https://www.northamerica-daikin.com>)

This device, which was assembled by Daikin Comfort Technologies Manufacturing, L.P., contains a component that is classified as an intentional radiator.

This intentional radiator has been certified by the FCC: FCC ID VPYLB1YA.

And this intentional radiator has an industry Canada ID: IC 772C-LB1YA.

The manufacturer of the intentional radiator (model no. Type1YA) is Murata Manufacturing co., Ltd (www.murata.com).

This equipment complies with FCC radiation exposure limits set forth for an uncontrolled environment and meets the FCC radio frequency (RF) Exposure Guidelines. This equipment should be installed and operated keeping the radiator at least 7-7/8 inches (20cm) or more away from person's body.

Changes or modifications not expressly approved by the party responsible for compliance could void the user's authority to operate the equipment.

NOTE: This equipment has been tested and found to comply with the limits for a Class B digital device, pursuant to part 15 of the FCC Rules. These limits are designed to provide reasonable protection against harmful interference in a residential installation. This equipment generates, uses and can radiate radio frequency energy and, if not installed and used in accordance with the instructions, may cause harmful interference to radio communications. However, there is no guarantee that interference will not occur in a particular installation. If this equipment does cause harmful interference to radio or television reception, which can be determined by turning the equipment off and on, the user is encouraged to try to correct the interference by one or more of the following measures:

- Reorient or relocate the receiving antenna.
- Increase the separation between the equipment and receiver.
- Connect the equipment into an outlet on a circuit different from that to which the receiver is connected.
- Consult the dealer or an experienced radio/TV technician for help.

Mobile Controller



Wireless LAN connection

Application software installation

For Android Phones

- 1) Open [Google Play].
- 2) Search using the application name: [Daikin One Home].
- 3) Follow the directions on the screen to install.

For iOS Phones

- 1) Open the [App Store].
- 2) Search using the application name: [Daikin One Home].
- 3) Follow the directions on the screen to install.

Attention

- The actual application screen layout and content may differ from what is shown. The layout and content of the application screen is subject to change without notice.

Connect the air conditioner to your home network.

1. While operation is stopped, press  and hold the button for 5 seconds.
2. Press  or  and select menu number 3.

- "SP" appears on the LCD.
- "3" blinks.

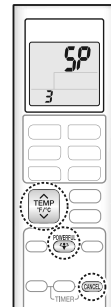

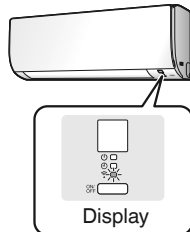

3. Press  to connect to the access point.



The wireless LAN connection adapter lamp blinks quickly.

4. Press  to return to the default screen. No more settings need to be carried out from the remote controller.
5. Open Daikin One Home App and follow the instructions to set up the wireless LAN.
6. When the wireless LAN connection adapter lamp switches from blinking to lit, the connection is complete.

NOTE

- While "SP" is displayed, the options that can be selected using  and  are 1, 3, A, and OFF.
- Perform wireless LAN connection one indoor unit at a time.
- If you are unable to establish a network connection, refer the troubleshooting provided by the Daikin One Home App.
- When the lamp blinks slowly, the connection is not ready. Perform the connection procedure while it blinks quickly.

Mobile Controller

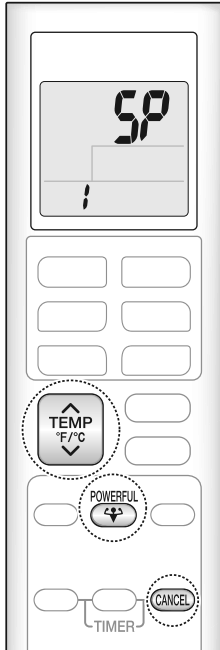

To confirm the wireless LAN connection adapter connection

■ **To confirm**

1. While operation is stopped, press and hold the button for 5 seconds.
2. Press to confirm the selected setting.

- “SP” appears on the LCD.
- “!” blinks.



Check the indoor unit LED.

| Wireless LAN connection adapter lamp | Status |
|--------------------------------------|---|
| Blinking for 1 second | Connection is not ready |
| Blinking for 3 seconds | Please initialize the wireless LAN connection adapter |
| Does not blink or light | Communication is abnormal There is a possibility of equipment failure Please request repair |

To turn off the wireless connection

■ **To use the remote controller**

1. While operation is stopped, press and hold the button for 5 seconds.
2. Press or and select menu OFF.
3. Press and hold the button for 2 seconds to confirm selected setting.
 - The wireless LAN connection adapter lamp turn off.
4. Press to return to the default screen.

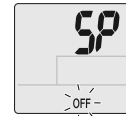

To reset the connection setting to the factory default

- If you want to reset the connection settings, it is possible to initialize the wireless LAN connection adapter to its factory default state. If initialized, data including the network settings and power consumption history will be erased.
- When discarding or transferring to another user, initialize the connection adapter to erase the internal data.

■ **To reset**

1. While operation is stopped, press and hold the button for 5 seconds.
2. Press or and select menu **R**.
3. Press and hold the button for 2 seconds to confirm selected setting.
 - The wireless LAN connection adapter lamp blinks for 1 second.
4. Press to return to the default screen.

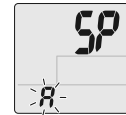

Making Changes to Default Settings

Brightness of Indoor Unit LED Lamps

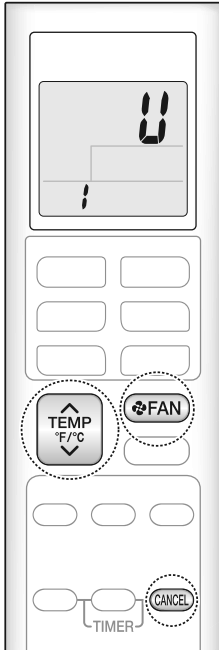

Changes can be made to the setting for the brightness of the LED lamps, to suit your preferences.

1. While operation is stopped, press **FAN** and hold the button for 5 seconds.

2. Press **TEMP F/C** and select menu number **!**.

- “**!**” appears on the LCD.
- “**!**” blinks.

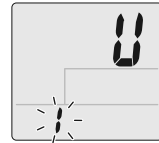

3. Press **FAN**.

4. Press **TEMP F/C** or **TEMP F/C** and select setting option.

- The setting option will blink.

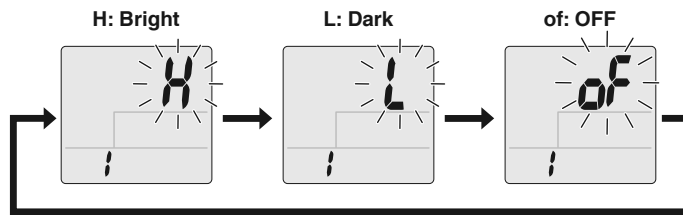

5. Press **FAN**.

6. Press **FAN** and hold the button for 5 seconds to return to the default screen.

NOTE

- Press **CANCEL** to return to the previous screen.
- If no operations are performed for approximately 1 minute, the display will return to the default screen.
- Indoor unit default setting: H (Bright)

Making Changes to Default Settings

Airflow Setting When Indoor Unit Reaches Setpoint

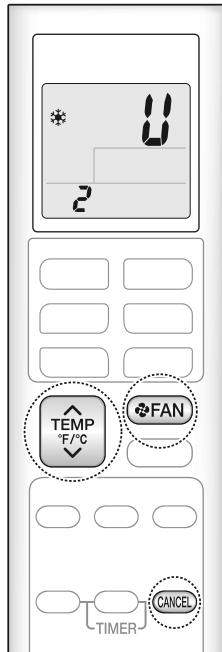

Changes can be made to the setting for airflow rate when unit reaches desired temperature (setpoint), to suit your preferences. This function is effective when COOL operation is selected.

1. While operation is stopped, press **FAN** and hold the button for 5 seconds.

2. Press **TEMP F/C** or **TEMP F/C** and select menu number **2**.

- “U” appears on the LCD.
- “2” blinks.

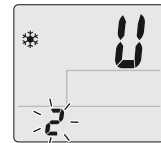

3. Press **FAN**.

4. Press **TEMP F/C** or **TEMP F/C** and select setting option.

- The setting option will blink.

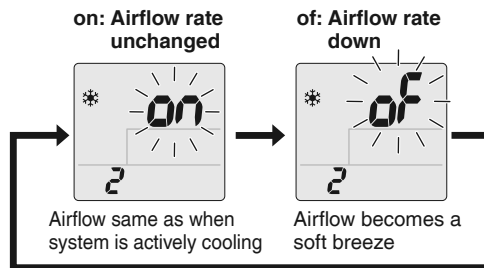

5. Press **FAN**.

6. Press **FAN** and hold the button for 5 seconds to return to the default screen.

NOTE

- Press **CANCEL** to return to the previous screen.
- If no operations are performed for approximately 1 minute, the display will return to the default screen.
- Indoor unit default setting: of (Airflow rate down)

Care

Care and Cleaning

CAUTION

- Before cleaning, be sure to stop the operation and turn off the circuit breaker.
- Do not touch the aluminum fins of the indoor unit. If you touch those parts, this may cause an injury.

Quick reference

Cleaning parts

Front panel

- Wipe with a soft cloth which has been moistened with water or neutral detergent.
- Only neutral detergent may be used.

If dirty



Air filter

- Vacuum dust or wash the filter.

Once every 2 weeks

▶ Page 26

Indoor unit, outdoor unit and remote controller

- Wipe them with a soft cloth.

If dirty

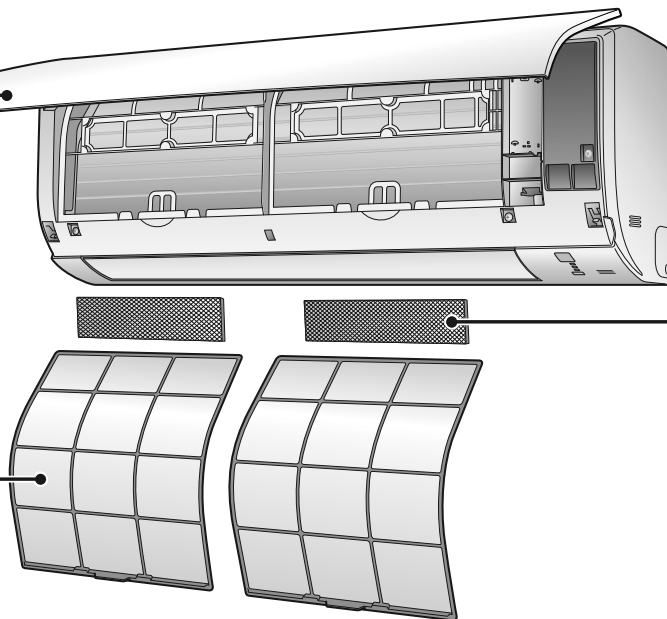

Titanium apatite deodorizing filter (without frame)

- Vacuum dust or replace the filter.

[Cleaning]
Once every 6 months
▶ Page 27

[Replacement]
Once every 3 years
▶ Page 27

NOTE

For cleaning, do not use any of the following:

- Water hotter than 104°F (40°C)
- Volatile liquid such as benzine, gasoline and thinner
- Polishing compounds
- Rough materials such as a scrubbing brush
- Sprays such as deodorizers

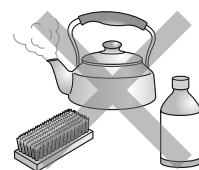

■ Air filter

1. Open the front panel.

- Hold the front panel by the sides and open it.

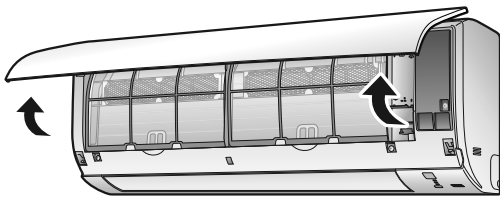

2. Pull out the air filters.

- Push the filter tab at the center of each air filter a little upwards, then pull it down.

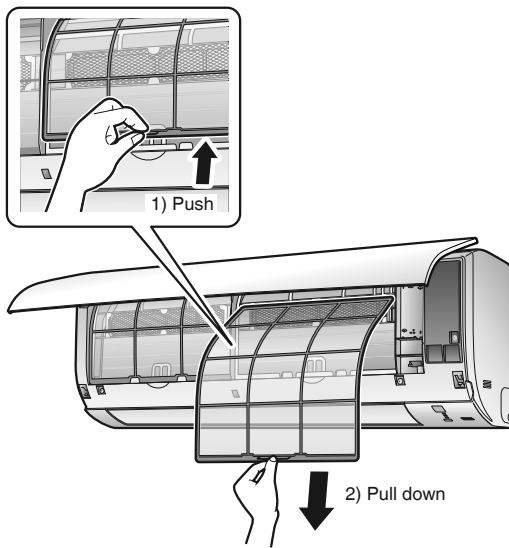

3. Wash the air filters with water or clean them with vacuum cleaner.

- It is recommended to clean the air filters every 2 weeks.

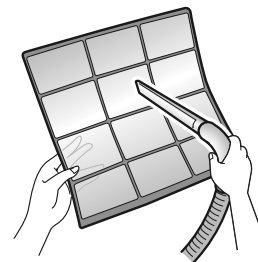

If the dust does not come off easily

- Wash the air filters with neutral detergent thinned with lukewarm water, then dry them up in the shade.



4. Reattach the filters.

5. Close the front panel slowly.

- Press the panel at both sides and the center.

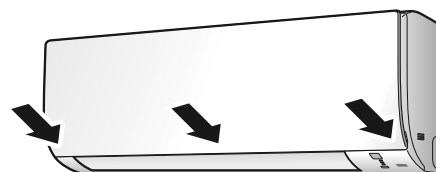

- Make sure that the front panel is securely fixed.

Care

Care and Cleaning

■ Titanium apatite deodorizing filter

1. Open the front panel and pull out the air filters. ▶Page 26

2. Take off the titanium apatite deodorizing filters.

- Remove the filters from the tabs.

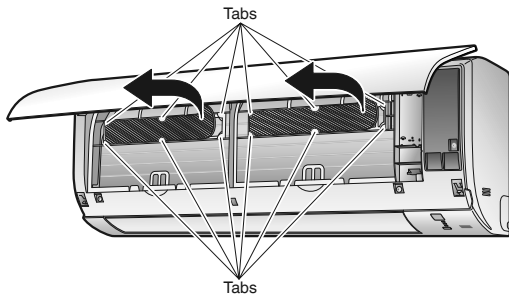

3. Clean or replace the titanium apatite deodorizing filters.

[Cleaning]

3-1 Vacuum dust, and soak in lukewarm water or water for about 10 to 15 minutes if very dirty.

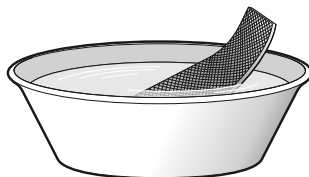

3-2 After washing, shake off remaining water and let them dry in the shade.

- Do not wring out the filter to remove water from it.

[Replacement]

Remove the filter from the tabs and prepare a new one.

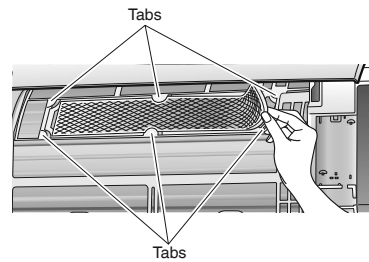

- Dispose of the old filter as non-flammable waste.

4. Insert the titanium apatite deodorizing filters as they were.

- When attaching the filter, check that the filter is properly set in the tabs.
- The titanium apatite deodorizing filter can be attached in any orientation.

5. Reattach the filters. ▶Page 26

6. Close the front panel slowly.

▶Page 26

NOTE

- Operation with dirty filters:
 - cannot deodorize the air,
 - cannot clean the air,
 - results in poor heating or cooling,
 - may cause odor.
- Dispose of old filters as non-flammable waste.
- To order a titanium apatite deodorizing filter, contact the dealer where you bought the air conditioner.

| | |
|-----------------|--|
| Item | Titanium apatite deodorizing filter 1 set (2 pieces) |
| Part No. | KAF970A46 (without frame) |

■ Prior to a long period of non-use

1. Operate the FAN ONLY mode for several hours on a mild day to dry out the inside.

- Press **FAN ONLY**.

2. After operation stops, turn off the circuit breaker for the room air conditioner.

3. Clean the air filters and reattach them. [▶ Page 26](#)

4. To prevent battery leakage, take out the batteries from the remote controller.

- When starting to use the air conditioner again, make sure that the drain hose outlet is not blocked, then turn on the circuit breaker.
An operational check of each component will be carried out automatically. (Also, put the batteries into the remote controller.)

■ We recommend periodical maintenance

- In certain operating conditions, the inside of the air conditioner may get foul after several seasons of use, resulting in poor performance. It is recommended to have periodical maintenance by a qualified contractor in addition to regular cleaning by the user.
- For qualified contractor maintenance, please contact the dealer where you bought the air conditioner.

When the Need Arises

FAQ

Indoor unit

The flap does not start swinging immediately.

- The air conditioner is adjusting the position of the flap. The flap will start moving soon.

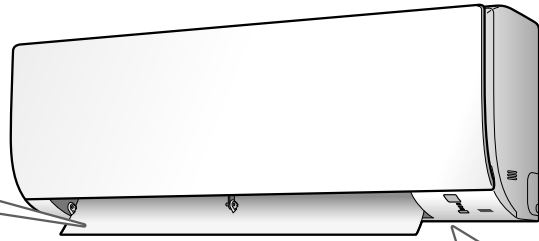

The air conditioner stops generating airflow during HEAT operation.

- Once the set temperature is reached, the airflow rate is reduced and operation stopped in order to avoid generating a cool airflow. Operation will resume automatically when the indoor temperature falls.

HEAT operation stops suddenly and a flowing sound is heard.

- The outdoor unit is defrosting. HEAT operation starts after the frost on the outdoor unit has been removed. This can take about 4 to 12 minutes.

Operation does not start soon.

- **When the unit is turned on again soon after being turned off.**
- **When the mode was reselected.**
 - This is to protect the air conditioner. You should wait for about 3 minutes.

Different sounds are heard.

- **A sound like flowing water**
 - This sound is generated because the refrigerant in the air conditioner is flowing.
 - This is a pumping sound of the water in the air conditioner and can be heard when the water is pumped out from the air conditioner during COOL or DRY operation.
 - The refrigerant flows in the air conditioner even if the air conditioner is not working when the indoor units in other rooms are in operation.
- **Blowing sound**
 - This sound is generated when the flow of the refrigerant in the air conditioner is switched over.
 - If the outdoor temperature is low, this sound is generated when the direction of the flow of the refrigerant in the piping changes at the start of defrost operation, after HEAT operation is stopped and the room temperature is stabilized.
- **Ticking sound**
 - This sound is generated when the cabinet and frame of the air conditioner slightly expand or shrink as a result of temperature changes.
- **Whistling sound**
 - This sound is generated when refrigerant flows during defrosting operation.
- **Clicking sound during operation or idle time**
 - This sound is generated when the refrigerant control valves or the electrical parts operate.
- **Clopping sound**
 - This sound is heard from the inside of the air conditioner when the exhaust fan is activated while the room doors are closed. Open the window or turn off the exhaust fan.

Outdoor unit

Operating sound is loud.

- When frost forms on the heat exchanger of the outdoor unit, the operating sound level increases slightly.

The outdoor unit emits water or steam.

- **In HEAT operation**
 - The frost on the outdoor unit melts into water or steam when the air conditioner is in defrosting operation.
- **In COOL or DRY operation**
 - Moisture in the air condenses into water on the cool surface of the outdoor unit piping and drips.

Blowing sound

- If the outdoor temperature is low, this sound is generated when the direction of the flow of the refrigerant in the piping changes at the start of defrost operation, after HEAT operation is stopped and the room temperature is stabilized.

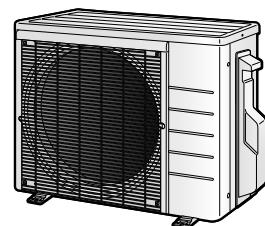

Troubleshooting

Before making an inquiry or a request for repair, please check the following.
If the problem persists, consult your dealer.



Not a problem

This case is not a problem.



Check

Please check again before requesting repairs.

The air conditioner does not operate

| Case | Description / what to check |
|-----------------------------|---|
| OPERATION lamp is off. | <ul style="list-style-type: none"> Has the circuit breaker been tripped or the fuse blown? Is there a power failure? Are batteries set in the remote controller? |
| OPERATION lamp is blinking. | <ul style="list-style-type: none"> Turn off the power with the circuit breaker and restart operation with the remote controller. If the OPERATION lamp is still blinking, check the error code and consult your dealer. ▶Page 33, 34 |

The air conditioner suddenly stops operating

| Case | Description / what to check |
|-----------------------------|---|
| OPERATION lamp is on. | <ul style="list-style-type: none"> To protect the system, the air conditioner may stop operating after sudden large voltage fluctuations. It automatically resumes operation in about 3 minutes. |
| OPERATION lamp is blinking. | <ul style="list-style-type: none"> Are the air filters dirty? Clean the air filters. Is there anything blocking the air inlet or air outlet of the indoor unit or outdoor unit? Stop operation and after turning off the circuit breaker, remove the obstruction. Then restart operation with the remote controller. If the OPERATION lamp is still blinking, check the error code and consult your dealer. ▶Page 33, 34 Are operation modes all the same for indoor units connected to outdoor units in the multi system? If not, set all indoor units to the same operation mode and confirm that the lamps. Moreover, when the operation mode is in AUTO, set all indoor unit operation modes to COOL or HEAT for a moment and check again that the lamps are normal. If the lamps stop blinking after the above steps, there is no malfunction. ▶Page 18, 19 |

The air conditioner does not stop operating

| Case | Description / what to check |
|--|--|
| The air conditioner continues operating even after operation is stopped. | <ul style="list-style-type: none"> <ul style="list-style-type: none"> Immediately after the air conditioner is stopped <ul style="list-style-type: none"> The outdoor unit fan continues rotating for about another 1 minute to protect the system. While the air conditioner is not in operation <ul style="list-style-type: none"> When the outdoor temperature is high, the outdoor unit fan may start rotating to protect the system. |

Wireless LAN connection

| When this happens | Explanation and where to check |
|---|---|
| The device (air conditioner) cannot be found on the device list screen. | <ul style="list-style-type: none"> Carry out connection setting again while the lamp blinks quickly. Move the router (wireless LAN access point) close to the indoor unit. ▶Page 20-22 There is a possibility that you are using an unsupported smart phone or router (wireless LAN access point). For details, refer to the web site. ▶Page 20-22 |
| Even if the wireless LAN connection adapter lamp is lit, operation from outside the home is not possible. | <ul style="list-style-type: none"> Communication between the router and the internet connection may not be working. Please confirm. |

When the Need Arises

Troubleshooting

The room does not cool down / warm up

| Case | Description / what to check |
|--|--|
| Air does not come out. | <ul style="list-style-type: none"> <input checked="" type="checkbox"/> ■ In HEAT operation <ul style="list-style-type: none"> • The air conditioner is warming up. Wait for about 1 to 4 minutes. • During defrosting operation, hot air does not flow out of the indoor unit. ■ When the air conditioner operates immediately after the circuit breaker is turned on <ul style="list-style-type: none"> • The air conditioner is preparing to operate. Wait for about 3 to 10 minutes. • When the outdoor temperature is below 40°F (5°C) and heating operation is started, the air conditioner is warming up. Wait for about 10 to 25 minutes. |
| Air does not come out / Air comes out. | <ul style="list-style-type: none"> <input type="checkbox"/> ■ Is the airflow rate setting appropriate? <ul style="list-style-type: none"> • Is the airflow rate setting low, such as "Indoor unit quiet" or "Airflow rate 1"? Increase the airflow rate setting. ■ Is the set temperature appropriate? ■ Is the adjustment of the airflow direction appropriate? |
| Air comes out. | <ul style="list-style-type: none"> <input type="checkbox"/> • Is there any furniture directly under or beside the indoor unit? • Is the air conditioner in ECONO operation? ▶ Page 15 • Are the air filters dirty? • Is there anything blocking the air inlet or air outlet of the indoor unit or outdoor unit? • Is a window or door open? • Is an exhaust fan turning? • Depending on the room conditions, number of occupants, or outdoor temperature and humidity, the set temperature may not be reached. <p>A temperature regulation function which factors in living space conditions is available. For further details, please contact your dealer.</p> |

Water or mist comes out

| Case | Description / what to check |
|--|--|
| Mist comes out of the indoor unit. | <ul style="list-style-type: none"> <input checked="" type="checkbox"/> • This happens when the air in the room is cooled into mist by the cold airflow during COOL or other operation. |
| Water is leaking from the indoor unit. | <ul style="list-style-type: none"> <input type="checkbox"/> • If the drain hose is crushed or clogged, water from the indoor unit may be unable to drain and start leaking. Stop operation of the unit immediately and contact your dealer. |

Remote controller

| Case | Description / what to check |
|--|---|
| The unit does not receive signals from the remote controller or has a limited operating range. | <ul style="list-style-type: none"> <input checked="" type="checkbox"/> • The batteries may be exhausted. Replace both batteries with new dry batteries AAA.LR03 (alkaline). For details, refer to "Preparation Before Operation". ▶ Page 9 • Signal communication may be disabled if an electronic-starter-type fluorescent lamp (such as inverter-type lamps) is in the room. Consult your dealer if that is the case. • The remote controller may not function correctly if the transmitter is exposed to direct sunlight. • Is there a device in the room that redirects remote controller signals? Some appliances such as TV speakers are equipped with these devices. If there is such a device in the room, the signals it emits may interfere with signals from the remote controller, preventing reception. • Infrared rays from smartphones and game consoles may interfere with signals from the remote controller, preventing reception. |
| LCD is faint, is not working, or the display is erratic. | <ul style="list-style-type: none"> <input checked="" type="checkbox"/> • The batteries may be exhausted. Replace both batteries with new dry batteries AAA.LR03 (alkaline). For details, refer to "Preparation Before Operation". ▶ Page 9 |
| The LCD is blinking and the remote controller cannot be operated. | <ul style="list-style-type: none"> <input checked="" type="checkbox"/> • Battery power has run out. Replace both batteries at the same time with new size AAA.LR03 (alkaline) batteries. Leaving exhausted batteries in the remote controller can result in injury due to battery leakage, rupturing or heating, or lead to equipment failure. (Even when the LCD is blinking, the OFF button remains functional.) |
| Other electric devices start operating. | <ul style="list-style-type: none"> <input checked="" type="checkbox"/> • If the remote controller activates other electric devices, move them away or consult your dealer. |

When the Need Arises

Air has an odor

| Case | Description / what to check |
|--|--|
| The air conditioner gives off an odor. | <input checked="" type="checkbox"/> • The room odor absorbed in the unit is discharged with the airflow. We recommend you to have the indoor unit cleaned. Please consult your dealer. |
| | <input checked="" type="checkbox"/> • The indoor unit is blowing out room odor it has absorbed (the smell of walls or carpeting, furniture, clothes, and so on). If the air conditioner has been used for a long time, there is a chance that a dirty heat exchanger or fan are emitting an odor. We recommend you to have the indoor unit cleaned. Please consult your dealer. Do not spray the air conditioner unit with any deodorizers. |

Display lamp

| Case | Description / what to check |
|--|---|
| The unit operates even though the OPERATION lamp is off. | <input type="checkbox"/> • Is lamp brightness set to “OFF”? ▶ Page 23 |
| The LED lamps on the unit are dim. | <input type="checkbox"/> • Is lamp brightness set to “L”? ▶ Page 23 |

Others

| Case | Description / what to check |
|--|--|
| The air conditioner suddenly starts behaving strangely during operation. | <input type="checkbox"/> • The air conditioner may malfunction due to lightning or radio. If the air conditioner malfunctions, turn off the power with the circuit breaker and restart the operation with the remote controller. |
| The ceiling and walls around the indoor unit are black and dirty. | <input checked="" type="checkbox"/> • Due to the circulation pattern of the air and static electricity, the air conditioner is causing airborne dirt and dust to stick to walls and other surfaces. Depending on the wallpaper type, dirt may adhere more easily. A thorough cleaning of the area around the air conditioner is recommended. |

Notes on the operating conditions

- If operation continues under any conditions other than those listed in the table,
 - A safety device may activate to stop the operation.
 - Dew may form on the indoor unit and drip from it when COOL or DRY operation is selected.
- *1 Cutting the jumper on the outdoor unit PCB will extend the cooling operation range to 14°F (–10°C).
 Installing an air direction adjustment grille (sold separately) will further extend the operation range to –4°F (–20°C).
 Please consult your dealer.
- *2 Installing a drain pan heater (sold separately) will further extend the heating operation range to –13°F (–25°C).
 Please consult your dealer.

| Mode | Operating conditions |
|------------|--|
| COOL / DRY | Outdoor temperature [RXT models] : 50*1 - 115°F (10*1 - 46°C) [MXM, MXT, MXTH models]: 14 - 115°F (–10 - 46°C) *1 –4°F (–20°C) if an air direction adjustment grille (sold separately) is installed. |
| | Indoor temperature : 64 - 90°F (18 - 32°C) |
| | Indoor humidity : 80% max. |
| HEAT | Outdoor temperature [MXM models] : 5 - 75°F (–15 - 24°C) [RXT, MXT models] : 5*2 - 75°F (–15*2 - 24°C) [MXTH models] : –13 - 75°F (–25 - 24°C) *2 –13°F (–25°C) if a drain pan heater (sold separately) is installed. |
| | Indoor temperature : 50 - 86°F (10 - 30°C) |

When the Need Arises

Troubleshooting

The OPERATION lamp blinks

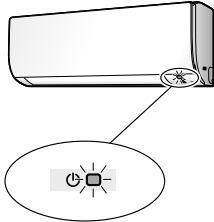

■ Check the interval time between blinks of the OPERATION lamp.

If connecting to multiple indoor units

[Blink interval of about 2 to 3 seconds]

Check the operation mode of any indoor units connected in other rooms.

Because this is a multi system air conditioner, it has one outdoor unit connected to multiple indoor units in different rooms.

If the operation mode is different from the operation mode of the indoor unit in another room, the OPERATION lamp may blink and operation may not be performed, or operation may stop while in progress.

COOL, DRY and HEAT operation may not be used at the same time.

[Blink interval of about 0.5 seconds]

This is a notification of an abnormality.

Check the error code following the procedure below, and respond according to the instructions in the table.



■ Fault diagnosis by remote controller

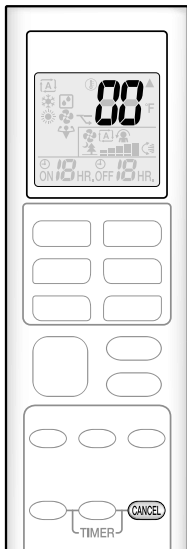

1. When **CANCEL** is held down for about 5 seconds, “00” blinks in the temperature display section.

2. While pointing the remote controller at the indoor unit, press **CANCEL** repeatedly.

A beep indicates a non-corresponding error code.
A long beep indicates a corresponding error code.

3. When a long beep is produced, check the error code and respond according to the instructions in the table.

- To cancel the code display, hold down **CANCEL** for about 5 seconds (the code display also clears if no button is pressed for a while).

| CODE | Cause | Description / what to check |
|---|--|---|
| E7 | The fan of the outdoor unit is stopped. • Is there any foreign matter inside the outdoor unit? | After turning off the circuit breaker, remove the foreign matter, then turn the power on again and operate. |
| L3, L4, L5 | The temperature inside the outdoor unit has become too high, so operation has stopped. • Is there anything blocking the air outlet of the outdoor unit? | After turning off the circuit breaker, remove the obstruction, then turn the power on again and operate. |
| Other error codes, or if the error code cannot be checked | | An abnormality has occurred. |

In the case of error code **U0** or **F3**

When the Need Arises

| | CODE | MEANING |
|---------------------|---|---|
| SYSTEM | 00 | NORMAL |
| | UA | INDOOR-OUTDOOR UNIT COMBINATION FAULT |
| | U0 | REFRIGERANT SHORTAGE |
| | U2 | DROP VOLTAGE OR MAIN CIRCUIT OVERVOLTAGE |
| | U4 | FAILURE OF TRANSMISSION (BETWEEN INDOOR UNIT AND OUTDOOR UNIT) |
| INDOOR UNIT | A1 | INDOOR PCB DEFECTIVENESS |
| | A5 | HIGH PRESSURE CONTROL OR FREEZE-UP PROTECTOR |
| | A6 | FAN MOTOR FAULT |
| | C4 | FAULTY HEAT EXCHANGER TEMPERATURE SENSOR |
| | C9 | FAULTY SUCTION AIR TEMPERATURE SENSOR |
| OUTDOOR UNIT | CC | FAULTY HUMIDITY SENSOR |
| | EA | COOLING-HEATING SWITCHING ERROR |
| | E1 | CIRCUIT BOARD FAULT, ELECTRONIC EXPANSION VALVE COIL DRIVER FAULT |
| | E3* | HIGH PRESSURE SWITCH (HPS) ACTIVATED |
| | E5 | OL (COMPRESSOR OVERLOAD) STARTED, HIGH PRESSURE SWITCH (HPS) ACTIVATED* |
| | E6 | FAULTY COMPRESSOR START UP |
| | E7 | DC FAN MOTOR FAULT |
| | E8 | OVERCURRENT INPUT |
| | E9 | ELECTRONIC EXPANSION VALVE COIL FAULT |
| | F3 | HIGH TEMPERATURE DISCHARGE PIPE CONTROL |
| | F6 | HIGH PRESSURE CONTROL (IN COOLING) |
| | F8 | OPERATION HALT DUE TO COMPRESSOR INTERNAL TEMPERATURE ABNORMALITY |
| | H0 | SENSOR FAULT |
| | H3 | HIGH PRESSURE SENSOR ABNORMALITY |
| | H6 | OPERATION HALT DUE TO FAULTY POSITION DETECTION SENSOR |
| | H7 | FAN IPM TEMPERATURE ERROR |
| | H8 | DC CURRENT SENSOR FAULT |
| | H9 | FAULTY SUCTION AIR TEMPERATURE SENSOR |
| | J3 | FAULTY DISCHARGE PIPE TEMPERATURE SENSOR |
| | J6 | FAULTY HEAT EXCHANGER TEMPERATURE SENSOR |
| L3 | ELECTRICAL PARTS HEAT FAULT | |
| L4 | HIGH TEMPERATURE AT INVERTER CIRCUIT HEATSINK | |
| L5 | OUTPUT OVERCURRENT | |
| P4 | FAULTY INVERTER CIRCUIT HEATSINK TEMPERATURE SENSOR | |

*The contents of the error differ depending on the connected outdoor unit.

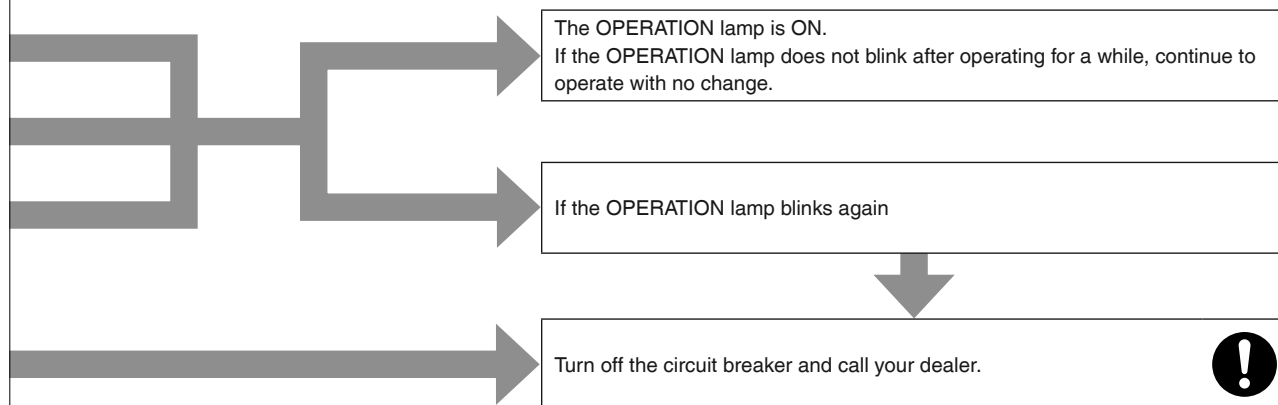

When the Need Arises

Troubleshooting

■ Call your dealer immediately

WARNING

When an abnormality (such as a burning smell) occurs, stop operation and turn off the circuit breaker.

- Continued operation in an abnormal condition may result in problems, electric shock or fire.
- Consult the dealer where you bought the air conditioner.

Do not attempt to repair or modify the air conditioner by yourself.

- Incorrect work may result in electric shock or fire.
- Consult the dealer where you bought the air conditioner.

If one of the following symptoms takes place, call your dealer immediately.

- The power cord is abnormally hot or damaged.
- An abnormal sound is heard during operation.
- The circuit breaker cuts off the operation frequently.
- A switch or a button often fails to work properly.
- There is a burning smell.
- Water leaks from the indoor unit.

Turn off the circuit breaker and call your dealer.



■ After a power failure

- The air conditioner automatically resumes operation in about 3 minutes. Please wait for a while.

■ Lightning

- If there is a risk lightning could strike in the neighborhood, stop operation and turn off the circuit breaker to protect the system.

■ Disposal requirements



- Dismantling of the unit, handling of the refrigerant, oil and other parts, should be done in accordance with the relevant local and national regulations.

2.2 FTXV15/18/24

Read Before Operation

Safety Considerations





Refer also to the General Safety Considerations in the separate booklet.

| | |
|---|--|
|  | Read the precautions in this manual carefully before operating the unit. |
|  | This appliance is filled with R32. |

Read these **Safety Considerations for Operations** carefully before operating an air conditioner or heat pump.

Make sure that the unit operates properly during the startup operation. Instruct the user on how to operate and maintain the unit. Inform users that they should store this operation manual with the installation manual for future reference.

Meanings of **DANGER**, **WARNING**, **CAUTION**, and **NOTE** Symbols:

-  **DANGER** Indicates an imminently hazardous situation which, if not avoided, will result in death or serious injury.
-  **WARNING** Indicates a potentially hazardous situation which, if not avoided, could result in death or serious injury.
-  **CAUTION** Indicates a potentially hazardous situation which, if not avoided, may result in minor or moderate injury. It may also be used to alert against unsafe practices.
-  **NOTE** Indicates situations that may result in equipment or property-damage accidents only.

 **DANGER**

- Do not install the unit in an area where flammable materials are present due to risk of explosion resulting in serious injury or death.
- Any abnormalities in the operation of the air conditioner or heat pump, such as smoke or fire, could result in severe injury or death. Turn off the power and contact your dealer immediately.
- Refrigerant gas may produce toxic gas if it comes into contact with fire, such as from a fan heater, stove, or cooking device. Exposure to this gas could cause severe injury or death.
- For refrigerant leakage, consult your dealer. Refrigerant gas is heavier than air and replaces oxygen. A massive leak could lead to oxygen depletion, especially in basements, and an asphyxiation hazard could occur leading to serious injury or death.
- If equipment utilizing a burner is used in the same room as the air conditioner or heat pump, there is the danger of oxygen deficiency which could lead to an asphyxiation hazard resulting in serious injury or death. Be sure to ventilate the room sufficiently to avoid this hazard.
- Safely dispose of the packing materials. Packing materials, such as nails and other metal or wooden parts, may cause stabs or other injuries.

- Tear apart and throw away plastic packaging bags so that children will not play with them. Children playing with plastic bags face the danger of death by suffocation.

 **WARNING**

- Contact your dealer for repair and maintenance. Improper repair and maintenance may result in water leakage, electric shock, and fire. Only use accessories made by Daikin that are specifically designed for use with the equipment and have them installed by a professional.
- Contact your dealer to move and reinstall the air conditioner or heat pump. Incomplete installation may result in water leakage, electric shock, and fire.
- Never let the indoor unit or the remote controller get wet. Water can cause an electric shock or a fire.
- Never use flammable spray such as hair spray, lacquer, or paint near the unit. Flammable spray may cause a fire.
- When a fuse blows out, never replace it with one of incorrect ampere ratings or different wires. Always replace any blown fuse with a fuse of the same specification.
- Never remove the fan guard of the unit. A fan rotating at high speed without the fan guard is very dangerous.
- Never inspect or service the unit by yourself. Contact a qualified service person to perform this work.
- Turn off all electrical power before doing any maintenance to avoid the risk of serious electric shock; never sprinkle or spill water or liquids on the unit.
- Do not touch the switch with wet fingers. Touching a switch with wet fingers can cause electric shock.
- Do not allow children to play on or around the unit to prevent injury.
- The heat exchanger fins are sharp enough to cut. To avoid injury wear gloves or cover the fins while working around them.
- Do not put a finger or other objects into the air inlet or air outlet. The fan is rotating at high speed and will cause injury.
- Check the unit foundation for damage on a continuous basis, especially if it has been in use for a long time. If left in a damaged condition the unit may fall and cause injury.
- Placing a flower vase or other containers with water or other liquids on the unit could cause a shock or fire if a spill occurs.
- Do not touch the air outlet or horizontal blades while the swing flap is in operation because fingers could get caught and injured.
- Never touch the internal parts of the controller. Do not remove the front panel because some parts inside are dangerous to touch. To check and adjust internal parts, contact your dealer.
- Do not use means to accelerate the defrosting process or to clean, other than those recommended by the manufacturer.
- The appliance must be stored in a room without continuously operating ignition sources (for example: open flames, an operating gas appliance or an operating electric heater).
- Do not pierce or burn.
- Be aware that refrigerants may not contain an odor.

Read Before Operation

CAUTION

- Do not use the air conditioner or heat pump for any other purposes other than comfort cooling or heating. Do not use the unit for cooling precision instruments, food, plants, animals or works of art.
- Do not place items under the indoor unit as they may be damaged by condensates that may form if the humidity is above 80% or if the drain outlet gets blocked.
- Before cleaning, stop the operation of the unit by turning the power off or by pulling the supply cord out from its receptacle. Otherwise, an electric shock and injury may result.
- Do not wash the air conditioner or heat pump with excessive water. An electric shock or fire may result.
- Avoid placing the controller in a spot which may be splashed with water. Water entering the controller may cause an electric shock or damage the internal electronic parts.
- Do not operate the air conditioner or heat pump when using a room-fumigation type of insecticide. Failure to observe this could cause the chemicals to be deposited in the unit and can endanger the health of those who are hypersensitive to chemicals.
- Do not turn off the power immediately after stopping operation. Always wait for at least 5 minutes before turning off the power. Otherwise, water leakage may occur.
- The appliance is not intended for use by young children or infirm persons without supervision.
- The remote controller should be kept away from children so they cannot play with it.
- Consult with the installation contractor for cleaning.
- Incorrect cleaning of the inside of the air conditioner or heat pump could make the plastics parts break and cause water leakage or electric shock.
- Do not touch the air inlet or aluminum fin of the air conditioner or heat pump as they can cut and cause injury.
- Do not place objects in direct proximity of the outdoor unit. Do not let leaves and other debris accumulate around the unit. Leaves are a hotbed for small animals which can enter the unit. Once inside the unit, animals can cause the unit to malfunction, and cause smoke or fire when they make contact with electrical parts.

NOTE

- Never press the button of the remote controller with a hard, pointed object. The remote controller may be damaged.
- Never pull or twist the electric wire of the remote controller. It may cause the unit to malfunction.
- Do not place appliances that produce open flames in places that are exposed to the airflow of the unit or under the indoor unit. It may cause incomplete combustion or deformation of the unit due to the heat.
- Do not expose the controller to direct sunlight. The LCD display can become discolored and may fail to display the data.

- Do not wipe the controller operation panel with benzene, thinner, chemical dust cloth, etc. The panel may get discolored or the coating can peel off. If it is heavily dirty, soak a cloth in water-diluted neutral detergent, squeeze it well and wipe the panel clean. Then wipe it with another dry cloth.
- Dismantling of the unit, disposal of the refrigerant, oil, and additional parts, should be done in accordance with the relevant local, state, and national regulations.
- Operate the air conditioner or heat pump in a sufficiently ventilated area and not surrounded by obstacles. Do not use the air conditioner or heat pump in the following places.
 - a. Places with a mist of mineral oil, such as cutting oil.
 - b. Locations such as coastal areas where there is a lot of salt in the air.
 - c. Locations such as hot springs where there is a lot of sulfur in the air.
 - d. Locations such as factories where the power voltage varies a lot.
 - e. In cars, boats, and other vehicles.
 - f. Locations such as kitchens where oil may splatter or where there is steam in the air.
 - g. Locations where equipment produces electromagnetic waves.
 - h. Places with an acid or alkaline mist.
 - i. Places where fallen leaves can accumulate or where weeds can grow.
- Take snow protection measures. Contact your dealer for the details of snow protection measures, such as the use of a snow protection hood.
- Do not attempt to do electrical work or grounding work unless you are licensed to do so. Consult with your dealer for electrical work and grounding work.
- Pay attention to operating sound. Be sure to use the following places:
 - a. Places that can sufficiently withstand the weight of the air conditioner or heat pump yet can suppress the operating sound and vibration.
 - b. Places where warm air from the air outlet of the outdoor unit or the operating sound of the outdoor unit does not annoy neighbors.
- Make sure that there are no obstacles close to the outdoor unit. Obstacles close to the outdoor unit may drop the performance of the outdoor unit or increase the operating sound of the outdoor unit.
- Consult your dealer if the air conditioner or heat pump in operation generates unusual noise.
- Make sure that the drainpipe is installed properly to drain water. If no water is discharged from the drainpipe while the air conditioner or heat pump is in the cooling mode, the drainpipe may be clogged with dust or dirt and water leakage from the indoor unit may occur. Stop operating the air conditioner or heat pump and contact your dealer.
- Do not spray the air conditioner unit with any deodorizers, etc. It may cause the unit to malfunction.

FTP002(R32)-U

Read Before Operation

Names of Parts

Indoor Unit

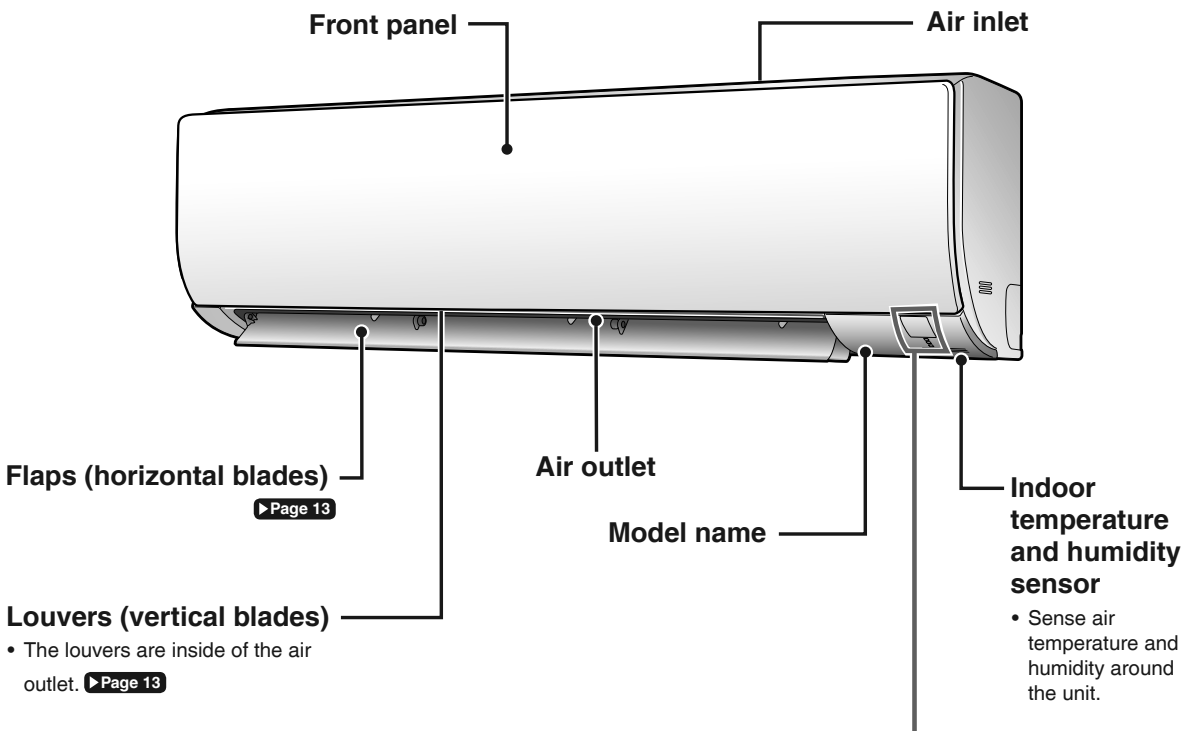

Display

Signal receiver

- Receives signals from the remote controller.
- When the unit receives a signal, you will hear a beep sound.

| Case | Sound type |
|-----------------|------------|
| Operation start | beep-beep |
| Setting changed | beep |
| Operation stop | long beep |

OPERATION lamp (Green)
▶Page 10

TIMER lamp (Orange)
▶Page 16, 17

Wireless LAN connection adapter lamp (Orange)
▶Page 8, 21, 22

Indoor unit ON/OFF switch

- Press this switch once to start operation. Press once again to stop it.
- For the operation mode setting, refer to the following table.

| Mode | Temperature setting | Airflow rate |
|------|---------------------|--------------|
| AUTO | 77°F (25°C) | AUTO |

- This switch can be used when the remote controller is missing or out of batteries.

Read Before Operation

■ **Open the front panel**

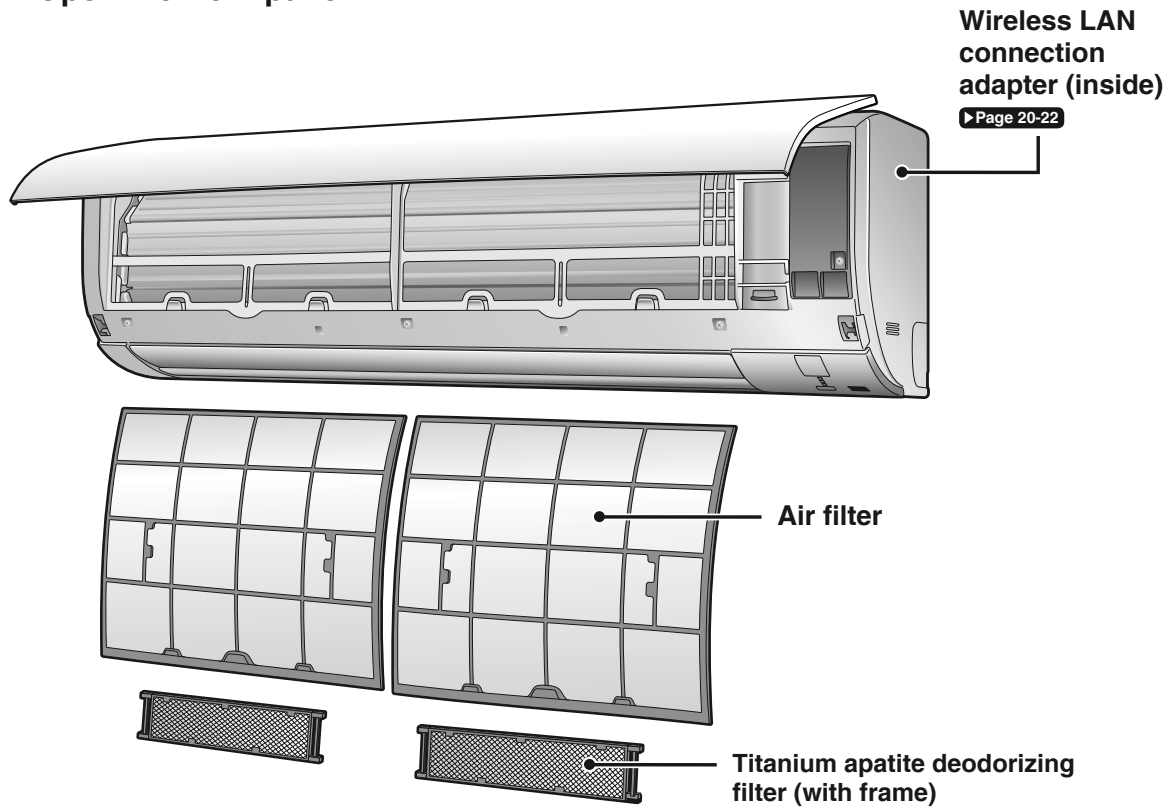

Outdoor Unit

• The appearance of the outdoor unit may differ between different models.

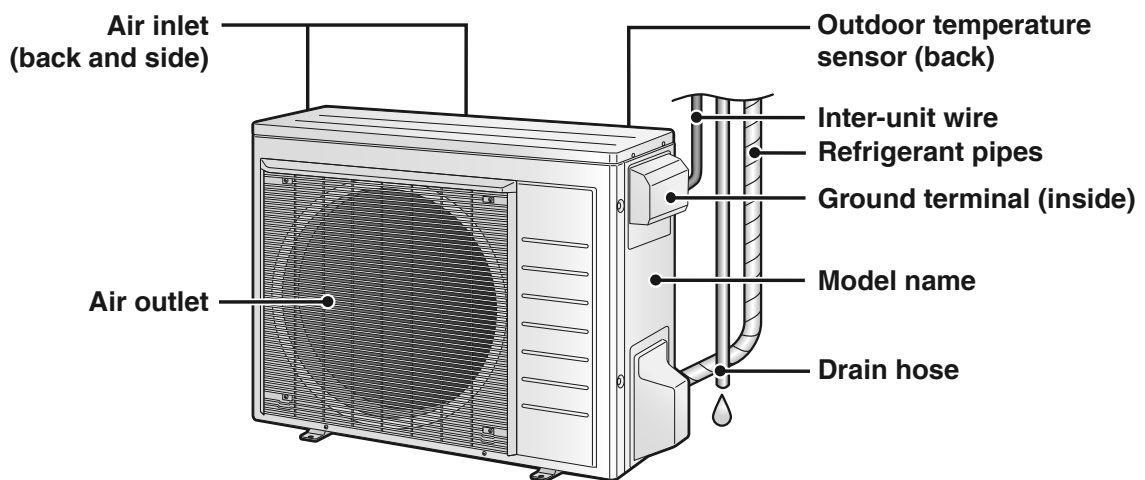

Read Before Operation

Names of Parts

Remote Controller

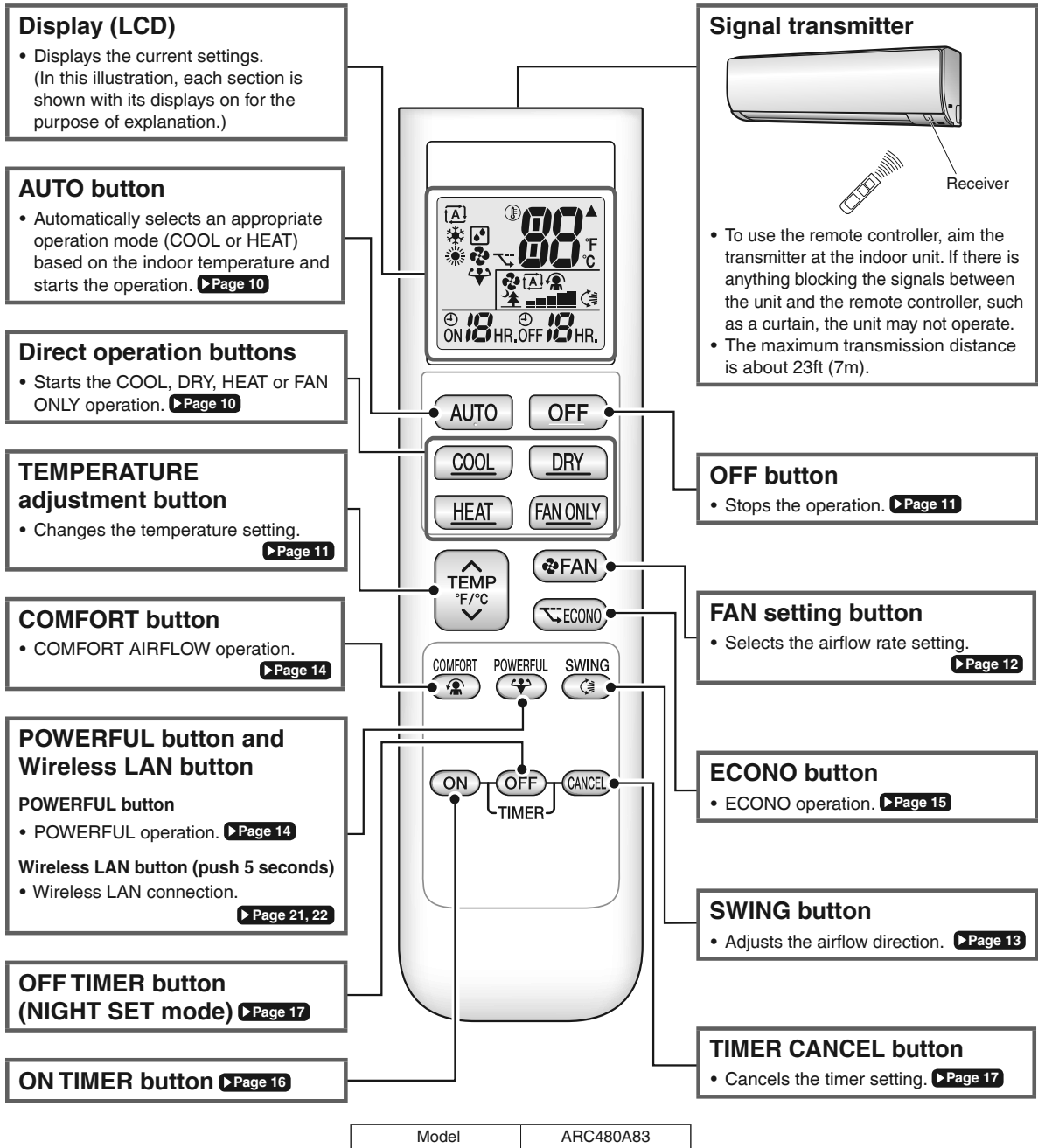

Read Before Operation

Wireless LAN connection adapter

The Wireless LAN connection adapter function requires the Daikin One Home for connecting to the air conditioner and controlling it via your smartphone or tablet over your network.

Attention

- **Wireless LAN sends and receives data using radio waves so there is a risk of transmitted data being subject to eavesdropping and illegal access.** When using wireless LAN, manage the SSID/KEY of the wireless LAN connection adapter, the SSID/KEY of the wireless router, and the app login information so that they will not be known to others, and ensure that you have an adequate understanding of the risks involved. [▶ Page 6](#)
In the case that the product is accessed and operated illegally, turn off the wireless LAN connection adapter function. [▶ Page 22](#)
- **Do not use this product near a microwave oven. (This can affect wireless LAN communications.)**
- **This product cannot be directly connected to the communication line of a telecommunications carrier (internet service provider, etc.). When connecting to the internet, be sure to connect via a device such as a router.**
 When the wireless LAN connection adapter function is turned on, the right side of the air conditioner may become slightly warm, but this is not an abnormality.

⚠ WARNING

- While the Wireless LAN connection adapter operates, it may affect persons using cardiac pacemakers or defibrillators. This product may cause electromagnetic interference.
- While the Wireless LAN connection adapter operates, it may affect automatic doors or fire alarm equipment. This product may cause faulty behavior of the equipment.

Configuration

- The user is responsible for providing the following items before using this product:
 - Smartphone or tablet PC
 - Internet line and communicating device (Modem/router or similar device)
 - Wireless LAN access point
 - Application name: [Daikin One Home] (free)
 For details on the installation method for the Daikin One Home, please see [▶ Page 21](#).

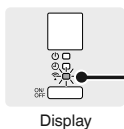

Wireless LAN connection adapter lamp (Orange)

- The Wireless LAN connection adapter lamp lights when connecting to a router (Wireless LAN access point). Please see [▶ Page 21](#).
- For Wireless LAN connection adapter operation, please see [▶ Page 22](#).

⚠ WARNING

When operating an air conditioner from outside the home, it is not possible to check the air conditioner or the surroundings of the air conditioner, or the state of the people in the room. Therefore, make sure to adequately check for safety before use. In some cases, there is a risk of death, severe injury, or property damage.

- **Check the following in advance (while at home)**
 - Timer settings or reservations that other users may have made. (There is a risk of causing harm to the health of people, animals, or plants in the home if operation starts and stops unexpectedly)
 - There are no signs of abnormality in the air conditioning. Harm will not be caused to people or to the room if there is a change in airflow. (For example, that there are no objects nearby that might blow over) (There is a risk of objects falling due to airflow and causing fire, bodily injury, or staining of household items)
- **Check the following before/while operating a unit from outside the home**
 - If you know that there is someone at home, inform the person when turning the air conditioner on or off from outside the home. (If someone at home is standing on something such as a stool, the air conditioner turning on or off unexpectedly could surprise them and cause them to fall or topple over. Additionally, a sudden change in the indoor/outdoor temperature could harm the health of people at home)
 - The air conditioner can be turned off and temperature adjustment can be made using a remote controller in the home.
 - Do not use the function if the only people at home are persons who are unable to make adjustments to temperature or other settings themselves, such as young children, disabled persons, or elderly persons.
 - Regularly check the settings and operating status of the air conditioner. (Sudden changes in indoor/outdoor temperature pose a health hazard. There is a risk of harm to animals and plants)
 If an error occurs during operation, immediately turn off the air conditioner and contact your dealer.
 Double check the display to confirm that the power is off.

Read Before Operation

Preparation Before Operation

CAUTION

Incorrect handling of batteries can result in injury from battery leakage, rupturing or heating, or lead to equipment failure.

Please observe the following precautions and use safely.

- If the alkaline solution from the batteries should get in the eyes, do not rub the eyes. Instead, immediately flush the eyes with tap water and seek the attention of a medical professional.
- Keep batteries out of reach of children. In the event that batteries are swallowed, seek the immediate attention of a medical professional.
- Do not expose batteries to heat or fire. Do not disassemble or modify batteries. The insulation or gas release vent inside the battery may be damaged, resulting in battery leakage, rupturing, or heating.
- Do not damage or peel off labels on the batteries.

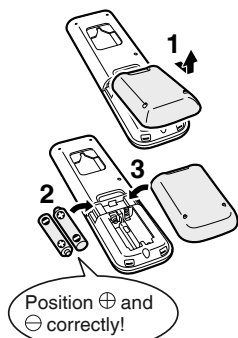

To insert the batteries

1. Remove the back cover by sliding and then slightly lifting it.
2. Insert 2 dry batteries AAA.LR03 (alkaline).
3. Replace the back cover.

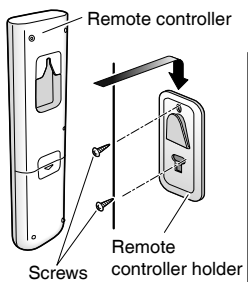

To attach the remote controller holder to a wall

1. Choose a place where the signals reach the unit.
2. Attach the holder to a wall, a pillar, or similar location with the screws supplied with the holder.
3. Hang the remote controller on the remote controller holder.

Fahrenheit/Celsius display switch

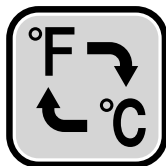

Press  and  (TIMER button) simultaneously for about 5 seconds.

- The temperature will be displayed in Celsius when it is presently displayed in Fahrenheit, and vice versa.
- The switch operation is only possible when the temperature is being displayed.
- A reception sound will go off for the transmission of set temperature to the indoor unit at the time of setting the Fahrenheit/Celsius display change function.

Turn on the circuit breaker

- After the power is turned on, the flap of the indoor unit opens and closes once to set the reference position.

NOTE

Notes on batteries

- To avoid possible injury or damage from battery leakage or rupturing, remove the batteries when not using the product for long periods of time.
- The standard replacement time is about 1 year. Both batteries should be replaced at the same time. Be sure to replace them with new dry batteries AAA.LR03 (alkaline).
- If the remote controller display begins to fade and signal reception begins to decline, replace the batteries with new batteries. Owing to usage conditions, battery consumption may be accelerated.
- The batteries supplied with the remote controller are for initial operation. The batteries may run out in less than 1 year.

Notes on remote controller

- Do not drop the remote controller. Do not get it wet.
- If dirt becomes an issue, wipe with a soft dry cloth.

Fahrenheit/Celsius display change function of remote controller

- The set temperature may increase when the display is changed to Celsius from Fahrenheit, because a fraction of 0.5°C is rounded up.
- Example: A set temperature of 65°F (equivalent to 18.5°C) will be converted into 19°C.

When the display is changed to Fahrenheit again, the set temperature will be converted into 66°F (equivalent to 19°C) instead of the original set temperature (65°F) but a set temperature of 66°F (equivalent to 19°C) will be converted into 19°C with no temperature change.

Basic Operation



AUTO · COOL · DRY · HEAT · FAN ONLY Operation

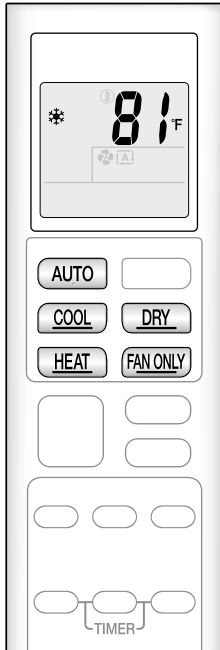

The air conditioner operates with the operation mode of your choice.

To start operation

AUTO operation

- To automatically select an appropriate temperature and operation mode.

Press **AUTO** .



COOL operation

- To lower the temperature.

Press **COOL** .



DRY operation

- To lower the humidity.

Press **DRY** .



HEAT operation

- To raise the temperature.

Press **HEAT** .



FAN ONLY operation

- To circulate air in the room.

Press **FAN ONLY** .



- The OPERATION lamp lights green.

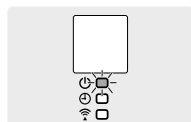

Display

NOTE

Notes on AUTO operation

- In AUTO operation, the system selects an appropriate operation mode (COOL or HEAT) based on the indoor temperature and starts the operation.
- The system automatically reselects setting at a regular interval to bring the indoor temperature to the user-setting level.

Note on DRY operation

- Eliminates humidity while maintaining the indoor temperature as much as possible. It automatically controls temperature and airflow rate, so manual adjustment of these functions is unavailable.

Basic Operation



AUTO · COOL · DRY · HEAT · FAN ONLY Operation

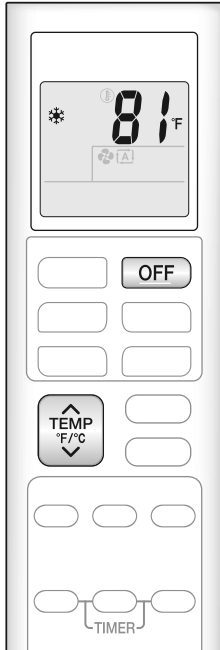

To stop operation

Press **OFF** .

- The OPERATION lamp goes off.

To change the temperature setting

Press **TEMP** .

- Press **▲** to raise the temperature and press **▼** to lower the temperature.

| COOL operation | HEAT operation | AUTO operation | DRY or FAN ONLY operation |
|----------------------|----------------------|----------------------|--|
| 64-90°F (18-32°C) | 50-86°F (10-30°C) | 64-86°F (18-30°C) | The temperature setting cannot be changed. |

Tips for saving energy

Keeping the temperature setting at a moderate level helps save energy.

- Recommended temperature setting
 - For cooling: 78-82°F (26-28°C)
 - For heating: 68-75°F (20-24°C)

Cover windows with a blind or a curtain.

- Blocking sunlight and air from outdoors increases the cooling (heating) effect.

Keep the air filters clean.

- Clogged air filters cause inefficient operation and waste energy. Clean them once in about every 2 weeks. [▶ Page 26](#)

If you are not going to use the air conditioner for a long period, for example in spring or autumn, turn off the circuit breaker.

- The air conditioner always consumes a small amount of electricity even while it is not operating.



Basic Operation



Adjusting the Airflow Rate

You can adjust the airflow rate to increase your comfort.

To adjust the airflow rate setting

▶ Press **FAN** .

- Each pressing of **FAN** changes the airflow rate setting in sequence.

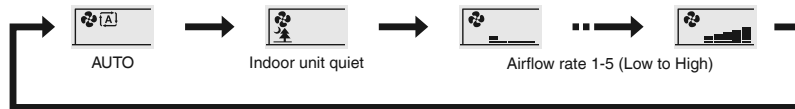

- When the airflow is set to “”, quiet operation starts and noise from the indoor unit will become quieter. However, it may become difficult to cool (or warm) the room.
- In the quiet operation mode, the airflow rate is set to a weak level.

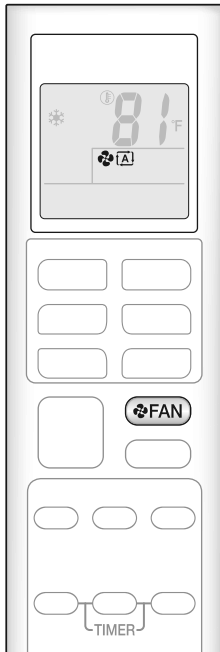

| AUTO, COOL, HEAT and FAN ONLY operation | | | | DRY operation | |
|---|--|--|---|---------------|---|
| | | | → | | The airflow rate setting cannot be changed. (only AUTO) |
| | | | | AUTO | |

NOTE

Note on airflow rate setting

- At smaller airflow rates, the cooling (heating) effect is also smaller.

Note on AUTO airflow rate

- When using AUTO airflow rate, the airflow rate is adjusted according to conditions in the room.

Basic Operation



Adjusting the Airflow Direction

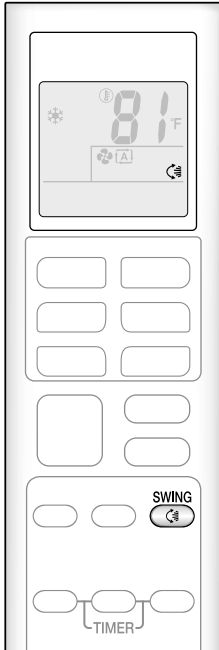

You can adjust the airflow direction to increase your comfort.

⚠ CAUTION

- Always use a remote controller to adjust the angles of the flap. Moving the flap forcibly by hand may cause a malfunction.
- Be careful when adjusting the louvers. Inside the air outlet, a fan is rotating at a high speed.

To start auto swing

Up and down airflow direction

Press  .

- “” is displayed on the LCD.
- The flap (horizontal blade) will begin to swing.

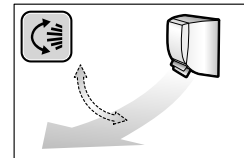

To set the flap at the desired position

- This function is effective while the flap is in auto swing mode.

Press  when the flap reaches the desired position.

- “” disappears from the LCD.

To adjust the louvers at desired position

Hold the knobs and move the louvers (vertical blades).

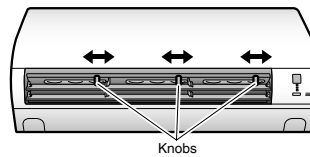

NOTE

Notes on airflow direction setting

- The movable range of the flap varies according to the operation mode.
- If the airflow rate becomes weak during operation, the flap will stop.
When up and down airflow direction is set, the flap will stop in an upward position.

Movable range of the flap

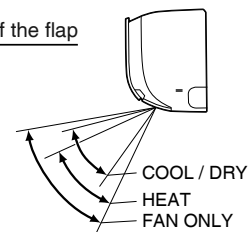

Useful Functions



COMFORT AIRFLOW Operation

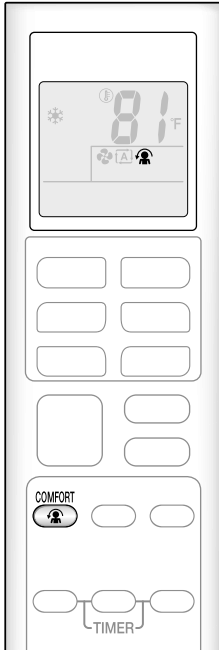

The flow of air will be in the upward direction while in COOL and DRY operation and in the downward direction while in HEAT operation, which will provide a comfortable airflow that will not come in direct contact with people.

To start COMFORT AIRFLOW operation

Press  .

- “” is displayed on the LCD.

| | COOL and DRY operation | HEAT operation | FAN operation |
|----------------|------------------------|----------------|---------------|
| Flap direction | Goes up | Goes down | Not available |
| Airflow rate | AUTO | | |

- When in AUTO operation, the flap direction differs based on the operation mode (COOL or HEAT) as shown in the table above.

To cancel COMFORT AIRFLOW operation

Press  again.

- “” disappears from the LCD.
- The flap will return to the memory position from before COMFORT AIRFLOW operation.



POWERFUL Operation

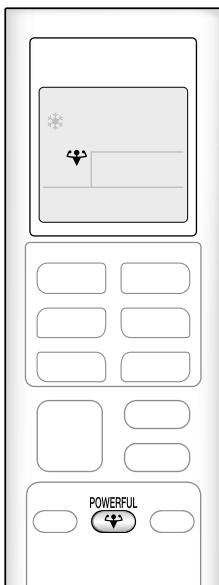

POWERFUL operation quickly maximizes the cooling (heating) effect in any operation mode. In this mode, the air conditioner operates at maximum capacity.

To start POWERFUL operation

Press  .

- “” is displayed on the LCD.
- POWERFUL operation ends in 20 minutes. Then the system automatically operates again with the previous settings which were used before POWERFUL operation.

To cancel POWERFUL operation

Press  again.

- “” disappears from the LCD.

Useful Functions



ECONO Operation

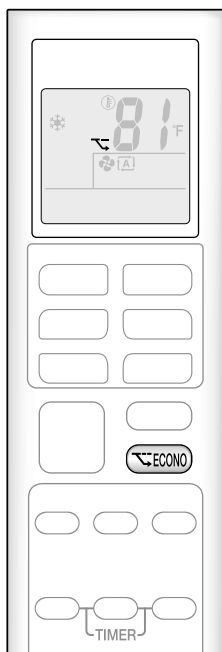

ECONO operation enables efficient operation by limiting the maximum power consumption.

This function is useful to prevent the circuit breaker from tripping when the unit operates alongside other appliances on the same circuit.

To start ECONO operation

Press .

- “” is displayed on the LCD.
- Not available in FAN ONLY mode.

To cancel ECONO operation

Press again.

- “” disappears from the LCD.

NOTE

Notes on COMFORT AIRFLOW operation

- The airflow rate will be set to AUTO.
- If the up and down airflow direction is selected, the COMFORT AIRFLOW operation will be canceled.

Notes on POWERFUL operation

- Pressing causes the settings to be canceled, and “” disappears from the LCD.
- POWERFUL operation will not increase the capacity of the air conditioner if the air conditioner is already in operation with its maximum capacity demonstrated.

- In COOL, HEAT and AUTO operation

To maximize the cooling (heating) effect, the capacity of outdoor unit increases and the airflow rate becomes fixed at the maximum setting.

The temperature and airflow settings cannot be changed in COOL and HEAT operation.

Airflow settings cannot be changed in AUTO operation.

- In DRY operation

The temperature setting is lowered by 1.8°F (1.0°C) and the airflow rate is slightly increased.

- In FAN ONLY operation

The airflow rate is fixed at the maximum setting.

Notes on ECONO operation

- This operation is performed with lower power and therefore may not provide a sufficient cooling (heating) effect.
- Pressing causes the settings to be canceled, and “” disappears from the LCD.
- If the power consumption level is already low, switching to ECONO operation will not reduce the power consumption.

Some useful functions can be used together.

| | |
|----------------------------|----------------|
| COMFORT AIRFLOW + ECONO | Available |
| POWERFUL + COMFORT AIRFLOW | Not available* |
| POWERFUL + ECONO | Not available* |

*Priority is given to the function of whichever button is pressed last.

TIMER Operation



ON/OFF TIMER Operation

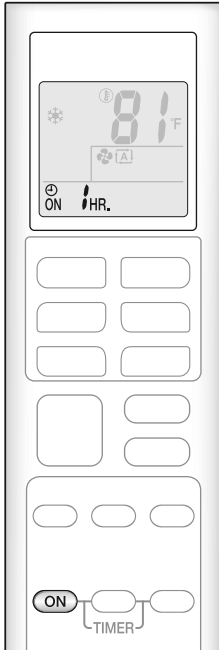

Timer functions are useful for automatically switching the air conditioner on or off in the morning or at night. You can also use the ON TIMER and OFF TIMER together.

To use ON TIMER operation

▶ Press **ON** .

- Each pressing of **ON** changes the time setting by 1 hour. The time can be set between 1 and 12 hours.
- The TIMER lamp lights orange.

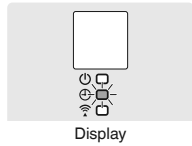

NOTE

In the following cases, set the timer again.

- After the circuit breaker has turned off.
- After a power failure.
- After replacing the batteries in the remote controller.

TIMER Operation



ON/OFF TIMER Operation

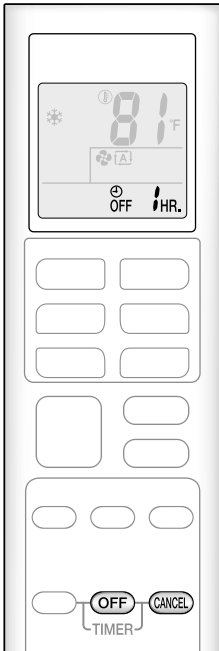

To use OFF TIMER operation

Press **OFF** .

- Each pressing of **OFF** changes the time setting by 1 hour. The time can be set between 1 and 12 hours.
- The TIMER lamp lights orange.

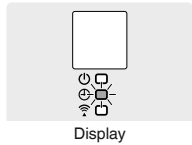

To cancel ON/OFF TIMER operation

Press **CANCEL** .

To combine ON TIMER and OFF TIMER operation

- A sample setting for combining the 2 timers is shown below.
- "ON" and "OFF" are displayed on the LCD.

[Example]

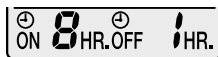

When setting while the unit is operating

- Stops the unit 1 hour later and starts it 7 hours after that.

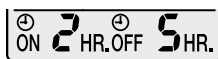

When setting while the unit is stopped

- Starts the unit 2 hours later and stops it 3 hours after that.

NOTE

NIGHT SET mode

- When the OFF TIMER is set, the air conditioner automatically adjusts the temperature setting (0.9°F (0.5°C) up in COOL, 3.6°F (2.0°C) down in HEAT) to prevent excessive cooling (heating) during sleeping hours.

Note for Multi System

A multi system has one outdoor unit connected to multiple indoor units.

Selecting the operation mode

When the priority room setting is active but the set unit is not operating or when the priority room setting is inactive

When more than one indoor unit is operating, priority is given to the first unit that was turned on.

In this case, set the units that are turned on later to the same operation mode as the first unit.

Otherwise, they will enter the standby state, and the OPERATION lamp will blink; this does not indicate malfunction.

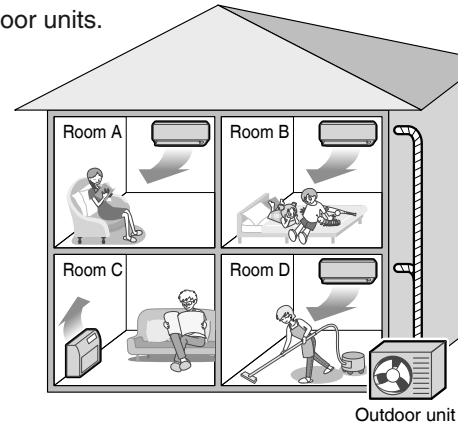

NOTE

Notes on operation mode for a multi system

- COOL, DRY and FAN operation may be used at the same time.
- AUTO operation automatically selects COOL operation or HEAT operation based on the indoor temperature. Therefore, AUTO operation is available when selecting the same operation mode as that of the room with the first unit to be turned on.

CAUTION

- Normally, the operation mode in the room where the unit is first started is given priority, but the following situations are exceptions to this rule. If the operation mode of the first room is FAN operation, then using HEAT operation in any room after this will give priority to HEAT operation. In this situation, the indoor unit operating in FAN mode will switch to standby, and the OPERATION lamp will blink.

With the priority room setting active

Refer to "Priority room setting" on the next page.

Multi Connection

Note for Multi System

COOL/HEAT mode lock

The COOL/HEAT mode lock requires initial programming during installation. Please consult your authorized dealer for assistance. The COOL/HEAT mode lock sets the unit forcibly to either COOL or HEAT operation. This function is convenient when you wish to set all indoor units connected to the multi system to the same operation mode.

NOTE

- The COOL/HEAT mode lock cannot be activated together with the priority room setting.

Priority room setting (Not available on some models)

The priority room setting requires initial programming during installation. Please consult your authorized dealer for assistance. The room designated as the priority room takes priority in the following situations.

Operation mode priority

- As the operation mode of the priority room takes precedence, you can select a different operation mode from other rooms.

[Example]

- Room A is the priority room in this example.
When COOL operation is selected in room A while operating the following modes in room B, C and D:

| Operation mode in room B, C and D | Status of room B, C and D when the unit in room A is in COOL operation |
|-----------------------------------|---|
| COOL or DRY or FAN | The current operation mode is maintained. |
| HEAT | The unit enters the standby mode. Operation resumes when the room A unit stops operating. |
| AUTO | If the unit is set to COOL operation, it continues. If the unit is set to HEAT operation, it enters the standby mode. Operation resumes when the room A unit stops operating. |

Priority when POWERFUL operation is used

[Example]

- Room A is the priority room in this example.
The indoor units in rooms A, B, C and D are all operating. If the unit in room A enters POWERFUL operation, operation capacity will be concentrated in room A. In such a case, the cooling (heating) efficiency of the units in room B, C and D may be slightly reduced.



Wireless LAN connection

Wireless LAN connection



Web site: <https://daikinone.com/ductless>

For instructions on how to connect your unit to wireless LAN and to your Daikin One Home application, please see the website above.

Contains FCC ID: VPYLB1YA

This device complies with part 15 of the FCC Rules. Operation is subject to the following two conditions:

- (1) This device may not cause harmful interference, and
- (2) This device must accept any interference received, including interference that may cause undesired operation.

FCC CAUTION

Changes or modifications not expressly approved by the party responsible for compliance could void the user's authority to operate the equipment.

This transmitter must not be co-located or operated in conjunction with any other antenna or transmitter.

Contains IC: 772C-LB1YA

This device complies with Industry Canada's applicable licence-exempt RSSs.

Operation is subject to the following two conditions:

- (1) This device may not cause interference; and
- (2) This device must accept any interference, including interference that may cause undesired operation of the device.

This equipment complies with IC radiation exposure limits set forth for an uncontrolled environment and meets RSS-102 of the IC radio frequency (RF)

Exposure rules. This equipment should be installed and operated keeping the radiator at least 7-7/8 inches (20cm) or more away from person's body.

The FCC responsible party is Daikin Comfort Technologies Manufacturing, L.P., and may be contacted by calling (713)-861-2500, or at 19001

Kermier Rd., Waller, TX 77484.

(<https://www.northamerica-daikin.com>)

This device, which was assembled by Daikin Comfort Technologies Manufacturing, L.P., contains a component that is classified as an intentional radiator.

This intentional radiator has been certified by the FCC: FCC ID VPYLB1YA.

And this intentional radiator has an industry Canada ID: IC 772C-LB1YA.

The manufacturer of the intentional radiator (model no. Type1YA) is Murata Manufacturing co., Ltd (www.murata.com).

This equipment complies with FCC radiation exposure limits set forth for an uncontrolled environment and meets the FCC radio frequency (RF) Exposure Guidelines. This equipment should be installed and operated keeping the radiator at least 7-7/8 inches (20cm) or more away from person's body.

Changes or modifications not expressly approved by the party responsible for compliance could void the user's authority to operate the equipment.

NOTE: This equipment has been tested and found to comply with the limits for a Class B digital device, pursuant to part 15 of the FCC Rules. These limits are designed to provide reasonable protection against harmful interference in a residential installation. This equipment generates, uses and can radiate radio frequency energy and, if not installed and used in accordance with the instructions, may cause harmful interference to radio communications. However, there is no guarantee that interference will not occur in a particular installation. If this equipment does cause harmful interference to radio or television reception, which can be determined by turning the equipment off and on, the user is encouraged to try to correct the interference by one or more of the following measures:

- Reorient or relocate the receiving antenna.
- Increase the separation between the equipment and receiver.
- Connect the equipment into an outlet on a circuit different from that to which the receiver is connected.
- Consult the dealer or an experienced radio/TV technician for help.

Mobile Controller



Wireless LAN connection

Application software installation

For Android Phones

- 1) Open [Google Play].
- 2) Search using the application name: [Daikin One Home].
- 3) Follow the directions on the screen to install.

For iOS Phones

- 1) Open the [App Store].
- 2) Search using the application name: [Daikin One Home].
- 3) Follow the directions on the screen to install.

Attention

- The actual application screen layout and content may differ from what is shown. The layout and content of the application screen is subject to change without notice.

Connect the air conditioner to your home network.

1. While operation is stopped, press  and hold the button for 5 seconds.

2. Press  or  and select menu number **3.**

- "SP" appears on the LCD.
- "3" blinks.

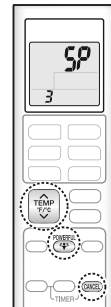

3. Press  to connect to the access point.

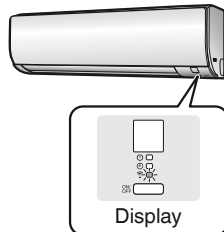

The wireless LAN connection adapter lamp blinks quickly.



4. Press  to return to the default screen.

No more settings need to be carried out from the remote controller.

5. Open Daikin One Home App and follow the instructions to set up the wireless LAN.

6. When the wireless LAN connection adapter lamp switches from blinking to lit, the connection is complete.

NOTE

- While "SP" is displayed, the options that can be selected using  and  are 1, 3, A, and OFF.
- Perform wireless LAN connection one indoor unit at a time.
- If you are unable to establish a network connection, refer the troubleshooting provided by the Daikin One Home App.
- When the lamp blinks slowly, the connection is not ready. Perform the connection procedure while it blinks quickly.

Mobile Controller

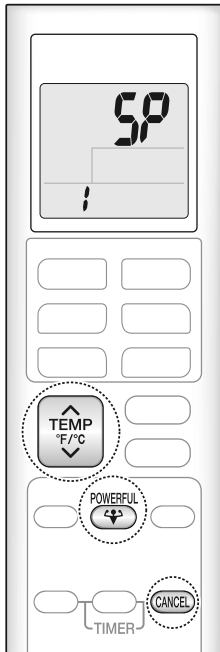

To confirm the wireless LAN connection adapter connection

■ To confirm

1. While operation is stopped, press and hold the button for 5 seconds.
2. Press to confirm the selected setting.

- “SP” appears on the LCD.
- “!” blinks.



Check the indoor unit LED.

| Wireless LAN connection adapter lamp | Status |
|--------------------------------------|---|
| Blinking for 1 second | Connection is not ready |
| Blinking for 3 seconds | Please initialize the wireless LAN connection adapter |
| Does not blink or light | Communication is abnormal There is a possibility of equipment failure Please request repair |

To turn off the wireless connection

■ To use the remote controller

1. While operation is stopped, press and hold the button for 5 seconds.
2. Press or and select menu OFF.

- “SP” appears on the LCD.
- “OFF” blinks, and communication is OFF.

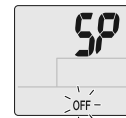

3. Press and hold the button for 2 seconds to confirm selected setting.
 - The wireless LAN connection adapter lamp turn off.
4. Press to return to the default screen.

To reset the connection setting to the factory default

- If you want to reset the connection settings, it is possible to initialize the wireless LAN connection adapter to its factory default state. If initialized, data including the network settings and power consumption history will be erased.
- When discarding or transferring to another user, initialize the connection adapter to erase the internal data.

■ To reset

1. While operation is stopped, press and hold the button for 5 seconds.

2. Press or and select menu R.

- “SP” appears on the LCD.
- “R” blinks.

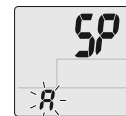

3. Press and hold the button for 2 seconds to confirm selected setting.
 - The wireless LAN connection adapter lamp blinks for 1 second.
4. Press to return to the default screen.

Making Changes to Default Settings

Brightness of Indoor Unit LED Lamps

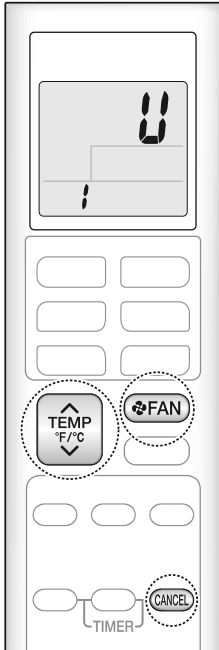

Changes can be made to the setting for the brightness of the LED lamps, to suit your preferences.

1. While operation is stopped, press **FAN** and hold the button for 5 seconds.

2. Press **TEMP F/C** and select menu number **!**.

- “**!**” appears on the LCD.
- “**!**” blinks.

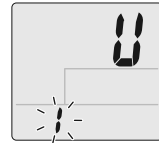

3. Press **FAN**.

4. Press **TEMP F/C** or **TEMP F/C** and select setting option.

- The setting option will blink.

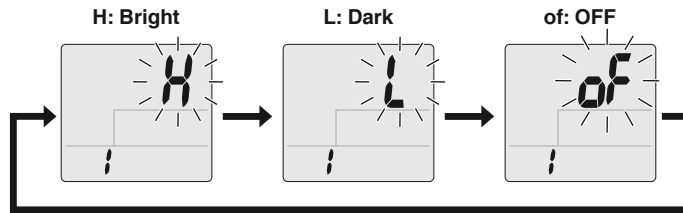

5. Press **FAN**.

6. Press **FAN** and hold the button for 5 seconds to return to the default screen.

NOTE

- Press **CANCEL** to return to the previous screen.
- If no operations are performed for approximately 1 minute, the display will return to the default screen.
- Indoor unit default setting: H (Bright)

Making Changes to Default Settings

Airflow Setting When Indoor Unit Reaches Setpoint

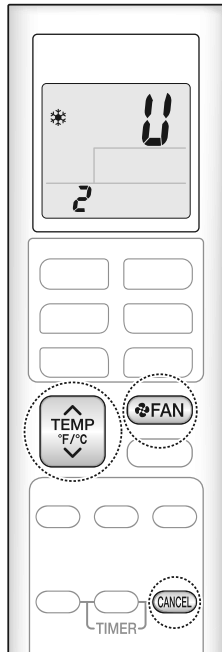

Changes can be made to the setting for airflow rate when unit reaches desired temperature (setpoint), to suit your preferences. This function is effective when COOL operation is selected.

1. While operation is stopped, press **FAN** and hold the button for 5 seconds.

2. Press **TEMP F/C** or **TEMP F/C** and select menu number **2**.

- “U” appears on the LCD.
- “2” blinks.

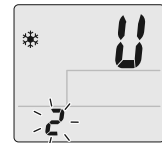

3. Press **FAN**.

4. Press **TEMP F/C** or **TEMP F/C** and select setting option.

- The setting option will blink.

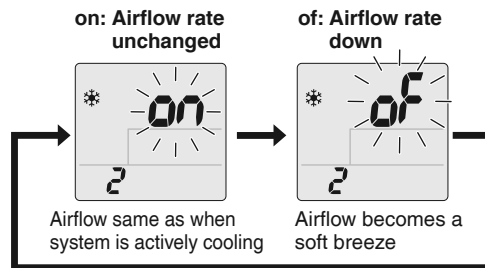

5. Press **FAN**.

6. Press **FAN** and hold the button for 5 seconds to return to the default screen.

NOTE

- Press **CANCEL** to return to the previous screen.
- If no operations are performed for approximately 1 minute, the display will return to the default screen.
- Indoor unit default setting: of (Airflow rate down)

Care

Care and Cleaning

CAUTION

- Before cleaning, be sure to stop the operation and turn off the circuit breaker.
- Do not touch the aluminum fins of the indoor unit. If you touch those parts, this may cause an injury.

Quick reference

Cleaning parts

Front panel

- Wipe with a soft cloth which has been moistened with water or neutral detergent.
- Only neutral detergent may be used.

If dirty



Air filter

- Vacuum dust or wash the filter.

Once every 2 weeks

▶ Page 26

Indoor unit, outdoor unit and remote controller

- Wipe them with a soft cloth.

If dirty

Titanium apatite deodorizing filter (with frame)

- Vacuum dust or replace the filter.

[Cleaning]

Once every 6 months

▶ Page 27

[Replacement]

Once every 3 years

▶ Page 27

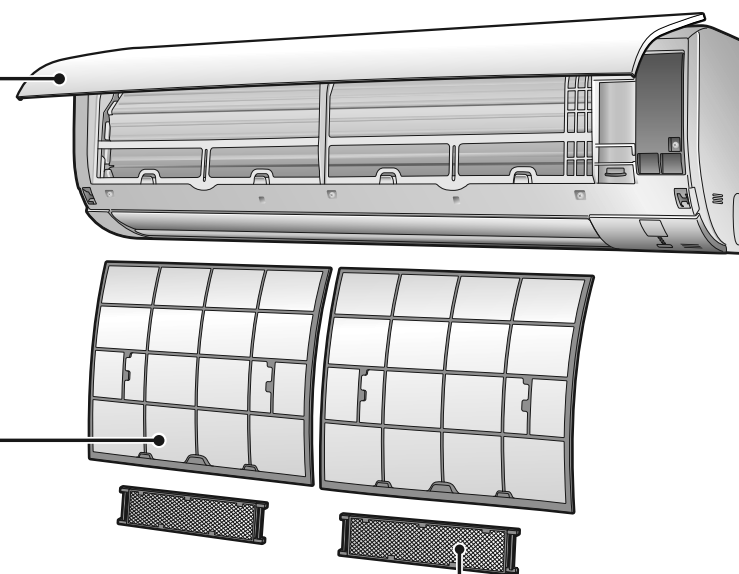

NOTE

For cleaning, do not use any of the following:

- Water hotter than 104°F (40°C)
- Volatile liquid such as benzine, gasoline and thinner
- Polishing compounds
- Rough materials such as a scrubbing brush
- Sprays such as deodorizers

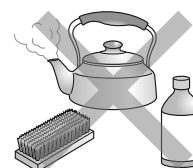

■ Air filter

1. Open the front panel.

- Hold the front panel by the sides and open it.

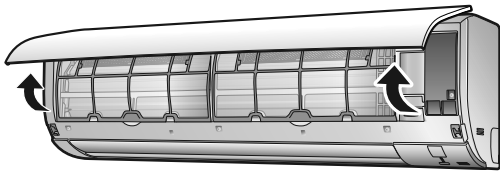

2. Pull out the air filters.

- Push the filter tab at the center of each air filter a little upwards, then pull it down.

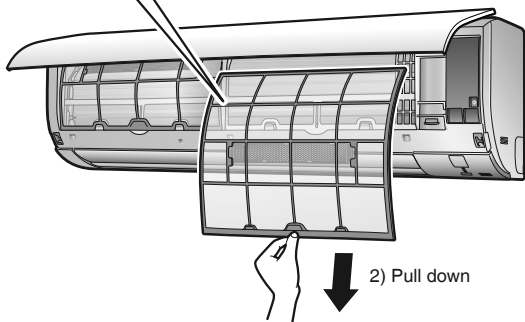
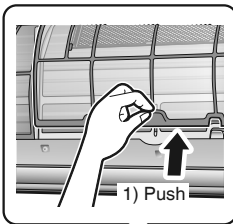

3. Wash the air filters with water or clean them with vacuum cleaner.

- It is recommended to clean the air filters every 2 weeks.

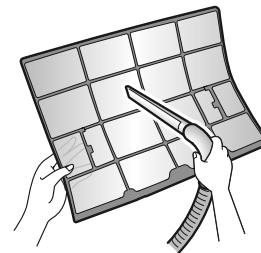

If the dust does not come off easily

- Wash the air filters with neutral detergent thinned with lukewarm water, then dry them up in the shade.
- Be sure to remove the titanium apatite deodorizing filter. Refer to "Titanium apatite deodorizing filter". ▶ Page 27

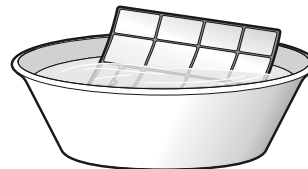

4. Reattach the filters.

5. Close the front panel slowly.

- Press the front panel at both sides and in the central area.

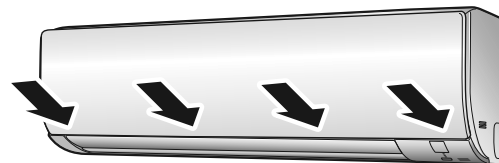

- Make sure that the front panel is securely fixed.

Care

Care and Cleaning

■ Titanium apatite deodorizing filter

1. Open the front panel and pull out the air filters. ▶Page 26

2. Take off the titanium apatite deodorizing filters.

- Hold the recessed parts of the frame and unhook the 4 claws.
- Remove the filters from the tab.

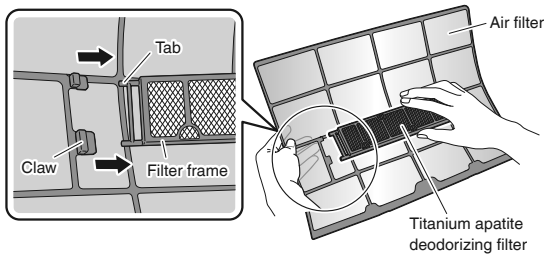

3. Clean or replace the titanium apatite deodorizing filters.

[Cleaning]

3-1 Vacuum dust, and soak in lukewarm water or water for about 10 to 15 minutes if very dirty.

- Do not remove the filter from the frame when washing with water.



3-2 After washing, shake off remaining water and let them dry in the shade.

- Do not wring out the filter to remove water from it.

[Replacement]

Remove the filter from the filter frame and prepare a new one.

- Do not throw away the filter frame. Reuse the filter frame when replacing the titanium apatite deodorizing filter.

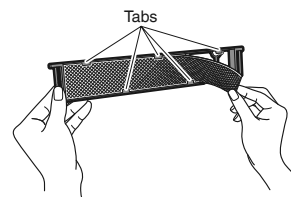

- Dispose of the old filter as non-flammable waste.

4. Set the titanium apatite deodorizing filters as they were.

- When attaching the filter, check that the filter is properly set in the tabs.
- The titanium apatite deodorizing filter can be attached in any orientation.

5. Reattach the filters. ▶Page 26

6. Close the front panel slowly.

▶Page 26

NOTE

- Operation with dirty filters:
 - cannot deodorize the air,
 - cannot clean the air,
 - results in poor heating or cooling,
 - may cause odor.
- Dispose of old filters as non-flammable waste.
- To order a titanium apatite deodorizing filter, contact the dealer where you bought the air conditioner.

| | |
|----------|---|
| Item | Titanium apatite deodorizing filter 1 set (2 pieces) |
| Part No. | KAF970A46 (without frame) |
| | KAF970A45 (with frame) |

■ Prior to a long period of non-use

1. Operate the FAN ONLY mode for several hours on a mild day to dry out the inside.

- Press **FAN ONLY**.

2. After operation stops, turn off the circuit breaker for the room air conditioner.

3. Clean the air filters and reattach them. [▶ Page 26](#)

4. To prevent battery leakage, take out the batteries from the remote controller.

- When starting to use the air conditioner again, make sure that the drain hose outlet is not blocked, then turn on the circuit breaker.
An operational check of each component will be carried out automatically. (Also, put the batteries into the remote controller.)

■ We recommend periodical maintenance

- In certain operating conditions, the inside of the air conditioner may get foul after several seasons of use, resulting in poor performance. It is recommended to have periodical maintenance by a qualified contractor in addition to regular cleaning by the user.
- For qualified contractor maintenance, please contact the dealer where you bought the air conditioner.

When the Need Arises

FAQ

Indoor unit

The flaps do not start swinging immediately.

- The air conditioner is adjusting the position of the flaps. The flaps will start moving soon.



The air conditioner stops generating airflow during HEAT operation.

- Once the set temperature is reached, the airflow rate is reduced and operation stopped in order to avoid generating a cool airflow. Operation will resume automatically when the indoor temperature falls.

HEAT operation stops suddenly and a flowing sound is heard.

- The outdoor unit is defrosting. HEAT operation starts after the frost on the outdoor unit has been removed. This can take about 4 to 12 minutes.

Operation does not start soon.

- **When the unit is turned on again soon after being turned off.**
- **When the mode was reselected.**
 - This is to protect the air conditioner. You should wait for about 3 minutes.

Different sounds are heard.

- **A sound like flowing water**
 - This sound is generated because the refrigerant in the air conditioner is flowing.
 - This is a pumping sound of the water in the air conditioner and can be heard when the water is pumped out from the air conditioner during COOL or DRY operation.
 - The refrigerant flows in the air conditioner even if the air conditioner is not working when the indoor units in other rooms are in operation.
- **Blowing sound**
 - This sound is generated when the flow of the refrigerant in the air conditioner is switched over.
 - If the outdoor temperature is low, this sound is generated when the direction of the flow of the refrigerant in the piping changes at the start of defrost operation, after HEAT operation is stopped and the room temperature is stabilized.
- **Ticking sound**
 - This sound is generated when the cabinet and frame of the air conditioner slightly expand or shrink as a result of temperature changes.
- **Whistling sound**
 - This sound is generated when refrigerant flows during defrosting operation.
- **Clicking sound during operation or idle time**
 - This sound is generated when the refrigerant control valves or the electrical parts operate.
- **Clopping sound**
 - This sound is heard from the inside of the air conditioner when the exhaust fan is activated while the room doors are closed. Open the window or turn off the exhaust fan.

Outdoor unit

Operating sound is loud.

- When frost forms on the heat exchanger of the outdoor unit, the operating sound level increases slightly.

The outdoor unit emits water or steam.

- **In HEAT operation**
 - The frost on the outdoor unit melts into water or steam when the air conditioner is in defrosting operation.
- **In COOL or DRY operation**
 - Moisture in the air condenses into water on the cool surface of the outdoor unit piping and drips.

Blowing sound

- If the outdoor temperature is low, this sound is generated when the direction of the flow of the refrigerant in the piping changes at the start of defrost operation, after HEAT operation is stopped and the room temperature is stabilized.

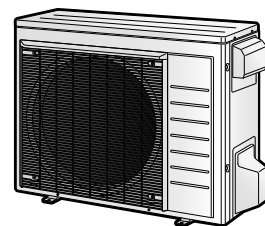

When the Need Arises

Troubleshooting

Before making an inquiry or a request for repair, please check the following.
If the problem persists, consult your dealer.



Not a problem

This case is not a problem.



Check

Please check again before requesting repairs.

The air conditioner does not operate

| Case | Description / what to check |
|-----------------------------|---|
| OPERATION lamp is off. | <ul style="list-style-type: none"> Has the circuit breaker been tripped or the fuse blown? Is there a power failure? Are batteries set in the remote controller? |
| OPERATION lamp is blinking. | <ul style="list-style-type: none"> Turn off the power with the circuit breaker and restart operation with the remote controller. If the OPERATION lamp is still blinking, check the error code and consult your dealer. ▶Page 33, 34 |

The air conditioner suddenly stops operating

| Case | Description / what to check |
|-----------------------------|---|
| OPERATION lamp is on. | <ul style="list-style-type: none"> To protect the system, the air conditioner may stop operating after sudden large voltage fluctuations. It automatically resumes operation in about 3 minutes. |
| OPERATION lamp is blinking. | <ul style="list-style-type: none"> Are the air filters dirty? Clean the air filters. Is there anything blocking the air inlet or air outlet of the indoor unit or outdoor unit? Stop operation and after turning off the circuit breaker, remove the obstruction. Then restart operation with the remote controller. If the OPERATION lamp is still blinking, check the error code and consult your dealer. ▶Page 33, 34 Are operation modes all the same for indoor units connected to outdoor units in the multi system? If not, set all indoor units to the same operation mode and confirm that the lamps. Moreover, when the operation mode is in AUTO, set all indoor unit operation modes to COOL or HEAT for a moment and check again that the lamps are normal. If the lamps stop blinking after the above steps, there is no malfunction. ▶Page 18, 19 |

The air conditioner does not stop operating

| Case | Description / what to check |
|--|--|
| The air conditioner continues operating even after operation is stopped. | <ul style="list-style-type: none"> Immediately after the air conditioner is stopped <ul style="list-style-type: none"> The outdoor unit fan continues rotating for about another 1 minute to protect the system. While the air conditioner is not in operation <ul style="list-style-type: none"> When the outdoor temperature is high, the outdoor unit fan may start rotating to protect the system. |

Wireless LAN connection

| When this happens | Explanation and where to check |
|---|---|
| The device (air conditioner) cannot be found on the device list screen. | <ul style="list-style-type: none"> Carry out connection setting again while the lamp blinks quickly. Move the router (wireless LAN access point) close to the indoor unit. ▶Page 20-22 There is a possibility that you are using an unsupported smart phone or router (wireless LAN access point). For details, refer to the web site. ▶Page 20-22 |
| Even if the wireless LAN connection adapter lamp is lit, operation from outside the home is not possible. | <ul style="list-style-type: none"> Communication between the router and the internet connection may not be working. Please confirm. |

When the Need Arises

Troubleshooting

The room does not cool down / warm up

| Case | Description / what to check |
|--|--|
| Air does not come out. | <ul style="list-style-type: none"> <input checked="" type="checkbox"/> ■ In HEAT operation <ul style="list-style-type: none"> • The air conditioner is warming up. Wait for about 1 to 4 minutes. • During defrosting operation, hot air does not flow out of the indoor unit. ■ When the air conditioner operates immediately after the circuit breaker is turned on <ul style="list-style-type: none"> • The air conditioner is preparing to operate. Wait for about 3 to 10 minutes. • When the outdoor temperature is below 40°F (5°C) and heating operation is started, the air conditioner is warming up. Wait for about 10 to 25 minutes. |
| Air does not come out / Air comes out. | <ul style="list-style-type: none"> <input type="checkbox"/> ■ Is the airflow rate setting appropriate? <ul style="list-style-type: none"> • Is the airflow rate setting low, such as "Indoor unit quiet" or "Airflow rate 1"? Increase the airflow rate setting. ■ Is the set temperature appropriate? ■ Is the adjustment of the airflow direction appropriate? |
| Air comes out. | <ul style="list-style-type: none"> <input type="checkbox"/> • Is there any furniture directly under or beside the indoor unit? • Is the air conditioner in ECONO operation? ▶ Page 15 • Are the air filters dirty? • Is there anything blocking the air inlet or air outlet of the indoor unit or outdoor unit? • Is a window or door open? • Is an exhaust fan turning? • Depending on the room conditions, number of occupants, or outdoor temperature and humidity, the set temperature may not be reached. <p>A temperature regulation function which factors in living space conditions is available. For further details, please contact your dealer.</p> |

Water or mist comes out

| Case | Description / what to check |
|--|--|
| Mist comes out of the indoor unit. | <ul style="list-style-type: none"> <input checked="" type="checkbox"/> • This happens when the air in the room is cooled into mist by the cold airflow during COOL or other operation. |
| Water is leaking from the indoor unit. | <ul style="list-style-type: none"> <input type="checkbox"/> • If the drain hose is crushed or clogged, water from the indoor unit may be unable to drain and start leaking. Stop operation of the unit immediately and contact your dealer. |

Remote controller

| Case | Description / what to check |
|--|---|
| The unit does not receive signals from the remote controller or has a limited operating range. | <ul style="list-style-type: none"> <input checked="" type="checkbox"/> • The batteries may be exhausted. Replace both batteries with new dry batteries AAA.LR03 (alkaline). For details, refer to "Preparation Before Operation". ▶ Page 9 • Signal communication may be disabled if an electronic-starter-type fluorescent lamp (such as inverter-type lamps) is in the room. Consult your dealer if that is the case. • The remote controller may not function correctly if the transmitter is exposed to direct sunlight. • Is there a device in the room that redirects remote controller signals? Some appliances such as TV speakers are equipped with these devices. If there is such a device in the room, the signals it emits may interfere with signals from the remote controller, preventing reception. • Infrared rays from smartphones and game consoles may interfere with signals from the remote controller, preventing reception. |
| LCD is faint, is not working, or the display is erratic. | <ul style="list-style-type: none"> <input checked="" type="checkbox"/> • The batteries may be exhausted. Replace both batteries with new dry batteries AAA.LR03 (alkaline). For details, refer to "Preparation Before Operation". ▶ Page 9 |
| The LCD is blinking and the remote controller cannot be operated. | <ul style="list-style-type: none"> <input checked="" type="checkbox"/> • Battery power has run out. Replace both batteries at the same time with new size AAA.LR03 (alkaline) batteries. Leaving exhausted batteries in the remote controller can result in injury due to battery leakage, rupturing or heating, or lead to equipment failure. (Even when the LCD is blinking, the OFF button remains functional.) |
| Other electric devices start operating. | <ul style="list-style-type: none"> <input checked="" type="checkbox"/> • If the remote controller activates other electric devices, move them away or consult your dealer. |

When the Need Arises

Air has an odor

| Case | Description / what to check |
|--|--|
| The air conditioner gives off an odor. | <input checked="" type="checkbox"/> • The room odor absorbed in the unit is discharged with the airflow. We recommend you to have the indoor unit cleaned. Please consult your dealer. |
| | <input checked="" type="checkbox"/> • The indoor unit is blowing out room odor it has absorbed (the smell of walls or carpeting, furniture, clothes, and so on). If the air conditioner has been used for a long time, there is a chance that a dirty heat exchanger or fan are emitting an odor. We recommend you to have the indoor unit cleaned. Please consult your dealer. Do not spray the air conditioner unit with any deodorizers. |

Display lamp

| Case | Description / what to check |
|--|---|
| The unit operates even though the OPERATION lamp is off. | <input type="checkbox"/> • Is lamp brightness set to “OFF”? ▶ Page 23 |
| The LED lamps on the unit are dim. | <input type="checkbox"/> • Is lamp brightness set to “L”? ▶ Page 23 |

Others

| Case | Description / what to check |
|--|--|
| The air conditioner suddenly starts behaving strangely during operation. | <input type="checkbox"/> • The air conditioner may malfunction due to lightning or radio. If the air conditioner malfunctions, turn off the power with the circuit breaker and restart the operation with the remote controller. |
| The ceiling and walls around the indoor unit are black and dirty. | <input checked="" type="checkbox"/> • Due to the circulation pattern of the air and static electricity, the air conditioner is causing airborne dirt and dust to stick to walls and other surfaces. Depending on the wallpaper type, dirt may adhere more easily. A thorough cleaning of the area around the air conditioner is recommended. |

Notes on the operating conditions

- If operation continues under any conditions other than those listed in the table,
 - A safety device may activate to stop the operation.
 - Dew may form on the indoor unit and drip from it when COOL or DRY operation is selected.
- *1 Cutting the jumper on the outdoor unit PCB will extend the cooling operation range to 14°F (–10°C).
 Installing an air direction adjustment grille (sold separately) will further extend the operation range to –4°F (–20°C).
 Please consult your dealer.
- *2 Installing a drain pan heater (sold separately) will further extend the heating operation range to –13°F (–25°C).
 Please consult your dealer.

| Mode | Operating conditions |
|------------|--|
| COOL / DRY | Outdoor temperature [RXT models] : 50*1 - 115°F (10*1 - 46°C) [MXM, MXT, MXTH models]: 14 - 115°F (–10 - 46°C) *1 –4°F (–20°C) if an air direction adjustment grille (sold separately) is installed. |
| | Indoor temperature : 64 - 90°F (18 - 32°C) |
| | Indoor humidity : 80% max. |
| HEAT | Outdoor temperature [MXM models] : 5 - 75°F (–15 - 24°C) [RXT, MXT models] : 5*2 - 75°F (–15*2 - 24°C) [MXTH models] : –13 - 75°F (–25 - 24°C) *2 –13°F (–25°C) if a drain pan heater (sold separately) is installed. |
| | Indoor temperature : 50 - 86°F (10 - 30°C) |

When the Need Arises

Troubleshooting

The OPERATION lamp blinks

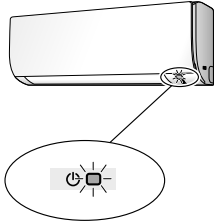

■ **Check the interval time between blinks of the OPERATION lamp.**

If connecting to multiple indoor units
[Blink interval of about 2 to 3 seconds]
 Check the operation mode of any indoor units connected in other rooms. Because this is a multi system air conditioner, it has one outdoor unit connected to multiple indoor units in different rooms. If the operation mode is different from the operation mode of the indoor unit in another room, the OPERATION lamp may blink and operation may not be performed, or operation may stop while in progress. COOL, DRY and HEAT operation may not be used at the same time.

[Blink interval of about 0.5 seconds]
 This is a notification of an abnormality. Check the error code following the procedure below, and respond according to the instructions in the table.



■ **Fault diagnosis by remote controller**

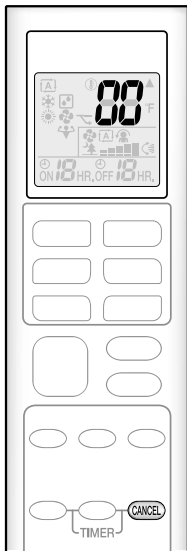

1. When **CANCEL** is held down for about 5 seconds, “00” blinks in the temperature display section.

2. While pointing the remote controller at the indoor unit, press **CANCEL** repeatedly.

A beep indicates a non-corresponding error code.
 A long beep indicates a corresponding error code.

3. When a long beep is produced, check the error code and respond according to the instructions in the table.

- To cancel the code display, hold down **CANCEL** for about 5 seconds (the code display also clears if no button is pressed for a while).

| CODE | Cause | Description / what to check |
|---|--|---|
| E7 | The fan of the outdoor unit is stopped. • Is there any foreign matter inside the outdoor unit? | After turning off the circuit breaker, remove the foreign matter, then turn the power on again and operate. |
| L3, L4, L5 | The temperature inside the outdoor unit has become too high, so operation has stopped. • Is there anything blocking the air outlet of the outdoor unit? | After turning off the circuit breaker, remove the obstruction, then turn the power on again and operate. |
| Other error codes, or if the error code cannot be checked | | An abnormality has occurred. |

In the case of error code **U0** or **F3**

When the Need Arises

| | CODE | MEANING |
|---------------------|---|---|
| SYSTEM | 00 | NORMAL |
| | UA | INDOOR-OUTDOOR UNIT COMBINATION FAULT |
| | U0 | REFRIGERANT SHORTAGE |
| | U2 | DROP VOLTAGE OR MAIN CIRCUIT OVERVOLTAGE |
| | U4 | FAILURE OF TRANSMISSION (BETWEEN INDOOR UNIT AND OUTDOOR UNIT) |
| INDOOR UNIT | A1 | INDOOR PCB DEFECTIVENESS |
| | A5 | HIGH PRESSURE CONTROL OR FREEZE-UP PROTECTOR |
| | A6 | FAN MOTOR FAULT |
| | C4 | FAULTY HEAT EXCHANGER TEMPERATURE SENSOR |
| | C9 | FAULTY SUCTION AIR TEMPERATURE SENSOR |
| OUTDOOR UNIT | CC | FAULTY HUMIDITY SENSOR |
| | EA | COOLING-HEATING SWITCHING ERROR |
| | E1 | CIRCUIT BOARD FAULT, ELECTRONIC EXPANSION VALVE COIL DRIVER FAULT |
| | E3* | HIGH PRESSURE SWITCH (HPS) ACTIVATED |
| | E5 | OL (COMPRESSOR OVERLOAD) STARTED, HIGH PRESSURE SWITCH (HPS) ACTIVATED* |
| | E6 | FAULTY COMPRESSOR START UP |
| | E7 | DC FAN MOTOR FAULT |
| | E8 | OVERCURRENT INPUT |
| | E9 | ELECTRONIC EXPANSION VALVE COIL FAULT |
| | F3 | HIGH TEMPERATURE DISCHARGE PIPE CONTROL |
| | F6 | HIGH PRESSURE CONTROL (IN COOLING) |
| | F8 | OPERATION HALT DUE TO COMPRESSOR INTERNAL TEMPERATURE ABNORMALITY |
| | H0 | SENSOR FAULT |
| | H3 | HIGH PRESSURE SENSOR ABNORMALITY |
| | H6 | OPERATION HALT DUE TO FAULTY POSITION DETECTION SENSOR |
| | H7 | FAN IPM TEMPERATURE ERROR |
| | H8 | DC CURRENT SENSOR FAULT |
| | H9 | FAULTY SUCTION AIR TEMPERATURE SENSOR |
| | J3 | FAULTY DISCHARGE PIPE TEMPERATURE SENSOR |
| | J6 | FAULTY HEAT EXCHANGER TEMPERATURE SENSOR |
| L3 | ELECTRICAL PARTS HEAT FAULT | |
| L4 | HIGH TEMPERATURE AT INVERTER CIRCUIT HEATSINK | |
| L5 | OUTPUT OVERCURRENT | |
| P4 | FAULTY INVERTER CIRCUIT HEATSINK TEMPERATURE SENSOR | |

*The contents of the error differ depending on the connected outdoor unit.

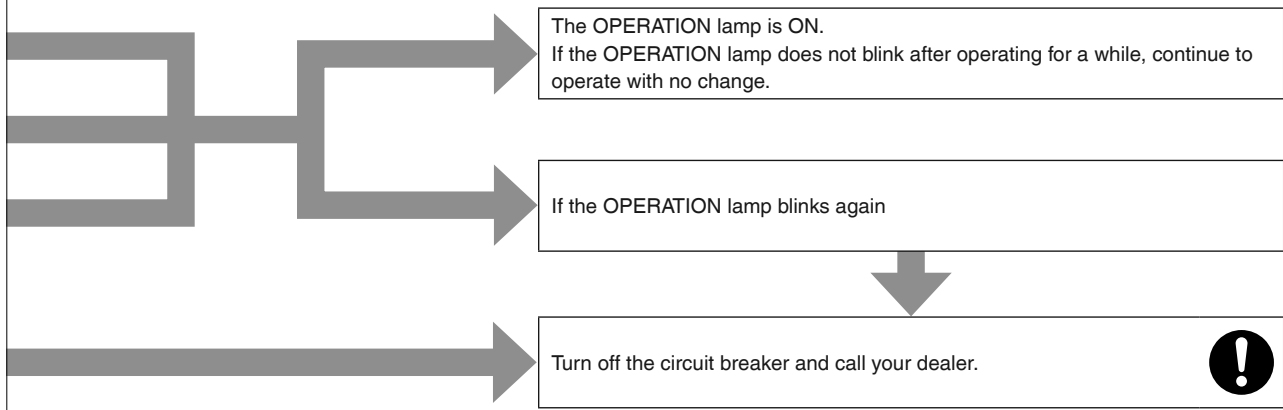

When the Need Arises

Troubleshooting

■ Call your dealer immediately

WARNING

When an abnormality (such as a burning smell) occurs, stop operation and turn off the circuit breaker.

- Continued operation in an abnormal condition may result in problems, electric shock or fire.
- Consult the dealer where you bought the air conditioner.

Do not attempt to repair or modify the air conditioner by yourself.

- Incorrect work may result in electric shock or fire.
- Consult the dealer where you bought the air conditioner.

If one of the following symptoms takes place, call your dealer immediately.

- The power cord is abnormally hot or damaged.
- An abnormal sound is heard during operation.
- The circuit breaker cuts off the operation frequently.
- A switch or a button often fails to work properly.
- There is a burning smell.
- Water leaks from the indoor unit.

Turn off the circuit breaker and call your dealer. 

- **After a power failure**
 - The air conditioner automatically resumes operation in about 3 minutes. Please wait for a while.
- **Lightning**
 - If there is a risk lightning could strike in the neighborhood, stop operation and turn off the circuit breaker to protect the system.

■ Disposal requirements

- Dismantling of the unit, handling of the refrigerant, oil and other parts, should be done in accordance with the relevant local and national regulations.

Part 4 Options

| | |
|--|-----|
| 1. Options List..... | 152 |
| 1.1 Indoor Unit | 152 |
| 1.2 Outdoor Unit | 152 |
| 2. Control Devices | 153 |
| 2.1 <BRC073A6> Wired Remote Controller (Installation) | 153 |
| 2.2 <BRC073A6> Wired Remote Controller (Operation)..... | 182 |
| 2.3 <BRC944B2> Wired Remote Controller (Installation) | 225 |
| 2.4 <BRC944B2> Wired Remote Controller (Operation)..... | 227 |
| 2.5 <BRCW901A03/08> Wired Remote Controller Cord..... | 239 |
| 2.6 <KRP413BB1S> Wiring Adaptor | 240 |
| 2.7 <DCS302C71> Central Remote Controller (Installation) | 244 |
| 2.8 <DCS302C71> Central Remote Controller (Operation) | 249 |
| 2.9 <DCS301C71> Unified ON/OFF Controller (Installation) | 275 |
| 2.10 <DCS301C71> Unified ON/OFF Controller (Operation)..... | 280 |
| 2.11 <DST301BA61> Schedule Timer Controller (Installation) | 282 |
| 2.12 <DST301BA61> Schedule Timer Controller (Operation)..... | 287 |
| 2.13 <KRP928BB2S> Interface Adaptor for DIII-NET | 300 |
| 2.14 <KRP067A41> Remote Control PC-Board Set | 303 |
| 3. Outdoor Unit | 307 |
| 3.1 <KPW063B4> Air Direction Adjustment Grille | 307 |
| 3.2 <KKG063A44> Back Protection Wire Net | 309 |
| 3.3 <KEH064A41> Drain Pan Heater | 310 |
| 3.4 <KPS063A41> Snow Hood (Side)..... | 314 |
| 3.5 <KPS063A44> Snow Hood (Rear) | 316 |
| 3.6 <KPS063A47> Snow Hood (Discharge)..... | 318 |

1. Options List

1.1 Indoor Unit

| Option Name | | Model Name |
|--|----------------------|-----------------------|
| Wired remote controller ★1 | | BRC944B2, BRC073A6 |
| Wired remote controller cord (shielded wire) | Length 9.8 ft (3 m) | BRCW901A03 |
| | Length 26.3 ft (8 m) | BRCW901A08 |
| Wiring adaptor for timer clock / remote controller ★2 (normal open pulse contact / normal open contact) | | KRP413BB1S |
| Central remote controller ★3 | | DCS302C71 |
| Unified ON/OFF controller ★3 | | DCS301C71 |
| Schedule timer controller ★3 | | DST301BA61 |
| Interface adaptor for DIII-NET (residential air conditioner) | | KRP928BB2S |
| Titanium apatite deodorizing filter (without frame) | | KAF970A46 ★4 |
| Remote controller loss prevention with chain | | KKF936A4 |

★1 A wired remote controller cord BRCW901A03 or BRCW901A08 is necessary.

★2 Timer clock and other devices; obtained locally.

★3 An interface adaptor (KRP067A41) is also required for each indoor unit.

★4 Standard accessory

1.2 Outdoor Unit

| Option Name | Standard | Cold Climate | |
|---------------------------------|-----------|--------------|-----------|
| | 2/3/4MXM | 2MXT | 2MXTH |
| Air direction adjustment grille | KPW063B4 | KPW063B4 | KPW063B4 |
| Back protection wire net | KKG063A44 | KKG063A44 | KKG063A44 |
| Drain plug ★ | KKP937A4 | KKP937A4 | KKP937A4 |
| Drain pan heater | KEH064A41 | KEH064A41 | — |
| Snow hood (intake side plate) | KPS063A41 | KPS063A41 | KPS063A41 |
| Snow hood (intake rear plate) | KPS063A44 | KPS063A44 | KPS063A44 |
| Snow hood (outlet) | KPS063A47 | KPS063A47 | KPS063A47 |

★ Standard accessory

2. Control Devices

2.1 <BRC073A6> Wired Remote Controller (Installation)

Safety Considerations



1. Safety Considerations

The original instructions are written in English. All other languages are translations of the original instructions.

■ Also see the installation manual attached to the indoor unit.

Please read these Safety Considerations carefully before installing the user interface.

- This manual classifies the precautions into WARNING and CAUTION. They both contain important information regarding safety. Be sure to follow all the precautions below.

| | |
|--|---|
|  WARNING | Failure to follow these instructions properly may result in personal injury or loss of life. |
|  CAUTION | Failure to observe these instructions properly may result in property damage or personal injury, which may be serious depending on the circumstances. |

- After completing the installation, conduct a trial operation to check for faults and explain to the customer how to operate the air conditioner with the aid of the User reference guide. Ask the customer to store the Installer reference guide along with the User reference guide for future reference.

Safety Considerations

 WARNING

| |
|--|
| <p>Ask your dealer or qualified personnel to carry out installation work. Do not attempt to install the user interface yourself. Improper installation may result in water leakage, electric shocks or fire.</p> |
| <p>Consult your local dealer regarding relocation and reinstallation of the user interface. Improper installation work may result in leakage, electric shocks or fire hazards.</p> |
| <p>Install the user interface in accordance with the instructions in this Installer reference guide. Improper installation may result in water leakage, electric shocks or fire.</p> |
| <p>Be sure to use only the specified accessories and parts for installation work. Failure to use the specified parts may result in the unit falling down, water leakage, electric shocks or fire.</p> |
| <p>Install the user interface on a foundation strong enough to withstand the weight of the user interface. Insufficient strength may result in the user interface falling down and causing injury.</p> |
| <p>Electrical work must be performed in accordance with the relevant local and national regulations and with the instructions in this Installer reference guide. Be sure to use a dedicated power supply circuit only. Insufficient power circuit capacity and improper workmanship may result in electric shocks or fire.</p> |
| <p>Always perform installation work with the power turned off. Touching electric parts may result in electric shock.</p> |
| <p>Do not disassemble, reconstruct or repair. This may result in electric shock and/or fire.</p> |
| <p>Make sure that all wiring is secured, the specified wires are used and that there is no strain on the terminal connections or wires. Improper connections or securing of wires may result in abnormal heat build-up or fire.</p> |
| <p>The choice of materials and installations must comply with the applicable national and international standards.</p> |

Safety Considerations

⚠ CAUTION

To avoid leakage and electric shock due to entry of water or insects, fill the wiring through hole with putty.

To avoid electric shocks, do not operate with wet hands.

Do not wash the user interface with water, as this may result in electric shocks or fire.

Install the indoor and outdoor units, power cord and connection wires at least 3.3ft (1m) away from televisions or radios to prevent interference and noise.

(Depending on the incoming signal strength, a distance of 3.3ft (1m) may not be sufficient to eliminate noise.)

Do not install the air conditioner in the following locations:

1. Where there is a high concentration of mineral oil spray or vapor (e.g. a kitchen).
Plastic parts may deteriorate and fall off which could result in water leakage.
2. Where corrosive gas, such as sulphurous acid gas, is produced.
Corroding of copper pipes or soldered parts may result in refrigerant leakage.
3. Near machinery emitting electromagnetic radiation.
Electromagnetic radiation may disturb the operation of the control system and result in malfunctioning of the unit.
4. Where flammable gas may leak, where there is carbon fiber or ignitable dust suspensions in the air or where volatile flammables such as paint thinner or gasoline are handled.
Operating the unit in such conditions may result in fire.
5. High temperature areas or direct flames.
Overheating and/or fire may occur.
6. Moist areas or places which may be exposed to water.
If water enters the user interface, electric shock may be caused and the inner electronics may fail.

When the thermostat function of the user interface is used, select the installation location while considering it should be a place:

- Where the average temperature in the room can be detected.
- Which is not exposed to direct sunlight.
- Which is not near a heat source.
- Which is not affected by the outside air or air draught due to, for example, opening/closing of doors, the air outlet of the indoor unit or the like.
- Which is NOT located outdoors.

Accessories

2. Accessories

Not included but required: BRCW901A*.

| Item No. | Length |
|------------|--------|
| BRCW901A03 | 10ft |
| BRCW901A08 | 26ft |

3. User interface installation procedure

3-1 Determine where to install the user interface.

Make sure to follow "1. Safety Considerations" when determining the location.

3-2 Make a wiring through hole on the wall if the wires are coming out from the rear.

[Unit: inch (mm)]

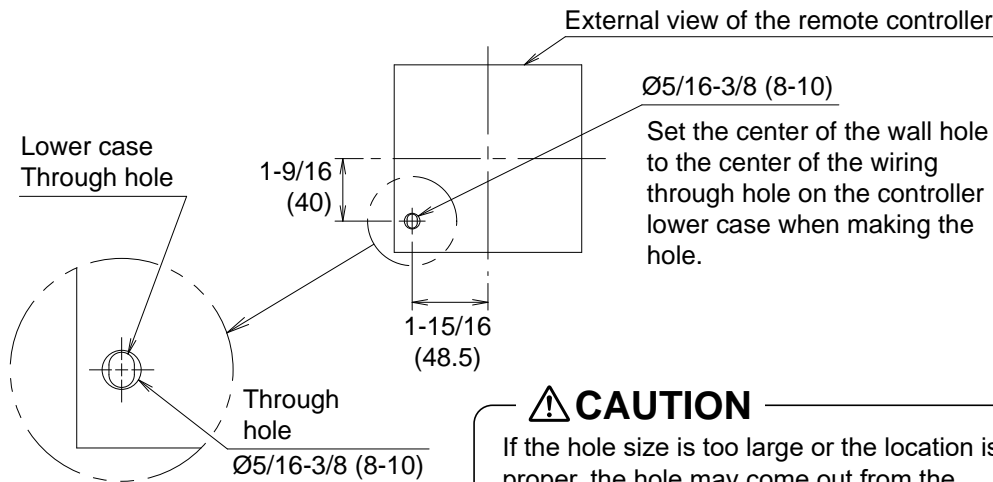

User interface installation procedure

3-3 Remove upper case.

Insert a screwdriver in the recess of lower case to remove the upper case (2 points).

Remote controller printed-circuit board is installed on the upper case. Be careful not to damage the printed-circuit board with the screwdriver.

Be careful not to let dust or moisture touch the printed-circuit board.

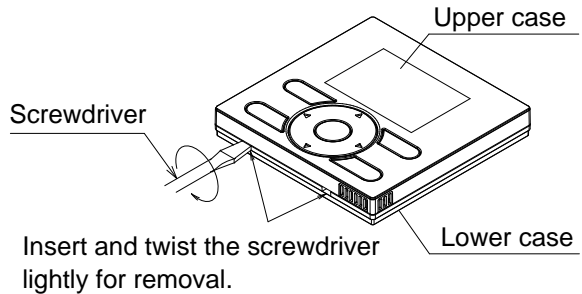

3-4 Determine the direction of the controller wiring outlet (rear outlet, left outlet, top left outlet).

3-4-1 Rear outlet

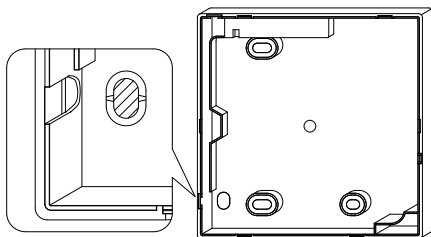

Cut off the resin area (hatched area).

3-4-2 Left outlet

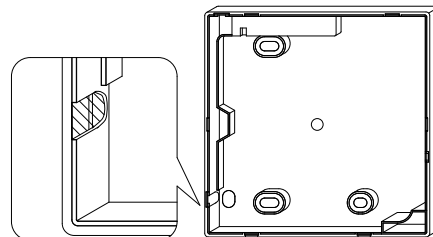

Cut off the thin area (hatched area) with nippers or the like and then remove the burrs with a file or the like.

3-4-3 Top left outlet

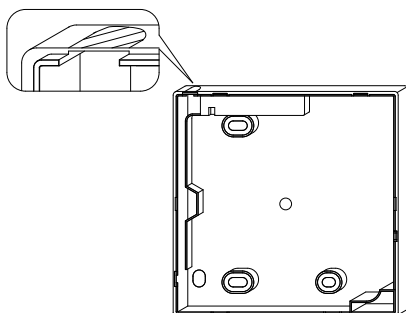

Cut off the thin area (hatched area) with nippers or the like and then remove the burrs with a file or the like.

User interface installation procedure

3-5 Securing the user interface adapter.

Remove the upper case of the user interface adapter and secure the lower case assembly.

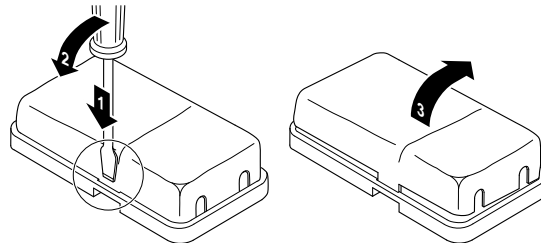

3-6 Conduct wiring.

3-6-1 Connections overview

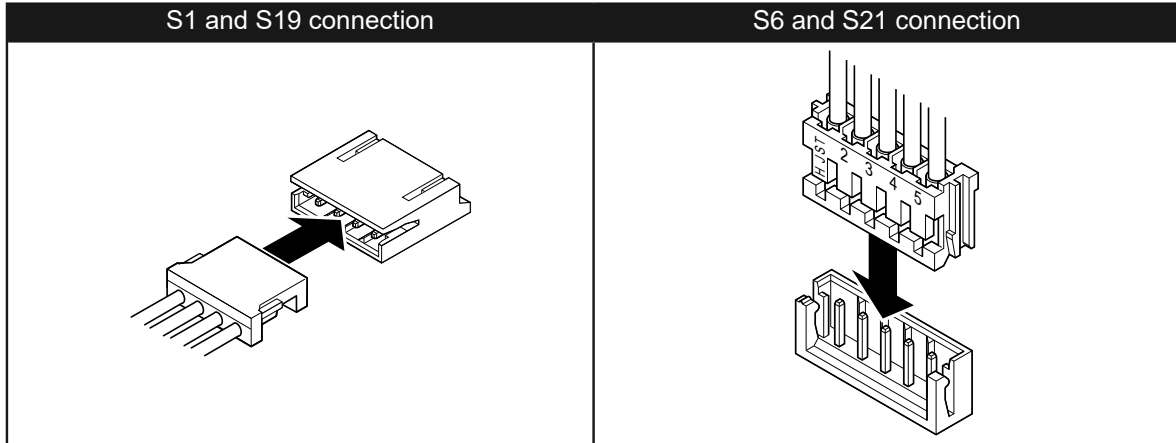

3-6-2 Rear outlet

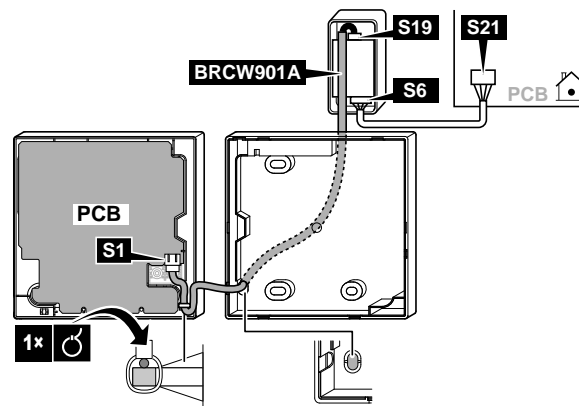

3-6-3 Left outlet

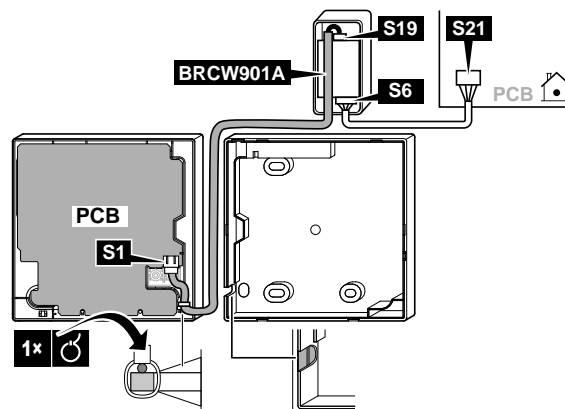

User interface installation procedure

3-6-4 Top left outlet

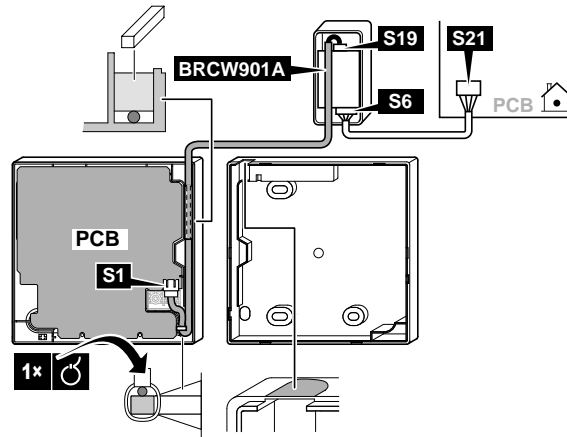

CAUTION

- Do not perform wiring close to a power line in order to avoid electrical noise (external noise).
- Seal the wiring draw-in port securely with putty (field supply) to prevent the entry of insects or the like.

CAUTION

- The adapter does not provide any form of strain release. The installer must provide something to release the strain on the cables near the adapter.

NOTICE

- Ground both ends of the BRCW901A* option cable.

3-7 Fixing procedure of the lower case.

In the case of wiring a user interface through the rear outlet, perform the wiring through the outlet hole in the lower case before it is installed on the wall.

3-7-1 Wall mounting

Secure by using furnished wood screws (2 pcs.).

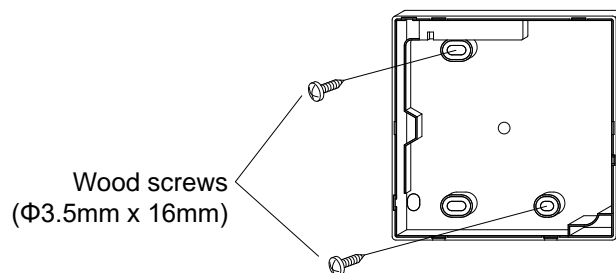

3-7-2 Switchbox mounting

Secure by using furnished small screws (2 pcs).

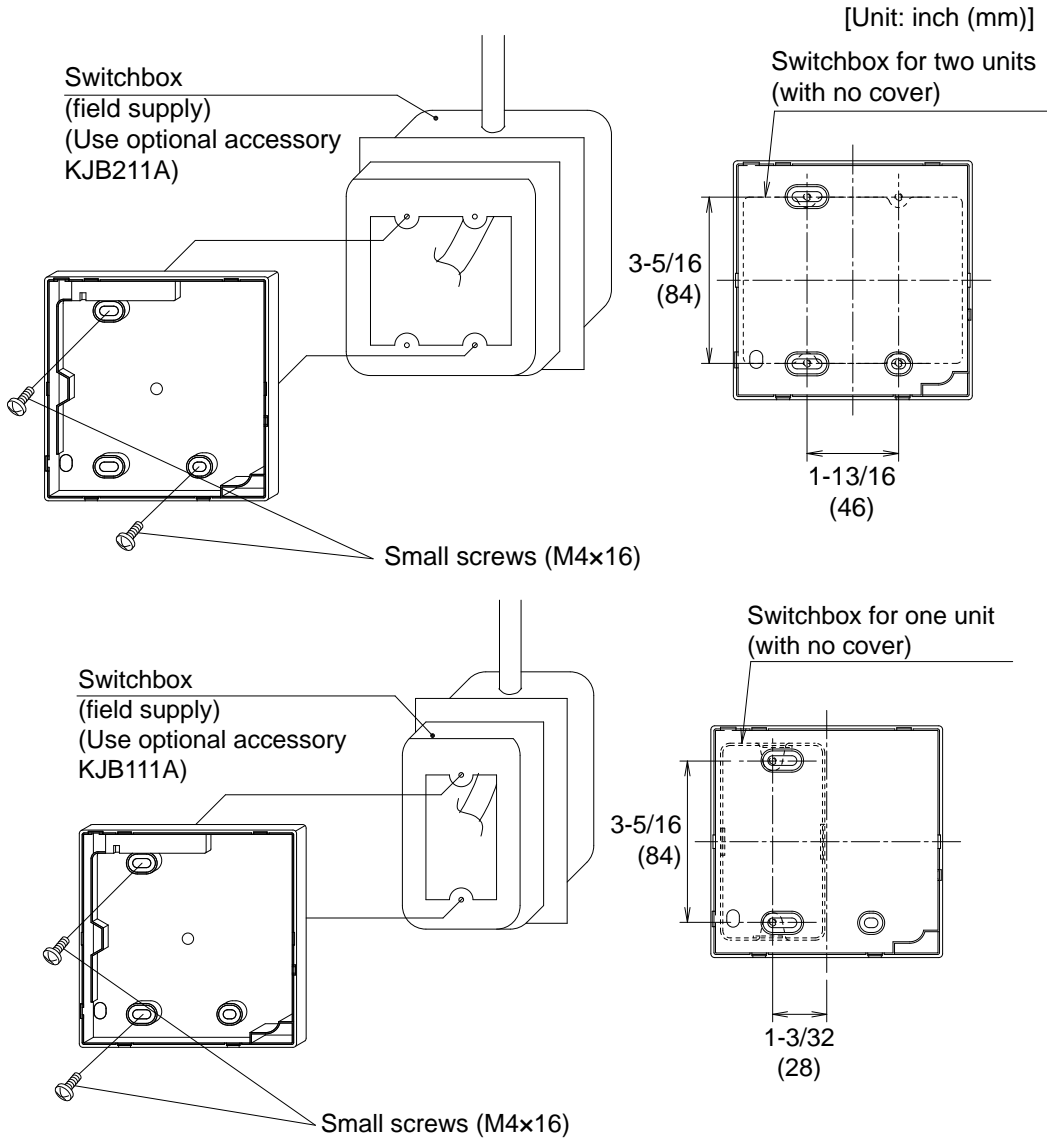

⚠ CAUTION

- Select a flat surface for installation if possible.
- Do not tighten the installation screws too much to avoid deforming the lower case.

User interface installation procedure

3-8 Attach the upper case.

- Align the upper case with the tabs of the lower case (6 points) and insert the upper case.
- Be careful not to pinch the wiring when attaching.
- Peel off the protective seal which is attached to the upper case.

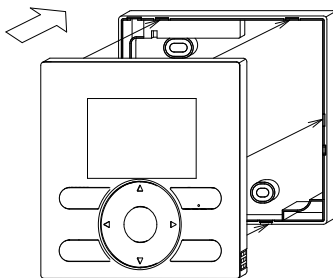

Functions and menu items of the user interface buttons

4. Functions and menu items of the user interface buttons

4-1 Functions and menu items

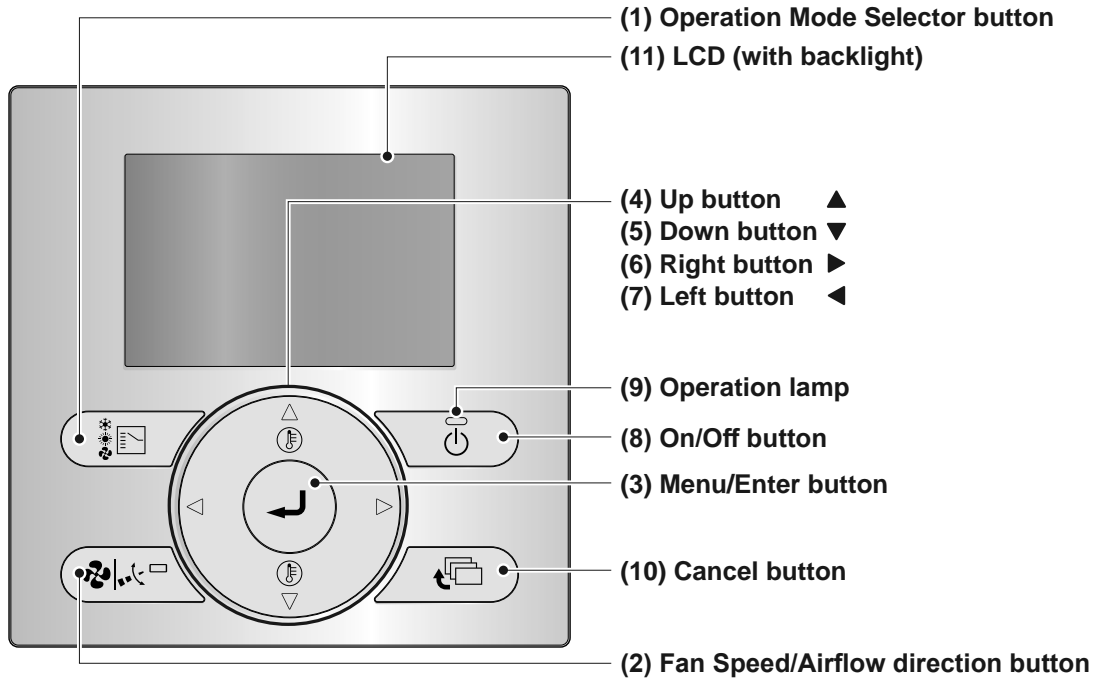

(1) Operation Mode Selector button

- This button is enabled by default. To disable, refer to "13. Prohibit Buttons" on page 27.
- Press this button to select the operation mode of your preference.
- Available modes may vary with the connected model.

(2) Fan Speed/Airflow direction button

- Used to change the fan speed and airflow direction.
- Available fan speeds and airflow directions may vary with the connected model.

(3) Menu/Enter button

- This button is enabled by default. To disable, refer to "4-2 Enable/disable the Menu/Enter and Cancel button" on page 14.
- Used to display the main menu or enter the selected item. (For details on the main menu, see the User reference guide.)

Main menu*

- Airflow Direction
- Energy Saving Options
- Schedule
- Maintenance Information
- Configuration
- Current Settings
- Clock & Calendar
- Language

(4) Up button ▲

- Used to raise the set temperature.
- The next item on the upper side will be highlighted. (Keep pressing the button to cycle through the values or items.)
- Used to change the selected item.

Functions and menu items of the user interface buttons

(5) Down button ▼

- Used to lower the set temperature.
- The next item on the lower side will be highlighted.
(Keep pressing the button to cycle through the values or items.)
- Used to change the selected item.

(6) Right button ►

- Used to highlight the next item on the right-hand side.
- The display contents are changed to the next screen.

(7) Left button ◀

- Used to highlight the next items on the left-hand side.
- The display contents are changed to the previous screen.

(8) On/Off button

- Press to start or stop the air conditioner.

(9) Operation lamp (Green)

- This lamp lights up during operation.
- This lamp will blink if an error or mode conflict occurs.
- This lamp is not lit when the unit operation is OFF.

(10) Cancel button

- Used to return to the previous screen.
- Press and hold this button for 4 seconds or longer to display the Service Settings menu.

(11) LCD (with backlight)

- The backlight will be lit for approximately 30 seconds when one of the buttons is pressed.
- The actions linked to the buttons, except for the On/Off button, are not carried out when the backlight is not lit.

Service Settings menu*



*Available menu items are depending on the connected model.

**Not displayed in case of multi-split setup.

⚠ CAUTION

- To operate the Up/Down/Left/Right button, always press ▲, ▼, ◀, or ▶.

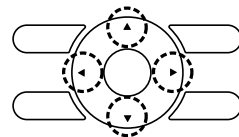

Functions and menu items of the user interface buttons

4-2 Enable/disable the Menu/Enter and Cancel button

To disable the Menu/Enter and Cancel button in the Basic screen, proceed as follow:

1. Keep the ► button pressed.
2. Push the 3 indicated keys simultaneously while keeping the ► button pressed.

To enable the Menu/Enter and Cancel button in the Basic screen, follow the same procedure.

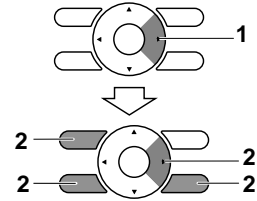

4-3 Description of button operation

<Main Menu>

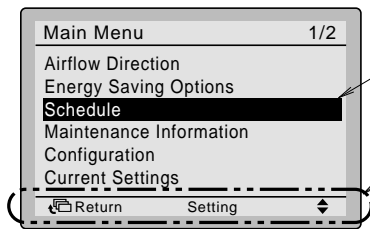

Highlighted display (selected items)

Instructions for manipulating the buttons will appear.

Power-on

5. Power-on

- Check that the indoor/outdoor unit wiring is completed.
- Check that the switchbox cover of the indoor and outdoor units are closed before powering on.

Split air conditioner is connected to a user interface

5-1 Turn on the power.

5-2 "Checking the connection.
Please stand by." is displayed.

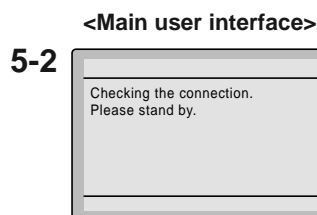

NOTE

When the text on the left is displayed, the backlight does not light up when one of the buttons is pressed.

5-3 The Basic screen is displayed.

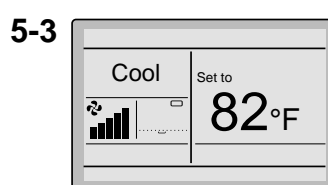

NOTE

- When selecting a different language, refer to "12. Language" on page 26.
- The displayed operation mode on the user interface at first startup depends on the operation mode of the indoor unit.

6. Field settings

6-1 Press and hold the Cancel button for 4 seconds or longer. The Service Settings menu is displayed.

6-1

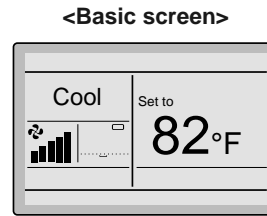

6-2 Select **Field Settings** and press the Menu/Enter button.

6-2

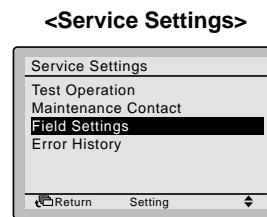

6-3 Highlight the "Mode No.", and select the desired "Mode No." by using the ▲▼ (Up/Down) buttons. For the most commonly used field settings, refer to page 17.

6-3

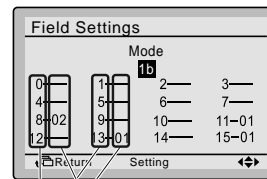

SECOND CODE NO.
FIRST CODE (SW) NO.

- The current settings are displayed.
- CODE NO. " -- " means that there is no function available.

6-4 Highlight the SECOND CODE. of the FIRST CODE NO. to be changed and select the desired SECOND CODE NO. by using the ▲▼ (Up/Down) buttons. Multiple identical mode number settings are available.

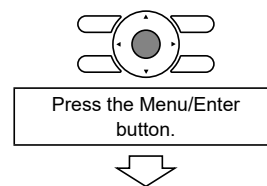

6-5 Press the Menu/Enter button. The confirmation screen is displayed.

6-5

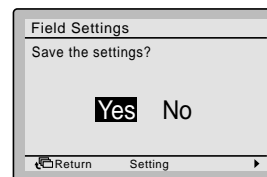

6-6 Select **Yes** and press the Menu/Enter button. The settings are saved and the Field settings screen returns.

6-6

Field settings

- 6-7** After all changes are completed, press the Cancel button twice.
- 6-8** The backlight goes out and "Checking the connection. Please stand by" is displayed during initialization. After the initialization, the Basic screen returns.

| Mode No. | First Code No. | Description of the setting | Second code No. | | | |
|----------|----------------|----------------------------|-----------------|-----------|-----------|----------------|
| | | | 01 | 02 | 03 | 04 |
| 1b | 8 | Daylight Saving Time | Disable | Enable* | — | — |
| | 11 | (Private use) | NA* | NA | — | — |
| | 13 | Basic screen display | Icon+Text* | Icon | — | — |
| | 15 | (Private use) | NA* | NA | — | — |
| 1c | 0 | (Private use) | NA | NA* | — | — |
| | 2 | (Private use) | NA | NA* | — | — |
| | 4 | (Private use) | NA | NA* | — | — |
| | 5 | (Private use) | NA* | — | — | — |
| | 6 | (Private use) | NA* | — | — | — |
| | 14 | (Private use) | NA* | NA | — | — |
| 1e | 1 | (Private use) | NA | NA* | — | — |
| | 2 | Setback function | Do not use | Heat only | Cool only | Cool and Heat* |
| | 5 | (Private use) | NA | NA* | — | — |
| | 6 | (Private use) | NA | NA* | — | — |
| | 8 | (Private use) | NA* | — | — | — |
| | 9 | (Private use) | NA | NA* | — | — |
| | a | (Private use) | NA* | — | — | — |

* Factory default setting

Test operation method (pair split only)

7. Test operation method (pair split only)

* In case of multi-split models, see the manual attached to the outdoor unit.

NOTE

- In case of multi-split setup, test operation cannot be used.

Also see the installation manuals attached to the indoor unit and the outdoor unit.

- Check that the wiring of the indoor unit and the outdoor unit is completed.
- Check that the switchbox cover of the indoor unit and the outdoor unit is closed.
- Perform the test operation according to the following procedure.

NOTE

- The backlight will be lit for approximately 30 seconds when pressing one of the operation buttons.
- Operate the buttons only when the backlight is lit. However, the On/Off button can be operated when the backlight is not lit.

7-1 Make sure the electric work is properly completed and proper voltage is available before turn on the power.

CAUTION

Make sure that the outer panel and piping cover are closed before operation (danger of electric shock).

7-2 Confirm that both the liquid and gas stop valves are opened.

7-3 Set the operation mode to cooling by using the Operation Mode Selector button.

7-3
7-4

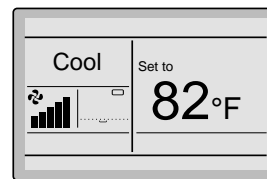

Press and hold the Cancel button for 4 seconds or longer while the backlight is lit.

7-4 Press and hold the Cancel button for 4 seconds or longer. The Service Settings menu is displayed.

<Service Settings>

Test operation method (pair split only)

7-5 Select **Test Operation** and press the Menu/Enter button. The Basic screen returns and "Test operation" is displayed.

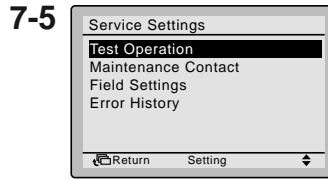

Press the Menu/Enter button.

7-6 Press the On/Off button within about 10 seconds. Test operation starts. Check the operation condition for 3 minutes.

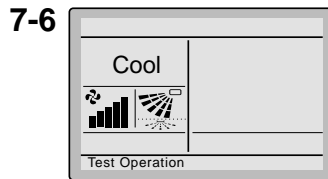

Press the On/Off button (within 10 seconds).

NOTE

Test operation can also be started by first performing 7-6, followed by 7-5.

7-7 Press the Menu/Enter button in the Basic screen. The Main menu is displayed.

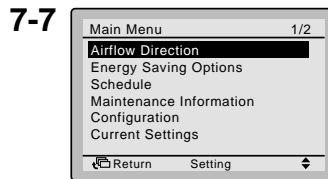

Press the Menu/Enter button.

7-8 Select **Airflow Direction** and press the Menu/Enter button.

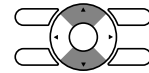
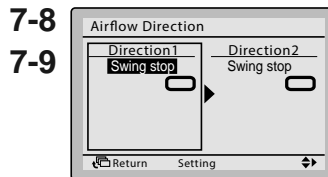

Change the airflow direction using the ▲▼ (Up/Down) buttons.

7-9 Press the ▲▼ buttons to select the desired airflow direction and press the Menu/Enter button. The Basic screen returns.



Press the Menu/Enter button.

7-10 Press and hold the Cancel button for 4 seconds or longer in the Basic screen. The Service Settings menu is displayed.

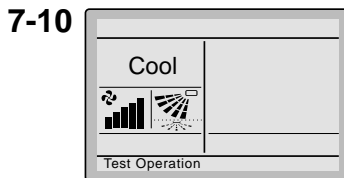

Press and hold the Cancel button for 4 seconds or longer while the backlight is lit.

<Service Settings menu>

Test operation method (pair split only)

7-11 Select **Test Operation** in the Service Settings menu and press the Menu/Enter button. The Basic screen returns and normal operation is possible.

7-11

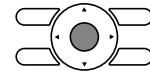
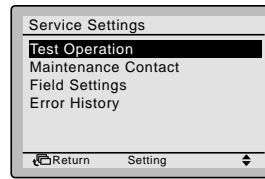

Press the Menu/Enter button.

<Basic screen>

7-12 Check the functions according to the User reference guide.

7-13 When the decoration panel is not installed, turn off the power after test operation finishes.

NOTE

Test operation will automatically finish after 30 minutes.

CAUTION

- If the interior work is not completed when the test operation is finished, explain to the customer that he should not operate the unit until the interior work is completed in order to protect the indoor unit.
- (If the indoor unit is operated, the indoor unit may be contaminated with the materials which arise from paints or adhesives during the interior work and water splash or water leak may occur.)

CAUTION

- If it is not possible to operate the unit due to any malfunction, refer to **Malfunction diagnosis method**.
- When the test operation finishes, check that the error code history is not displayed in the Maintenance Information screen according to the following procedure.

7-14 Press the Menu/Enter button in the Basic screen. The Main menu is displayed.

7-14

<Basic screen>

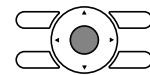
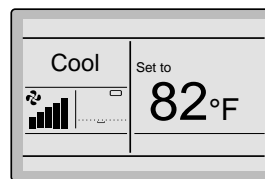

Press the Menu/Enter button.

<Main menu>

7-15 Select **Maintenance Information** and press the Menu/Enter button.

7-15

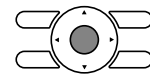
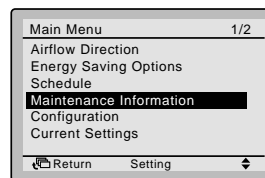

Press the Menu/Enter button.

Test operation method (pair split only)

7-16 The Maintenance Information screen is displayed. Check that the last error code is not displayed in the screen.

7-17 If the last error code is displayed, conduct the malfunction diagnosis referring to "Error code list" in the installation manual of the indoor unit. After the malfunction diagnosis finishes, press and hold the On/Off button for 4 seconds or longer in the "Maintenance Information" screen to erase the error code history.

7-16
7-17

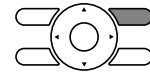
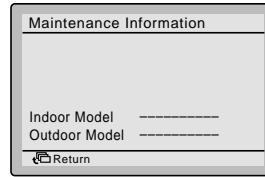

Press and hold the On/Off button for 4 seconds or longer.

NOTE

If no error code is displayed when this procedure is followed, the system has completed the test operation normally.

Malfunction diagnosis method

- When the user interface displays any item in the following table, inspect the details in the table.
- If an error occurs, "Error: Push Menu button" or "⚠" is displayed. Conduct the malfunction analysis referring to "Error code list" in the installation manual of the indoor unit. To see the RC Error History screen, refer to "8. Checking procedure of Error History".

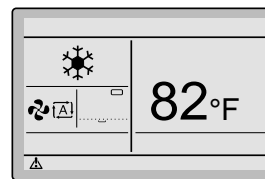
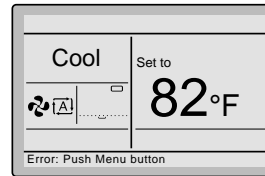

| User interface display | Description |
|--|---|
| No display | <ul style="list-style-type: none"> • Power outage, power voltage failure or open-phase • Wrong wiring (between indoor and outdoor units) • Indoor PCB assembly failure • User interface wiring disconnection • User interface failure • Blown fuse (outdoor unit) |
| Display "Checking the connection Please stand by" is shown.* | <ul style="list-style-type: none"> • Indoor PCB assembly failure • Wrong wiring (between indoor and outdoor units) |

* Though "Checking the connection Please stand by" is displayed for up to 180 seconds after powering on, this does not mean there is a failure. (Determine after 180 seconds if error code "U5" is displayed.)

Checking procedure of Error History

8. Checking procedure of Error History

8-1 Press and hold the Cancel button for 4 seconds or longer in the Basic screen. The Service Settings menu is displayed.

<Basic screen>

8-1

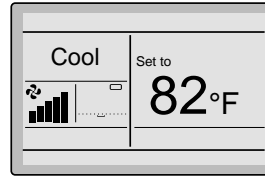

Press and hold the Cancel button for 4 seconds or longer while the backlight is lit.



8-2 Select **Error History** and press the Menu/Enter button. The Error History menu is displayed.

<Service Settings>

8-2

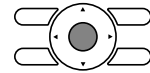
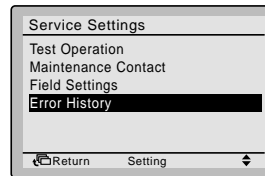

Press the Menu/Enter button.



8-3 Select **RC Error History** and press the Menu/Enter button. The error codes can be confirmed in the RC Error History screen.

8-3

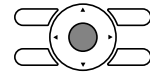
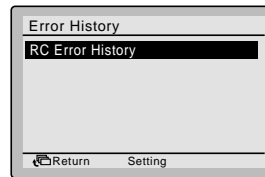

Press the Menu/Enter button.



8-4 In the RC Error History screen the last 10 items are displayed in order.

8-4

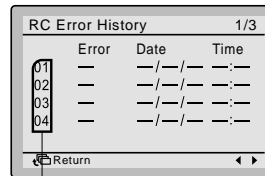

8-5

8-5 Press the Cancel button in the RC Error History screen 3 times. The Basic screen returns.

Latest record

Registration method of the Maintenance Contact information

9. Registration method of the Maintenance Contact information

- Registration of the service contact information.

9-1 Press and hold the Cancel button for 4 seconds or longer in the Basic screen. The Service Settings menu is displayed.

9-2 Select **Maintenance Contact** and press the Menu/Enter button. The "Maintenance Contact" screen is displayed.

9-3 Select **Maintenance Contact** and press the Menu/Enter button.

9-4 Enter the telephone number by using the ▲▼ (Up/Down) buttons. Enter from the left to the right and blank digits should be left as " - ".

9-5 Press the Menu/Enter button. The setting confirmation screen is displayed.

9-6 Select **Yes** and press the Menu/Enter button. The settings are entered and the Service Settings menu returns.

9-7 Press the Cancel button once. The Basic screen returns.

9-1 **<Basic screen>**

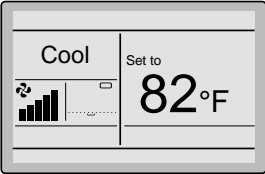

Press and hold the Cancel button for 4 seconds or longer while backlight is lit.

9-2 **<Service Settings>**

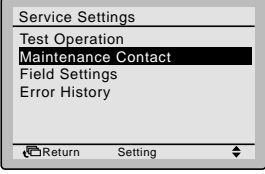

Press the Menu/Enter button.

9-3

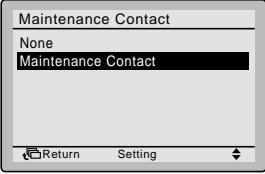

Press the Menu/Enter button.

9-4

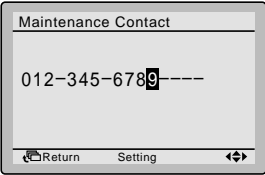

Press the Menu/Enter button.

9-5

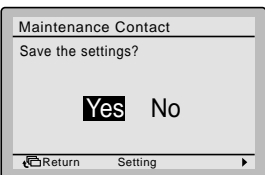

Press the Menu/Enter button.

<Service Settings>

10. Confirmation of registered details

10-1 Press the Menu/Enter button in the Basic screen. The Main menu is displayed.

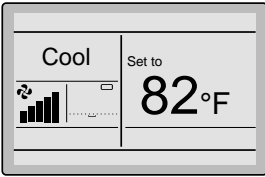
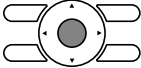

10-1 **<Basic screen>**

Press the Menu/Enter button.

10-2 Select **Maintenance Information** and press the Menu/Enter button. The "Maintenance Information" screen is displayed.

10-2 **<Main menu>**

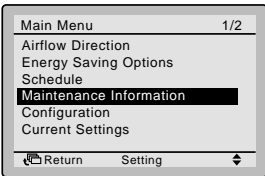
Press the Menu/Enter button.

10-3 Confirm that the contact information is entered correctly.

10-3 **Maintenance Information**

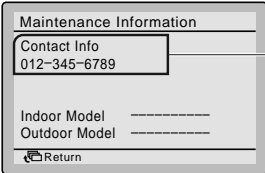

The registered details are displayed.

10-4 Press the Cancel button twice. The Basic screen returns.

Clock & Calendar

11. Clock & Calendar

11-1 Press the Menu/Enter button in the Basic screen. The Main menu is displayed.

11-1

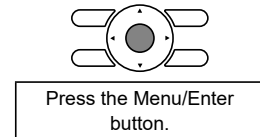
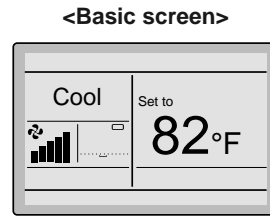

11-2 Select **Clock & Calendar** and press the Menu/Enter button. The "Clock & Calendar" menu is displayed.

11-2

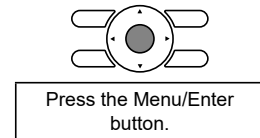
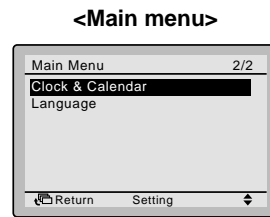

11-3 Select **Date & Time** and press the Menu/Enter button. The "Date & Time" screen is displayed.

11-3

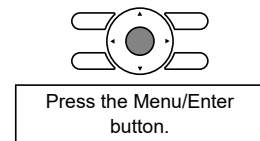
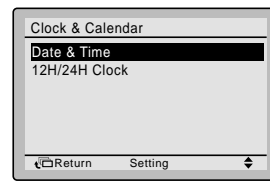

11-4 Select the "Year", "Month", "Day" and time by using the ◀▶ (Left/Right) buttons and change the value by using the ▲▼ (Up/Down) buttons. When the buttons are pressed and held, the values change continuously.

11-4

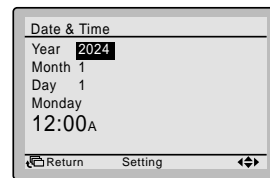

11-5

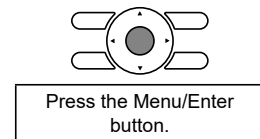

11-5 Press the Menu/Enter button. The confirmation screen is displayed.

NOTE

The day of the week is set automatically.

11-6 Select **Yes** and press the Menu/Enter button. The settings are confirmed and the Basic screen returns.

11-6

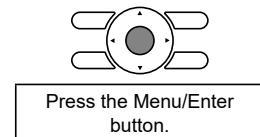
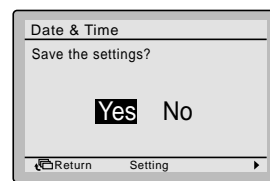

<Basic screen>

NOTE

If a power outage lasts longer than 48 hours, the time is reset and needs to be set again.

12. Language

12-1 Press the Menu/Enter button in the Basic screen. The Main menu is displayed.

12-1

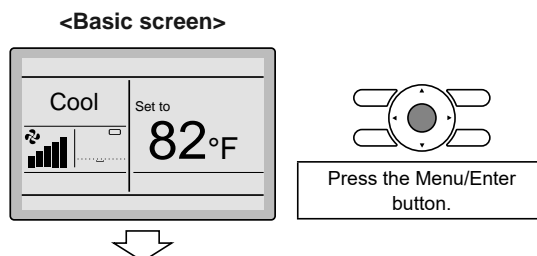

12-2 Select **Language** and press the Menu/Enter button. The "Language" screen is displayed.

12-2

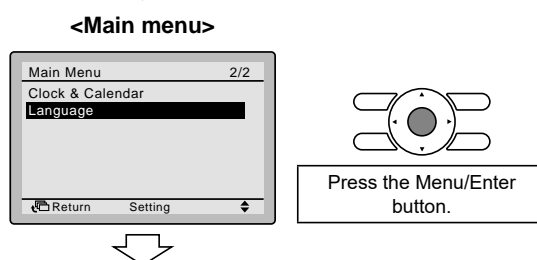

12-3 Press the ▲▼ (Up/Down) buttons to select the preferred language (English, French or Spanish) and press the Menu/Enter button. The settings are confirmed and the Basic screen returns.

12-3

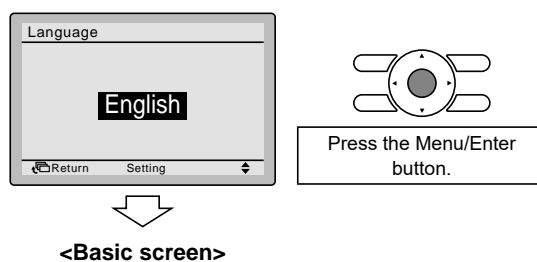

Prohibit Buttons

13. Prohibit Buttons

- Restriction of the number of operable buttons.

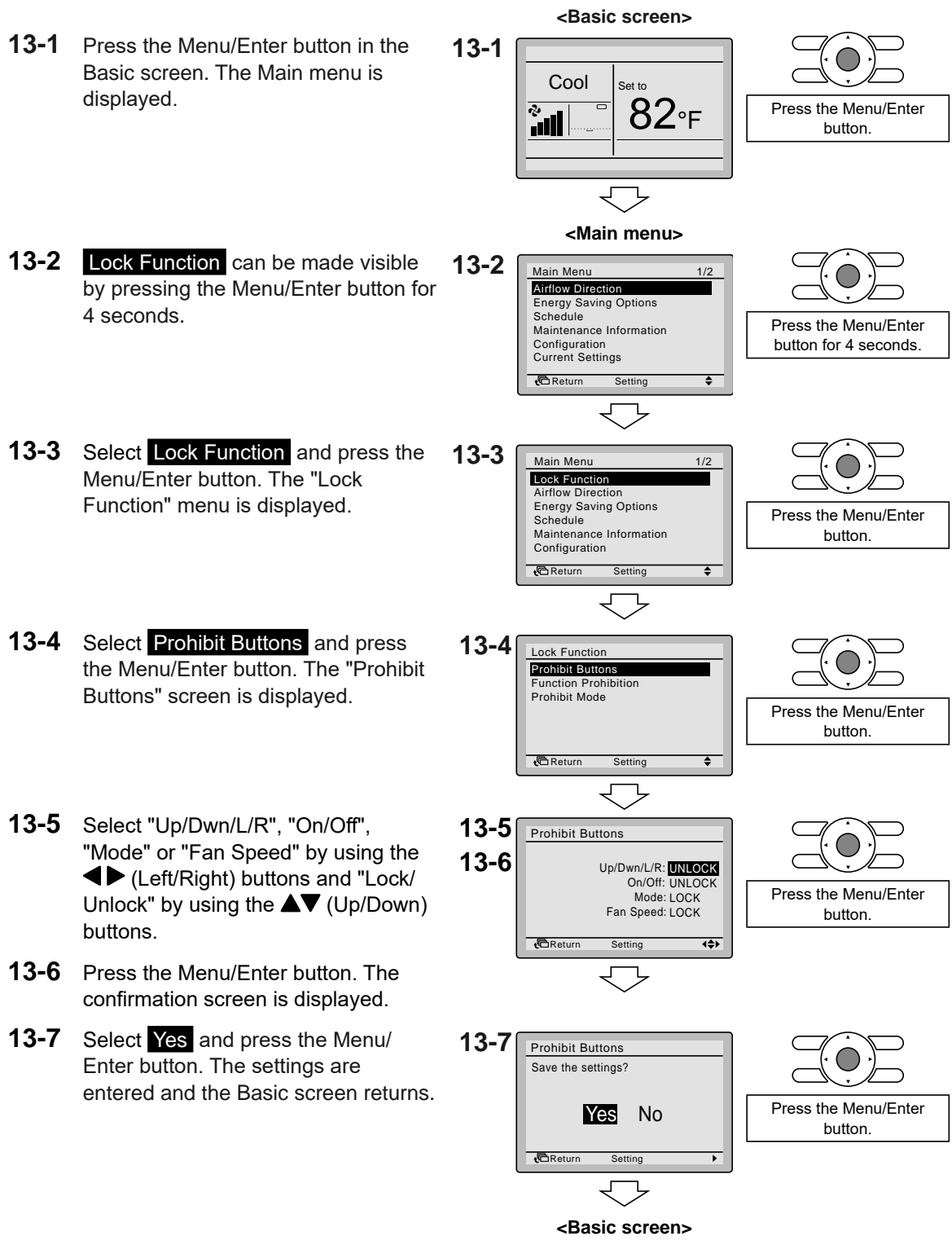

14. Function Prohibition

- Restriction of the number of operable functions.

14-1 Press the Menu/Enter button in the Basic screen. The Main menu is displayed.

<Basic screen>

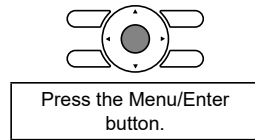
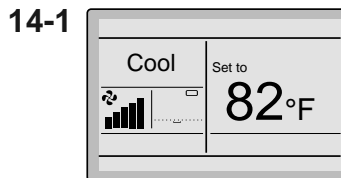

14-2 **Lock Function** can be made visible by pressing the Menu/Enter button for 4 seconds.

<Main menu>

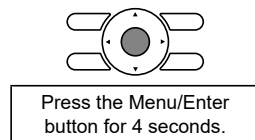
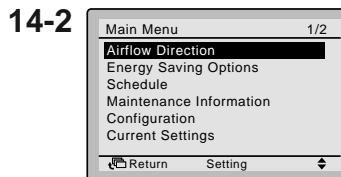

14-3 Select **Lock Function** and press the Menu/Enter button. The "Lock Function" menu is displayed.

14-3

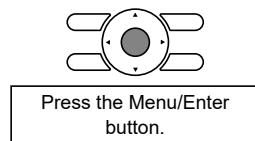
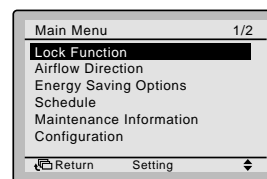

14-4 Select **Function Prohibition** and press the Menu/Enter button. The "Function Prohibition" screen is displayed.

14-4

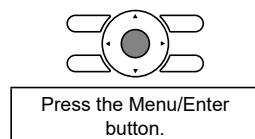
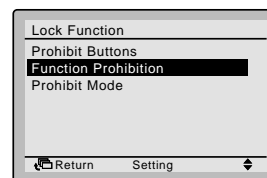

14-5 Select the desired function by using the ◀▶ (Left/Right) buttons and "Lock/Unlock" by using the ▲▼ (Up/Down) buttons.

14-5

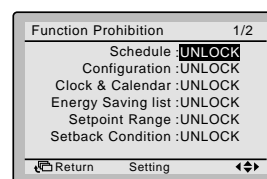

14-6

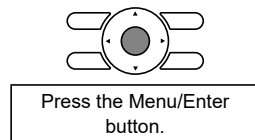

14-6 Press the Menu/Enter button. The confirmation screen is displayed.

Prohibit Mode

14-7 Select **Yes** and press the Menu/Enter button. The settings are entered and the Basic screen returns.

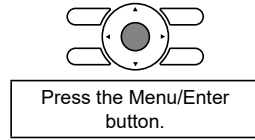
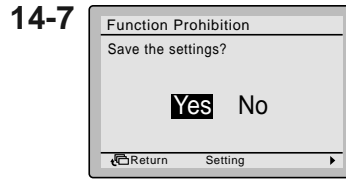

<Basic screen>

NOTE

- When a function is prohibited, the  icon will be displayed next to the function.

15. Prohibit Mode

- Restriction of the number of operable modes.

15-1 Press the Menu/Enter button in the Basic screen. The Main menu is displayed.

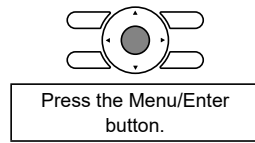
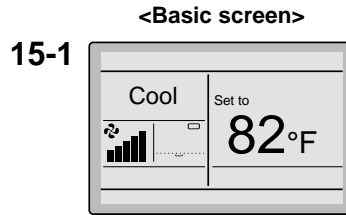

15-2 **Lock Function** can be made visible by pressing the Menu/Enter button for 4 seconds.

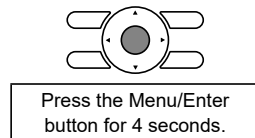
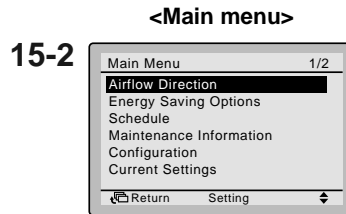

15-3 Select **Lock Function** and press the Menu/Enter button. The "Lock Function" menu is displayed.

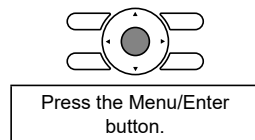
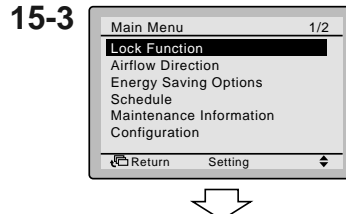

Prohibit Mode

15-4 Select **Prohibit Mode** and press the Menu/Enter button. The "Prohibit Mode" screen is displayed.

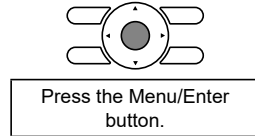
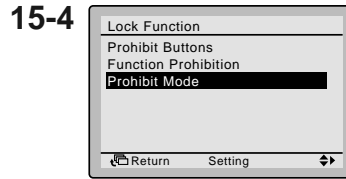

15-5 Select "Fan", "Cool", "Heat", "Auto" or "Dry" using the ◀▶ (Left/Right) buttons and "Enable/Disable" the selected mode by using the ▲▼ (Up/ Down) buttons.

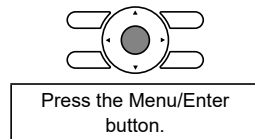
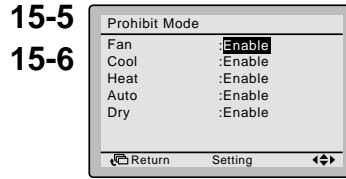

15-6 Press the Menu/Enter button. The confirmation screen is displayed.

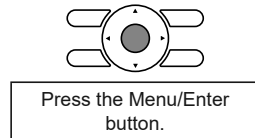
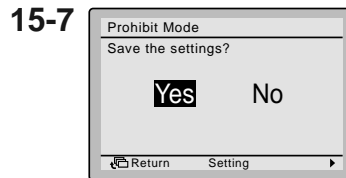

15-7 Select **Yes** and press the Menu/Enter button. The settings are confirmed and the Basic screen returns.

<Basic screen>

NOTE

- When the currently active mode is locked, this mode will still be active upon returning to the Basic screen. Only when the mode is changed, the disabled mode will not be available anymore. When all modes are locked, it is not possible to change to another mode other than the currently active mode.

2.2 <BRC073A6> Wired Remote Controller (Operation)



Safety Considerations

The original instructions are written in English. All other languages are translations of the original instructions.





This appliance is not intended to be used by persons, including children, with reduced physical, sensory or mental capabilities or lack of experience and knowledge, unless they are supervised or have been given instructions on how to use the appliance by a person responsible for their safety. Children should be supervised to ensure that they do not play with the appliance.

Please read these Safety Considerations carefully before installing the remote controller.





- This manual classifies the precautions into WARNING and CAUTION. They both contain important information regarding safety. Be sure to follow all the precautions below.

| | |
|--|---|
|  WARNING | Failure to follow these instructions properly may result in personal injury or loss of life. |
|  CAUTION | Failure to observe these instructions properly may result in property damage or personal injury, which may be serious depending on the circumstances. |







- The following pictograms are used in this manual.

| | | | |
|---|--|---|---------------------------------------|
|  | Never do. |  | Always follow the instructions given. |
|  | Be sure to ground the unit. |  | Absolutely keep wet hands away. |
|  | Absolutely keep water and moisture away. | | |







■ About Remote Controller

|  WARNING | |
|--|---|
|  | <ul style="list-style-type: none"> • Do not install the remote controller by yourself. Improper installation may result in electric shocks or fire. Consult your Daikin dealer. |
|  | <ul style="list-style-type: none"> • Do not modify or repair the remote controller. This may result in electric shocks or fire. Consult your Daikin dealer. |
|  | <ul style="list-style-type: none"> • Do not relocate or reinstall the remote controller by yourself. Improper installation may result in electric shocks or fire. Consult your Daikin dealer. |
|  | <ul style="list-style-type: none"> • Do not use flammable materials (e.g., hair spray or insecticide) near the product. Do not clean the product with organic solvents such as paint thinner. The use of organic solvents may cause crack damage to the product, electric shocks or fire. |











Items to be Strictly Observed

|  CAUTION | |
|--|--|
|  | <ul style="list-style-type: none"> • Do not play with the unit or its remote controller. Accidental operation by a child may result in impairment of bodily functions and harm health. |
|  | <ul style="list-style-type: none"> • Never disassemble the remote controller. Touching the interior parts may result in electric shocks or fire. Consult your Daikin dealer or authorized contractor for internal inspections and adjustments. |
|  | <ul style="list-style-type: none"> • To avoid electric shocks, do not operate with wet hands. |
|  | <ul style="list-style-type: none"> • Do not wash the remote controller. Doing so may cause electric leakage and result in electric shocks or fire. |
|  | <ul style="list-style-type: none"> • Do not leave the remote controller wherever there is a risk of wetting. If water gets into the remote controller there is a risk of electrical leakage and damage to electronic components. |















■ Indoor Unit and Outdoor Unit

|  WARNING | |
|--|---|
|  | <ul style="list-style-type: none"> • Be aware that prolonged, direct exposure to cool or warm air from the air conditioner or to air that is too cold or too warm can be harmful to your physical condition and health. |
|  | <ul style="list-style-type: none"> • Do not place objects, including rods, your fingers, etc. in the air inlet or outlet. Injury may result due to contact with the air conditioner's high-speed fan blades. |
|  | <ul style="list-style-type: none"> • Contact professional personnel about attachment of accessories and be sure to use only accessories specified by the manufacturer. If a defect results from your own workmanship, it may result in water leaks, electric shock or fire. |
|  | <ul style="list-style-type: none"> • Do not use the product in atmospheres contaminated with oil vapor, such as cooking oil or machine oil vapor. Oil vapor may cause crack damage, electric shocks or fire. |
|  | <ul style="list-style-type: none"> • Do not use the product in places with excessive oily smoke, such as cooking rooms or in places with flammable gas, corrosive gas or metal dust. Using the product in such places may cause fire or product failures. |











Items to be Strictly Observed

|  WARNING | |
|--|--|
|  | <ul style="list-style-type: none"> • Beware of fire in case of refrigerant leakage. If the air conditioner is not operating correctly, i.e. not generating cool or warm air, refrigerant leakage could be the cause. Consult your dealer for assistance. The refrigerant within the air conditioner is safe and normally does not leak. However, in the event of a leakage, contact with a naked burner, heater or cooker may result in generation of noxious gas. Do not longer use the air conditioner until a qualified service person confirms that the leakage has been repaired. |
|  | <ul style="list-style-type: none"> • In the case of using a load breaker provided with a fuse, make sure that the capacity of the fuse is correct. Use of an ordinary conductive wire may cause malfunctions or fire. |
|  | <ul style="list-style-type: none"> • Do not use the power supply breaker to start or stop the air conditioner. Otherwise, fire or water leakage may result. Furthermore, the fan will rotate abruptly if power failure compensation is enabled, which may result in injury. |
|  | <ul style="list-style-type: none"> • Be sure to ground the unit. Do not ground the unit to a utility pipe, lightning conductor or telephone ground lead. Imperfect grounding may result in electric shocks or fire. A high surge current from lightning or other sources may cause damage to the air conditioner. |
|  | <ul style="list-style-type: none"> • When the air conditioner is malfunctioning (giving off a burning odor, etc). turn off the power and contact your local dealer. Continued operation under such circumstances may result in a failure, electric shocks or fire hazards. |
|  | <ul style="list-style-type: none"> • Consult your local dealer regarding what to do in case of refrigerant leakage. When the air conditioner is to be installed in a small room, it is necessary to take proper measures so that the amount of any leaked refrigerant does not exceed the concentration limit in the event of a leakage. Otherwise, this may lead to an accident due to oxygen depletion. |
|  | <ul style="list-style-type: none"> • Be sure to install a ground leakage breaker. Failure to install a ground leakage breaker may result in electric shocks or fire. |
|  | <ul style="list-style-type: none"> • Consult the dealer if the air conditioner submerges owing to a natural disaster such as a flood or typhoon. Do not operate the air conditioner in that case or otherwise a malfunction, electric shock or fire may result. |
|  | <ul style="list-style-type: none"> • Be sure to use a dedicated power supply for the air conditioner. The use of any other power supply may cause heat generation, fire or product failures. |

Items to be Strictly Observed

|  CAUTION | |
|--|---|
|  | <ul style="list-style-type: none"> • After prolonged use, check the unit stand and its mounts for damage. If left in a damaged condition, the unit may fall and cause injury. |
|  | <ul style="list-style-type: none"> • Do not allow a child to mount on the outdoor unit or avoid placing any object on it. Falling or tumbling may result in injury. |
|  | <ul style="list-style-type: none"> • Do not block air inlets nor outlets. Impaired airflow may result in insufficient performance or trouble. |
|  | <ul style="list-style-type: none"> • To avoid injury, do not touch the air inlet or aluminium fins of the unit. |
|  | <ul style="list-style-type: none"> • Do not remove the outdoor unit's fan guard. The guard protects against the unit's high speed fan, which may cause injury. |
|  | <ul style="list-style-type: none"> • Do not place objects that are susceptible to moisture directly beneath the indoor or outdoor units. Under certain conditions, condensation on the main unit or refrigerant pipes, air filter dirt or drain blockage may cause dripping, resulting in fouling or failure of the object concerned. |
|  | <ul style="list-style-type: none"> • Do not place water containers (flower vases, etc). on the unit, as this may result in electric shocks or fire. |
|  | <ul style="list-style-type: none"> • Do not use the air conditioner for purposes other than those for which it is intended. Do not use the air conditioner for cooling precision instruments, food, plants, animals or works of art as this may adversely affect the performance, quality and/or longevity of the object concerned. |
|  | <ul style="list-style-type: none"> • Do not place appliances that produce naked flames in places exposed to the airflow from the unit as this may impair combustion of the burner. |
|  | <ul style="list-style-type: none"> • Do not place heaters directly below the unit as resulting heat can cause deformation. |
|  | <ul style="list-style-type: none"> • Be sure that children, plants or animals are not exposed directly to airflow from the unit as adverse effects may ensue. |
|  | <ul style="list-style-type: none"> • Do not put flammable containers, such as spray cans, within 1 m from the blow-off mouth. The containers may explode because the warm air output of the indoor or outdoor unit will affect them. |
|  | <ul style="list-style-type: none"> • Do not install the air conditioner at any place where there is a danger of flammable gas leakage. In the event of a gas leakage, build-up of gas near the air conditioner may result in fire hazards. |

Items to be Strictly Observed

|  CAUTION | |
|--|--|
|  | <ul style="list-style-type: none"> • Do not sit or stand on any unstable base at the time of operating or maintaining the air conditioner. The base may topple down and injury may occur. |
|  | <ul style="list-style-type: none"> • Do not touch the motor when replacing the filter. The motor can be very hot which may result in burns. |
|  | <ul style="list-style-type: none"> • Do not wash the air conditioner with water as this may result in electric shocks or fire. |
|  | <ul style="list-style-type: none"> • Perform ventilation from time to time. Be careful when using the air conditioner with other heating equipment. Insufficient ventilation may result in oxygen deficiency. |
|  | <ul style="list-style-type: none"> • Always stop the operation of the air conditioner and turn OFF the power supply breaker when cleaning. Failure to do so may result in an electric shock or injury. |
|  | <ul style="list-style-type: none"> • Do not wash the interior of the indoor and outdoor units by yourself. Always consult your Daikin dealer. The use of an incorrect washing method or incorrect detergent may damage the resin parts of the indoor unit or cause water leakage. Moreover, malfunctions, smoke generation or ignition may result if the electric parts or the motor in the indoor unit come in contact with a detergent or water. |
|  | <ul style="list-style-type: none"> • Do not place objects in direct proximity of the outdoor unit and do not let leaves and other debris accumulate around the unit. Leaves are a hotbed for small animals which can enter the unit. Once in the unit, such animals can cause malfunctions, smoke or fire when making contact with electrical parts. |
|  | <ul style="list-style-type: none"> • Fix the units securely. If the units are not mounted securely, the units may fall or topple and result in personal injury. |
|  | <ul style="list-style-type: none"> • Arrange the drain to ensure complete drainage. If proper drainage from the outdoor drain pipe does not occur during air conditioner operation, there could be a blockage due to dirt and debris build-up in the pipe. This may result in water leakage from the indoor unit. Under these circumstances, stop the air conditioner operation and consult your dealer for assistance. |

Names and Functions

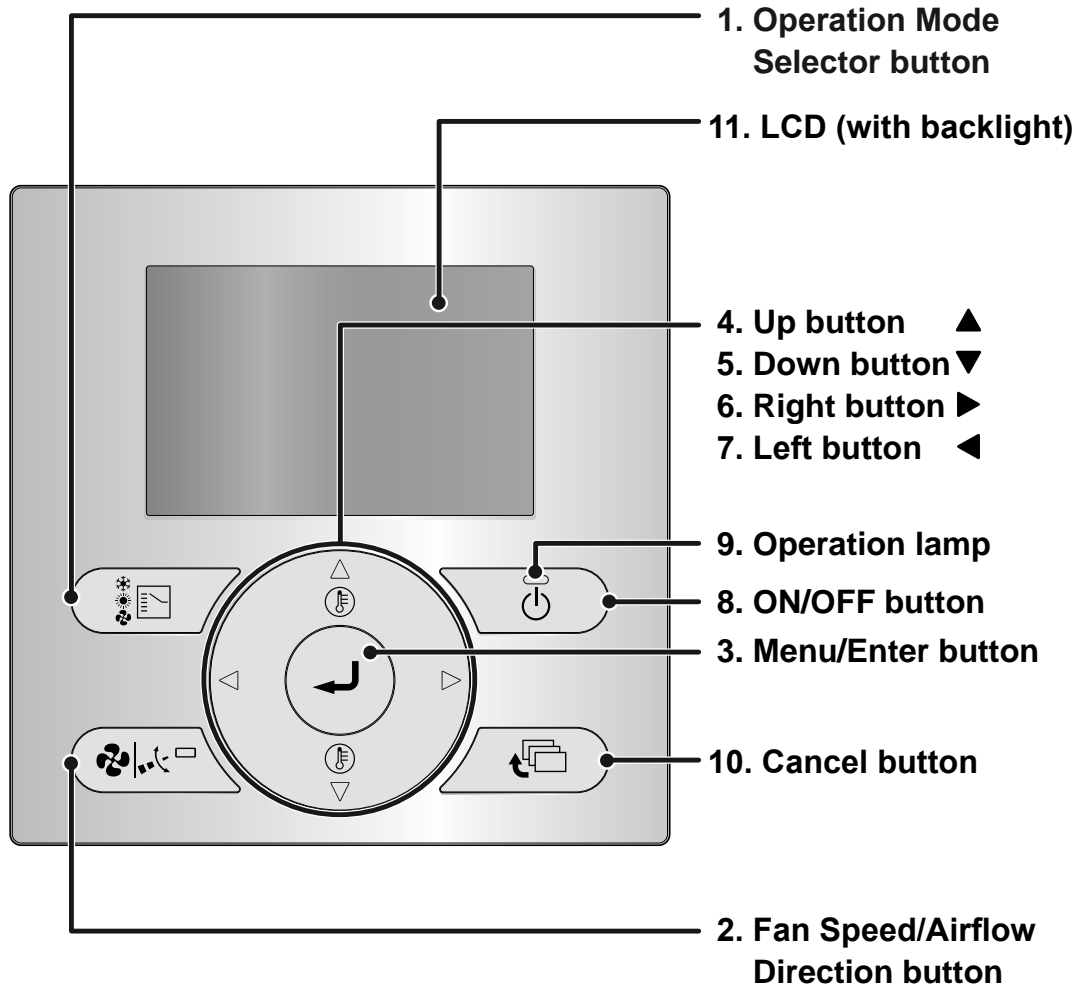

Functions other than the basic operation items (i.e., ON/OFF, operation mode selection, fan speed, up/down direction, and temperature setting) are set from the menu screen.

NOTE

- Do not install the remote controller in places exposed to direct sunlight. Otherwise, the LCD may become discolored and nothing may be displayed.
- Do not pull or twist the remote controller cord. Otherwise, the remote controller may malfunction.
- Do not press the buttons on the remote controller with objects with sharp ends. Otherwise, the remote controller may be damaged or malfunction.

1. Operation Mode Selector button

- Press this button to select the operation mode of your preference. (See "Cool/Heat/Fan/Dry/Auto Operation" on page 12)
- Available modes may vary with the connected model.

2. Fan Speed/Airflow Direction button

- Used to change the fan speed and airflow direction. (See "Cool/Heat/Fan/Dry/Auto Operation" on page 12)
- Available fan speeds and airflow directions may vary with the connected model.

3. Menu/Enter button

- This button is enabled by default. To disable, refer to "Enable/disable the Menu/Enter and Cancel button" on page 11.
- Used to display the Main Menu or enter the selected item (See "Main Menu Items Overview" on page 19).

4. Up button ▲

- Used to raise the set temperature.
- The next item on the upper side will be highlighted.
(Keep pressing the button to cycle through the values or items).
- Used to change the selected item.

5. Down button ▼

- Used to lower the set temperature.
- The next item on the lower side will be highlighted.
(Keep pressing the button to cycle through the values or items).
- Used to change the selected item.

6. Right button ►

- Used to highlight the next items on the right-hand side.
- The display contents are changed to the next screen.

7. Left button ◀

- Used to highlight the next items on the left-hand side.
- The display contents are changed to the previous screen.

8. ON/OFF button

- Press to start or stop the air conditioner.

9. Operation lamp (Green)

- This lamp lights up during operation.
- This lamp is not lit when the unit operation is OFF.
- This lamp blinks if an error or mode conflict occurs.

10. Cancel button

- This button is enabled by default. To disable, refer to "Enable/disable the Menu/Enter and Cancel button" on page 11.
- Used to return to the previous screen.

11. LCD (with backlight)

- The backlight will be lit for approximately 30 seconds when one of the buttons is pressed.
- The actions linked to the buttons, except for the ON/OFF button, are not carried out when the backlight is not lit.

Names and Functions

Liquid Crystal Display

- There are four display methods for the liquid crystal display (LCD) available. The Standard display, which is used by default, and the Detailed display. There is also the possibility to use only Icon or Icon and Text mode (see the Installation manual).
- To change the active display method, select the desired display method in the Display Method screen (See "Display" on page 34).
- The displayed contents on the screen may vary with the operation mode of the connected models. (E.g.: The following display will appear when the air conditioner is in heating operation).

Standard display

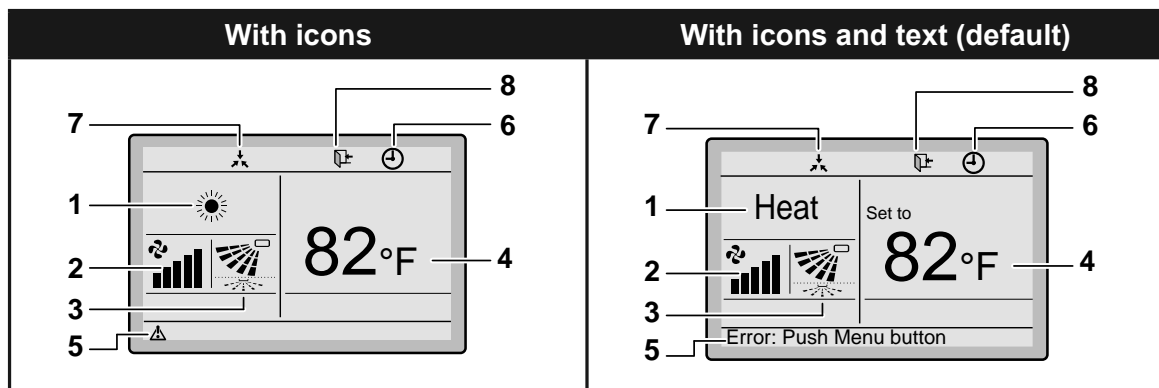





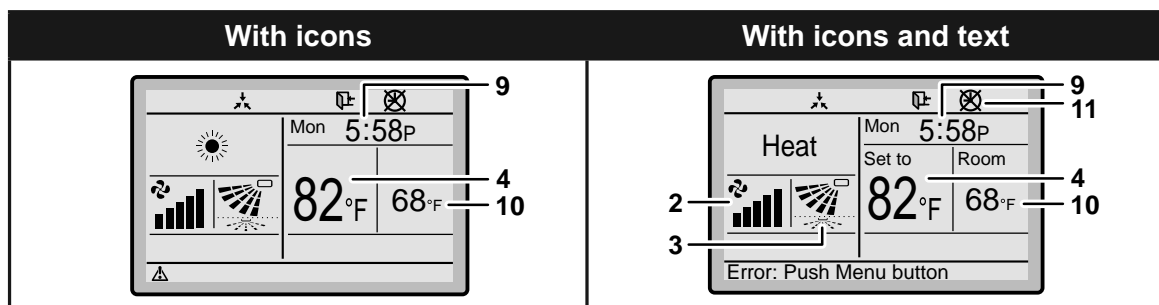

Detailed display

- The clock and Detailed selection items appear on the Detailed display in addition to the items appearing on the Standard display.



1. Operation mode

- Indicates the current operation mode.

| Operation Mode | | |
|---|---|---|
| Cool | Heat | Auto (Heat) |
|  |  |  |
| Fan | Dry | Auto (Cool) |
|  |  |  |

2. Fan speed

(See "Cool/Heat/Fan/Dry/Auto Operation" on page 12)

- Indicates the fan speed that is set for the air conditioner.
- The fan speed will not be displayed if the air conditioner does not have the fan speed control function.

3. Airflow direction

- Displayed only when the air conditioner is in operation.
- Indicates the airflow direction that is set for the air conditioner.
- The possible directions depend on the indoor unit.

4. Set/Setback temperature display

(See "Setback" on page 17)

- When the unit is turned ON, the temperature that is set for the air conditioner is displayed.
- When the unit is turned OFF and Setback is disabled, the temperature that is set for the air conditioner is displayed.
- When the unit is turned OFF and Setback is enabled, the temperature that is set for the setback function is displayed in smaller digits.

5. Error "△"

(See "Error Code Display" on page 42)

- Indicates a unit error.

6. Timer enabled "☺"

(See "OFF Timer" on page 27 and "Schedule" on page 28)

- Indicates that the schedule timer or the OFF timer is enabled.

7. Under Centralised control "✱"

- Indicates that the air conditioner is under the management of central control equipment (optional accessories) and the operation of the system through the remote controller is prohibited.

8. Setback "⏮"

(See "Setback" on page 17)

- The setback icon flashes when the unit is turned on under the setback control.

9. Clock (12/24 hours real time clock)

(See "Clock & Calendar" on page 38)

- Indicates that the clock is set.
- If the clock is not set, "-- : --" will be displayed.

10. Detailed selection

(See "Display Mode" on page 34)

- Displayed when the detailed display mode is selected.
- No detailed items are selected by default.

11. Timer problem "⌛"

- Indicates that the clock needs to be set again.
- The schedule timer function will not work unless the clock is set again.

Basic Operation Method

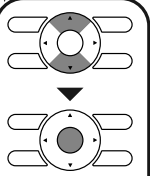
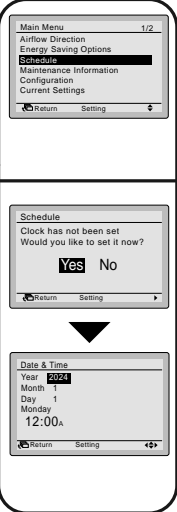
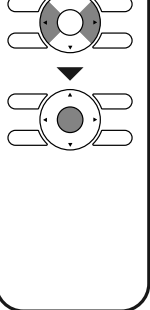
| Remote Controller Functions | Operation procedure | Button display |
|--|--|--|
| Operation Method | | |
| <p>Screen display 1</p> <p>Screens that will be displayed on the remote controller.</p> | <ul style="list-style-type: none"> • Display the Main Menu. (See "Manipulating the Main Menu" on page 21). • Press the ▼▲ (Up/Down) buttons to select Schedule and press the Menu/Enter button. |  |
| <p>2</p>  | <ul style="list-style-type: none"> • Press the ◀▶ (Left/Right) buttons to select Yes and press the Menu/Enter button. • The Date & Time screen will appear. • Set the current year, month, day, and time. (See "Clock & Calendar" on page 38). <p>Note</p> <ul style="list-style-type: none"> • Before setting the schedule, the clock must be set. • If the clock has not been set, a screen like the one on the left will appear. |  |

Enable/disable the Menu/Enter and Cancel button

Operation Method By default, the Menu/Enter and Cancel button are enabled.

1

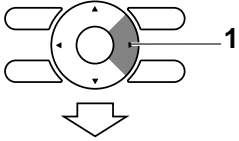

- To enable/disable the Menu/Enter and Cancel button, keep the ► (Right) button pressed in the Basic Screen.

2

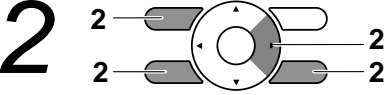

- Press the 3 keys simultaneously while keeping the ► (Right) button pressed.

Cool/Heat/Fan/Dry/Auto Operation

Operation Method

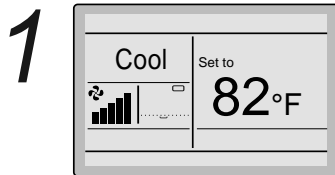

- 1 Press the Operation Mode Selector button several times until the desired mode (Cooling, Heating, Fan Only, Dry or Auto) is selected.

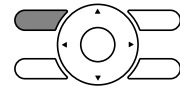

Note

- Unavailable operation modes are not displayed.
- Only Cooling, Dry or Fan Only mode can be selected if the air conditioner is a cooling-only model.



- 2 Press the ON/OFF button. The Operation lamp (green) will be lit and the air conditioner will start operating.

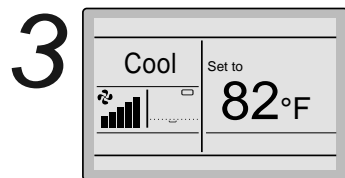

- 3 The set temperature will increase by 1°F when the ▲ (Up) button is pressed and decrease by 1°F when the ▼ (Down) button is pressed.

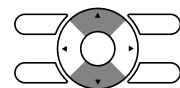

Note

Temperature settings are not possible while in Dry or Fan Only mode.

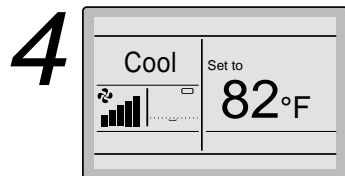

- 4 To change the fan speed or airflow direction, press the Fan Speed/Airflow Direction button.

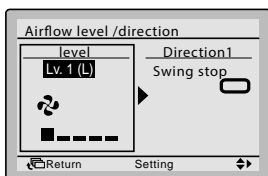

- To select air volume or airflow direction setting, press the ◀▶ buttons.
- Press the ▲▼ (Up/Down) buttons to select the desired level or position.

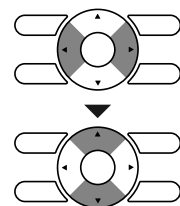

Basic Operation Method

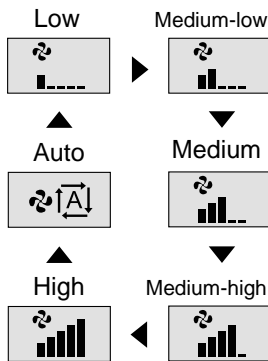

Note

- The air conditioner may be in automatic fan speed control for mechanical protection purposes.
- The air conditioner may be in automatic fan speed control according to the room temperature.
- The fan may stop operating, which is not a failure.
- It may take time until fan speed changes are actually carried out.
- In Auto fan speed, the fan speed is adjusted automatically according to the setpoint and indoor temperature.

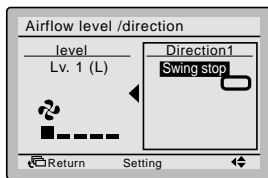

- With airflow direction selected, select the desired airflow direction from **Swing** or **Swing stop** using the ▲▼ (Up/Down) buttons.

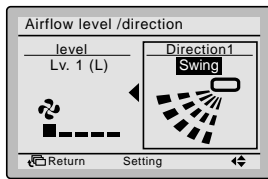

Airflow direction setting (up/down)

Note

- The airflow directions appear on the screen as follows:



Up/down direction



Left/right direction

- Selecting **Swing** will cause the airflow direction blades to swing back and forth.
- When you select **Swing stop**, the airflow direction blades stay in the position of when you press the Menu/Enter button.

Note

- To change the left/right airflow direction, refer to "Change the Airflow direction" on page 22.

Basic Operation Method

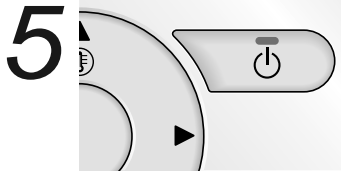

- When the ON/OFF button is pressed again, the air conditioner will stop operating and the Operation lamp will turn OFF.

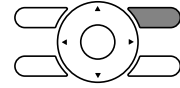
**Note**

- When the system is stopped while in heating operation, the fan will continue to operate for approximately 1 minute in order to eliminate the residual heat in the indoor unit.

Basic Operation Method

Characteristics of Cooling Operation

- When the outdoor air temperature is high, it takes some time until the room temperature reaches the set temperature.

Characteristics of Heating Operation

Starting operation

- Heating operation generally requires a longer time to attain the set temperature compared with cooling operation.
It is recommended to start operating the air conditioner in advance by using the timer.

Perform the following operation in order to prevent the degradation of the heating capability or cold drafts.

Defrost operation

- The air conditioner will automatically go into defrost operation to prevent frost accumulation at the outdoor unit which results in loss of the heating capacity.
- The air conditioner will return to normal operation after approximately 4 to 12 minutes.
- During defrost mode the temperature near the indoor room temp is displayed. This may be affected by the location of the unit.

Outdoor temperature and heating capability

- The heating capacity of the air conditioner will drop when the outdoor temperature decreases.
If the heating effect is insufficient, it is recommended to use another heating appliance in combination with the air conditioner. (When a combustion appliance is used, ventilate the room regularly).
Do not use the heating appliance in places where the heating appliance is exposed to the airflow of the air conditioner.
- The air conditioner is a hot air circulation type. Therefore, it takes some time to warm up the room after the air conditioner starts operating.
The indoor fan will automatically operate until the indoor temperature of the system rises to a certain level.
- If hot air stays around the ceiling and your feet feel cold, a circulator is recommended.
For details, consult your Daikin dealer.

Program Dry Operation

Preparation

- The dry mode may not be selected if the remote controller has no eligibility to select cooling/heating mode.

Operation Method

1



- Press the Operation Mode Selector button several times until Dry mode is selected.

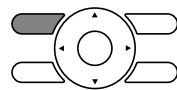

Note

Dry mode may not be available depending on the type of indoor unit.

2

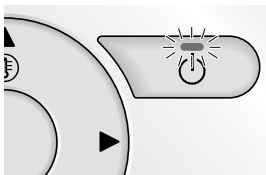

- Press the ON/OFF button. The Operation lamp will be lit and the air conditioner will start operating.

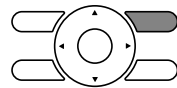

Note

The air conditioner is in automatic temperature and fan speed control. Therefore, the temperature or fan speed cannot be changed while the air conditioner is in operation.

3

- To set the airflow direction, see "Airflow Direction" on page 22.

4



- When the ON/OFF button is pressed again, the air conditioner will stop operating and the Operation lamp will turn OFF.

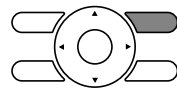

Note

To prevent water leakage or system failure, do not turn OFF the power soon after the air conditioner stops operating. Be sure to wait at least 5 minutes so that the drain pump finishes discharging the residual water from the indoor unit.

Basic Operation Method

Characteristics of Dry Operation

In Dry operation, the air humidity will be lowered by intermittently turning the air conditioner ON in cooling and OFF again to minimize the temperature decrease.

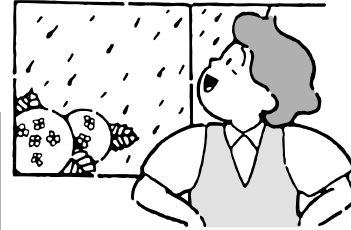

Note

- The temperature and fan speed are controlled automatically and cannot be controlled by the remote controller.
- Dry operation will not function if the room temperature is too low.

Setback

The Setback function will maintain the room temperature in a specific range when the remote controller is turned OFF. This is done by temporarily starting the air conditioner that was previously turned OFF by the user, the schedule function or the OFF timer.

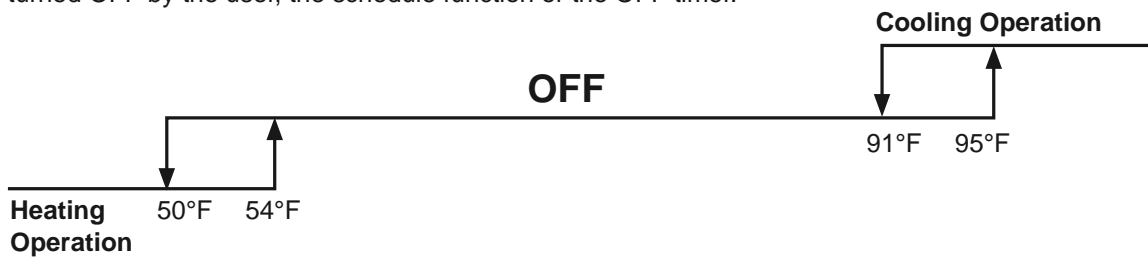

For example:

- [Setback setpoint temperature: cool 95°F, heat 50°F]
- [Recovery differential: cool -4°F, heat +4°F]

- If the room temperature drops below 50°F, heating is started automatically. If after half an hour the temperature increases to 54°F or above, the controller returns to its original state.
- If the room temperature goes above 95°F, cooling is started automatically. If after half an hour the temperature drops to 91°F or below, the controller returns to its original state.

Note

- This function is disabled by default. This function can only be enabled/disabled in the Energy Saving List (See "Energy Saving Options" on page 23).
- The differential can be adjusted in the Setback Condition menu (See "Setback Condition" on page 25).
- The setback temperature can be set while the unit is turned off on the Basic Screen or set in the schedule.
- Setback will turn the unit ON for at least 30 minutes unless the setback temperature setpoint is changed or the unit is turned ON with the ON/OFF button.
- When setback turns the air conditioner ON while in Auto mode, the remote controller switches to Cooling or Heating only, depending on what is appropriate, and only the respective setback temperature setpoint is shown.
- The temperature is measured inside the air conditioner unit (when the unit is switched OFF). As there is no actual air flow, the measured temperature inside the air conditioner unit can deviate (up to 6°F) from the actual room temperature.

Setback should not be enabled when a centralised controller is connected via the KRP928 Interface adapter for Room Air Conditioner.

Operation Method

1

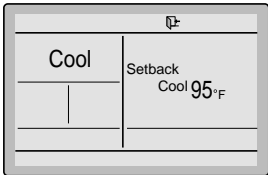

The setback icon "⏸" flashes when the unit is turned ON under the setback control.

The fan speed cannot be changed when setback is active and, as a result, the fan speed is not visible.

The airflow direction can only be changed through the menu when setback is active.

Key Lock

Operation Method

Disable the use of all buttons.

1

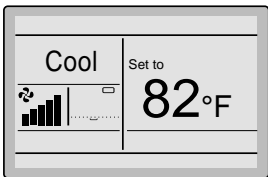

- Press the Menu/Enter button for at least 4 seconds. (During backlight lit)

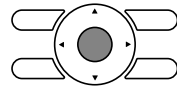

2

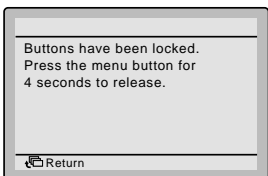

- All buttons are disabled when the keys are locked.
- When one of the buttons is pressed, the message on the left is displayed.

3

- To cancel the key lock, continue pressing the Menu/Enter button for at least 4 seconds. (During backlight lit)

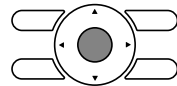

Quick Reference of Main Menu Items

■ Main Menu Items Overview

Note

- The available items may vary with the connected model.
- Only the available items will appear in the menu.

| Setting and display items | | Description | Reference page |
|--|-------------------------------|--|----------------|
| Airflow Direction | | Change the airflow direction. <ul style="list-style-type: none"> • The airflow direction blades can be automatically operated up and down and left and right. • There are swing or swing stop directions. • This function is not available on all models. | 22 |
| Energy Saving Options⁽¹⁾ | Energy Saving List | Enable or disable the "Energy Saving Options". | 23 |
| | Setpoint Range Setting | The setpoint temperature range can be restricted for the Cooling, Heating and Auto Mode. | 24 |
| | Setback Condition | Set the setback differential temperature after which the unit will turn back OFF. | 25 |
| | Setpoint Auto Reset | Change the temperature setpoint to a preset temperature setpoint after running for a set period of time, even if the temperature setpoint has been changed. <ul style="list-style-type: none"> • Possible to set from 30 to 120 minutes in 30 minute increments. | 26 |
| | Off Timer | The system is turned off automatically after the selected time each time the system is activated. <ul style="list-style-type: none"> • Possible to set in 10 minute increments from 30 to 180 minutes. | 27 |
| Schedule⁽²⁾ | Enable/Disable | Enable or disable schedule function. | 28 |
| | Select Schedule | Select the active schedule number (schedule nr 1, 2 or 3). | 29 |
| | Holidays | Select the days of the week for which the schedule will be disabled. This function is used for when the schedule doesn't need to be active, e.g. like when you are on holiday. | 30 |
| | Schedule Settings | Select when the operation modes start and/or stop for each day of the week. Up to 5 actions can be set for each day. | 31 |

1) Setback, Setpoint Range, Setback Condition and Setpoint Auto Reset should not be used when a centralised controller is connected via the KRP928 Interface adapter for Room Air Conditioner.

2) The schedule can be restricted when a centralised controller is connected via the KRP928 Interface adapter for Room Air Conditioner.

Quick Reference of Main Menu Items

| Setting and display items | | Description | Reference page |
|--------------------------------|-----------------------------|---|----------------|
| Maintenance Information | | Display the service contact. | 33 |
| Configuration | Display | <ul style="list-style-type: none"> • Display: Switch between Standard or Detailed display. • Detailed display settings: Select if room temperature (near the indoor unit), outdoor temperature, or nothing is displayed. | 34 |
| | Celsius / Fahrenheit | Choose the temperature values from Celsius or Fahrenheit. | 36 |
| | Contrast Adjustment | Adjust the LCD contrast. | 36 |
| Current Settings | | Display a list of the current settings of the available items. | 37 |
| Clock & Calendar | Date & Time | Configure the date and time settings. <ul style="list-style-type: none"> • The default time display is 12H. • The clock will maintain accurate within ± 30 seconds per month. • If there is a power failure for a period not exceeding 48 hours, the clock will continue working with the built-in backup power supply. | 38 |
| | 12H/24H Clock | The time can be displayed in either a 12 hour or 24 hour time format. | 39 |
| | Daylight Saving Time | Enable or Disable the Daylight Saving Time. | 39 |
| Language | | Choose the language from English, French or Spanish. | 40 |

Menu Manipulation

Main Menu

Manipulating the Main Menu

Operation Method

1

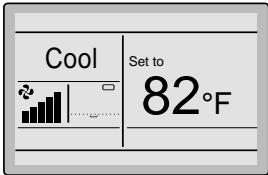

Basic Screen

- Press the Menu/Enter button.

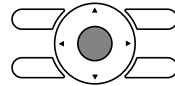

2

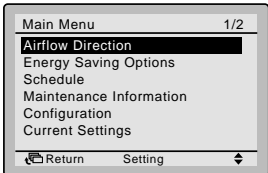

Main Menu

- The Main Menu will appear.

← Instructions for operating the buttons will appear.

3

- Selecting items from the Main Menu.
 1. Press the ▼▲ (Up/Down) buttons to select the desired item.
 2. Press the Menu/Enter button to display the selected settings screen.

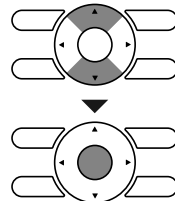

4

- To go back to the Basic Screen from the Main Menu, press the Cancel button.



Caution

- When the Main Menu is visible and a button is not pressed for 5 minutes, the screen will automatically go back to the Basic Screen.

Airflow Direction

Change the Airflow direction

Operation Method

1

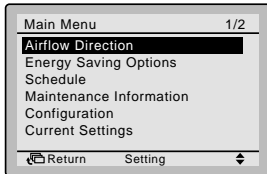

- Display the Main Menu (See "Manipulating the Main Menu" on page 21)
- Press the ▲▼ (Up/Down) buttons to select **Airflow Direction** and press the Menu/Enter button.

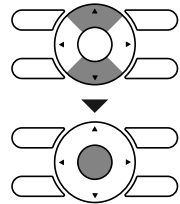

2

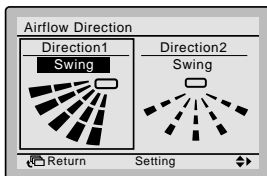

- Select the desired airflow direction from **Swing** or **Swing stop** using the ▲▼ (Up/Down) buttons.
- Select Up/down direction or Left/right direction using the ◀▶ (Left/Right) buttons.
- Press the Menu/Enter button to confirm the settings and to return to the Basic Screen.

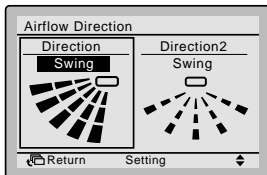
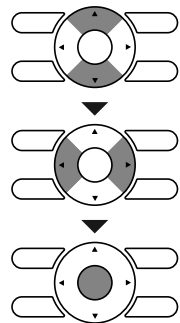

Airflow direction setting (up/down)

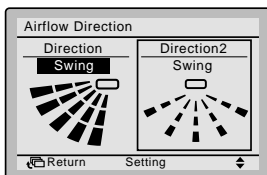

Airflow direction setting (left/right)

Remark: Only visible if available.

Note

- The airflow directions appear on the screen as follows:



Up/down direction



Left/right direction

- Selecting **Swing** will cause the airflow direction blades to swing back and forth. When **Swing** is selected, all airflow directions will be visible at the same time.
- When you select **Swing stop**, the airflow direction blades stay in the position that you press the Menu/Enter button.

Menu Manipulation

Energy Saving Options

■ Energy Saving List

Some functions should not be enabled when a centralised controller is connected via the KRP928 Interface adapter for Room Air Conditioner.

Operation Method

1

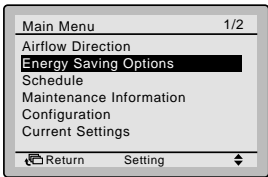

- Display the Main Menu. (See "Manipulating the Main Menu" on page 21).
- Press the ▼▲ (Up/Down) buttons to select **Energy Saving Options** and press the Menu/Enter button.

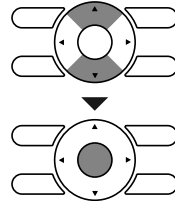

2

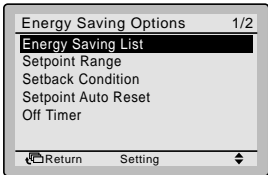

- Press the ▼▲ (Up/Down) buttons to select **Energy Saving List** and press the Menu/Enter button.

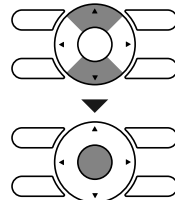

3

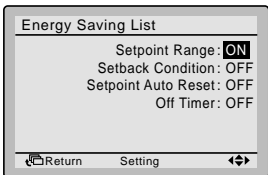

- Press the ▼▲ (Up/Down) buttons to change the setting to **ON** or **OFF**.
- Move the cursor using the ◀▶ (Left/Right) buttons.
- Press the Menu/Enter button when all changes are made. The confirmation screen will appear.

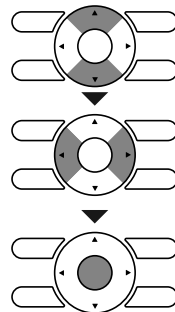

4

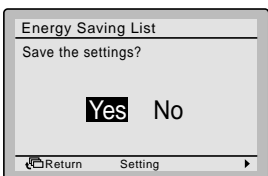

- Press the ◀▶ (Left/Right) buttons to select **Yes**.
- Press the Menu/Enter button to confirm the settings and to return to the Basic Screen.

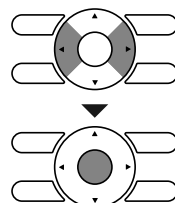

■ Setpoint Range Setting

Operation Method

This function should not be used when a centralised controller is connected via the KRP928 Interface adapter for Room Air Conditioner.

1

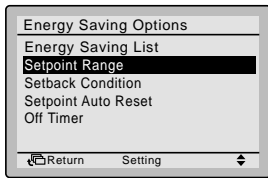

- Display the Energy Saving Options (See "Energy Saving List" on page 23).
- Press the ▼▲ (Up/Down) buttons to select **Setpoint Range** and press the Menu/Enter button.

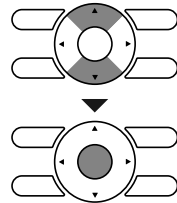

2

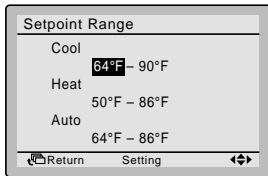

- Press the ▼▲ (Up/Down) buttons to change the cooling or heating temperature setpoint range.
- Move the cursor using the ◀▶ (Left/Right) buttons.
- Press the Menu/Enter button when all changes are made. The confirmation screen will appear.

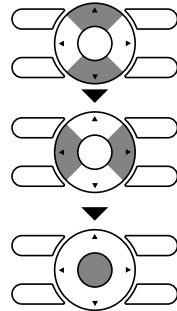

Note

- The default setpoint range restriction is [64°F→90°F] for cooling, [50°F→86°F] for heating, and [64°F→86°F] for auto. This setpoint range is the general setpoint range and is as a result always active regardless of whether Setpoint Range is enabled or disabled.
- The default setpoint range for setback operation is [92°F→99°F] for cooling and [50°F→59°F] for heating. This setpoint range cannot be changed.

3

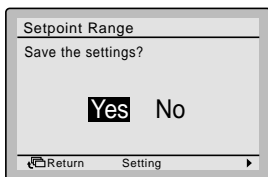

- Press the ◀▶ (Left/Right) buttons to select **Yes**.
- Press the Menu/Enter button to confirm the settings and to return to the Basic Screen.

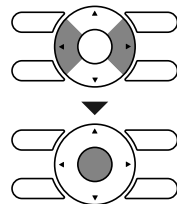

Menu Manipulation

■ Setback Condition

This function should not be used when a centralised controller is connected via the KRP928 Interface adapter for Room Air Conditioner.

Operation Method

1

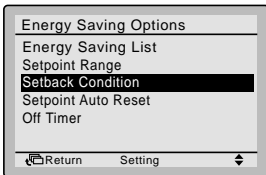

- Display the Energy Saving Options (See "Energy Saving List" on page 23).
- Press the ▼▲ (Up/Down) buttons to select **Setback Condition** and press the Menu/Enter button.

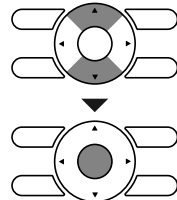

2

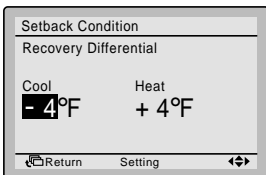

- Press the ▼▲ (Up/Down) buttons to change the differential for setback operation.
- Move the cursor using the ◀▶ (Left/Right) buttons.
- Press the Menu/Enter button when all changes are made. The confirmation screen will appear.

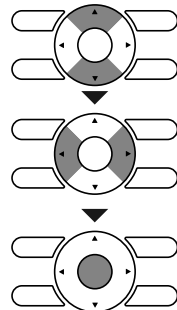

3

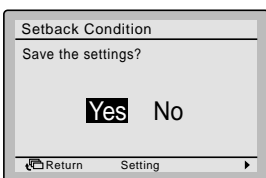

- Press the ◀▶ (Left/Right) buttons to select **Yes**.
- Press the Menu/Enter button to confirm the settings and to return to the Basic Screen.

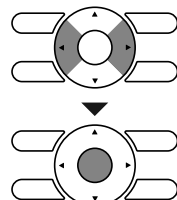

■ Setpoint Auto Reset

This function should not be used when a centralised controller is connected via the KRP928 Interface adapter for Room Air Conditioner.

Operation Method

1

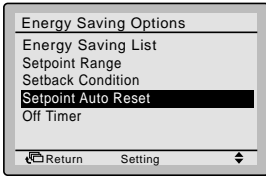

- Display the Energy Saving Options (See "Energy Saving List" on page 23).
- Press the ▼▲ (Up/Down) buttons to select **Setpoint Auto Reset** and press the Menu/Enter button.

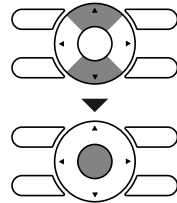

2

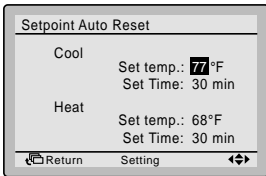

- Press the ▼▲ (Up/Down) buttons to set the preset temperature and timing for the auto reset of the setpoint.
- Move the cursor using the ◀▶ (Left/Right) buttons.
- Press the Menu/Enter button when all the changes are made. The confirmation screen will appear.

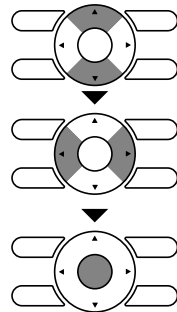

3

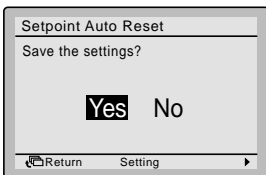

- Press the ◀▶ (Left/Right) buttons to select **Yes**.
- Press the Menu/Enter button to confirm the settings and to return to the Basic Screen.

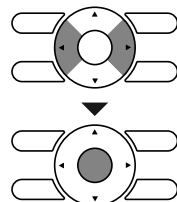

Menu Manipulation

OFF Timer

Operation Method

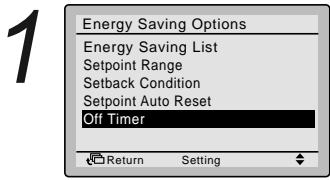

- Display the Energy Saving Options (See "Energy Saving List" on page 23).
- Press the ▼▲ (Up/Down) buttons to select **Off Timer** and press the Menu/Enter button.

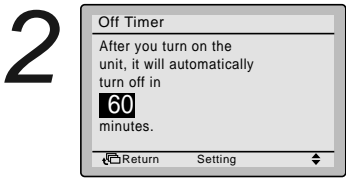
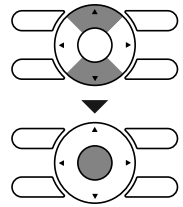

- Use the ▼▲ (Up/Down) buttons to set the time after which the unit automatically turns off again. Selections can be made in increments of 10 minutes from 30 to 180 minutes. Holding down the button causes the number to change continuously. The settings confirmation screen will appear when the Menu/Enter button is pressed.

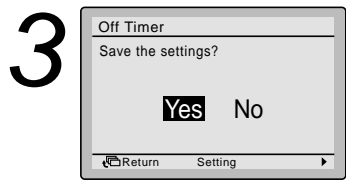
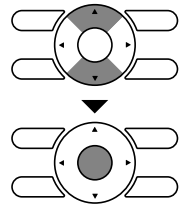

- Press the ◀▶ (Left/Right) button to select **Yes**.
- Press the Menu/Enter button to confirm the settings and to return to the Basic Screen.

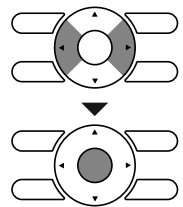

Schedule

■ Enable/Disable

Operation Method

The schedule can be restricted when a centralised controller is connected via the KRP928 Interface adapter for Room Air Conditioner.

1

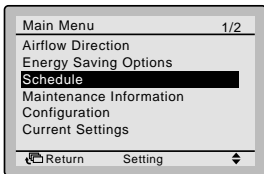

- Display the Main Menu. (See "Manipulating the Main Menu" on page 21).
- Press the ▼▲ (Up/Down) buttons to select **Schedule** and press the Menu/Enter button.

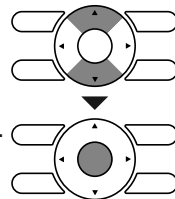

2

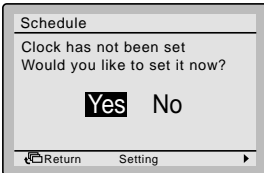

Note

- Before setting the schedule, the clock must be set.
- If the clock has not been set, a screen like the one on the left will appear.

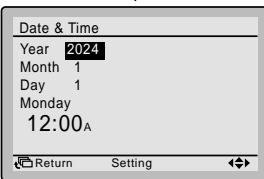

- Press the ◀▶ (Left/Right) buttons to select **Yes** and press the Menu/Enter button.
- The Date & Time screen will appear.
- Set the current year, month, day and time. (See "Clock & Calendar" on page 38).

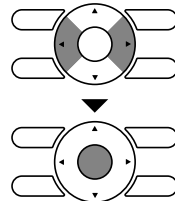

3

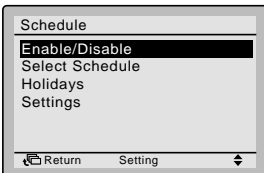

- Press the ▼▲ (Up/Down) buttons to select **Enable/Disable** and press the Menu/Enter button.

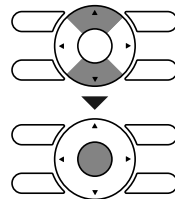

4

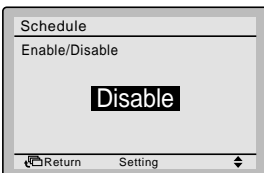

- Press the ▼▲ (Up/Down) buttons to select **Enable** or **Disable**.
- The confirmation screen will appear when the Menu/Enter button is pressed.

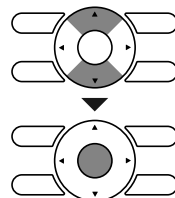

Note

The Schedule is enabled. To modify the Selected schedule number see "Select Schedule" on page 29.

Menu Manipulation

5

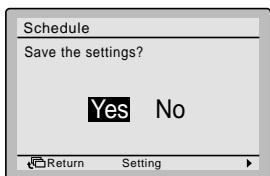

- Press the ◀▶ (Left/Right) buttons to select **Yes**.
- Press the Menu/Enter button to confirm the settings and to return to the Basic Screen.

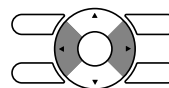

■ Select Schedule

Operation Method

It is possible to program up to three different schedules.

1

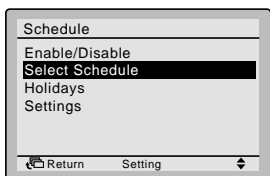

- Display the Schedule menu. (See "Enable/Disable" on page 28).
- Press the ▼▲ (Up/Down) buttons to select **Select Schedule** and press the Menu/Enter button.

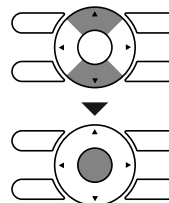

2

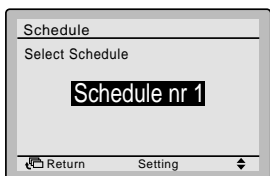

- Press the ▼▲ (Up/Down) buttons to select **Schedule nr 1**, **Schedule nr 2** or **Schedule nr 3**.
- The confirmation screen will appear when the Menu/Enter button is pressed.

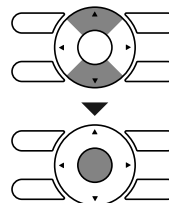

3

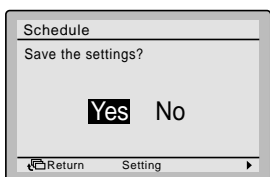

- Press the ◀▶ (Left/Right) buttons to select **Yes**.
- Press the Menu/Enter button to confirm the settings and to return to the Basic Screen.

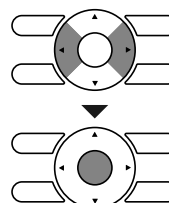

■Holidays

Operation Method The schedule timer will be disabled for days that have been set as a holiday.

1

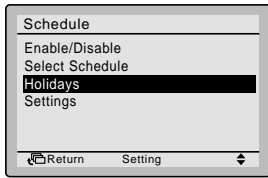

- Display the Schedule menu. (See "Enable/Disable" on page 28).
- Press the ▼▲ (Up/Down) buttons to select **Holidays** and press the Menu/Enter button.

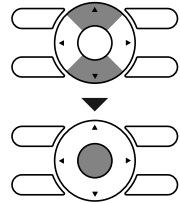

2

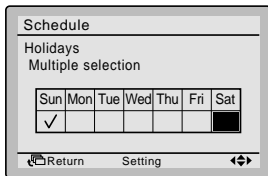

- Press the ◀▶ (Left/Right) buttons to select the desired day.
- Press the ▼▲ (Up/Down) buttons to display "✓" to set this day as a holiday.

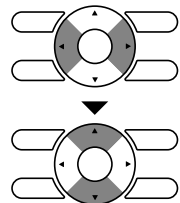

Note

- Multiple days can be selected as holidays.
- To re-enable the schedule timer for the day selected as a holiday, the holiday setting must be released.

3

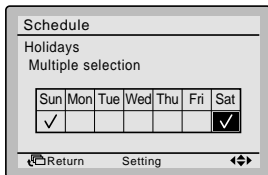

- Press the Menu/Enter button when all changes are made. The settings confirmation screen will appear.

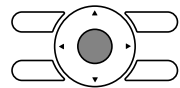

4

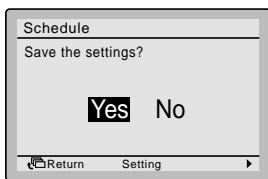

- Press the ◀▶ (Left/Right) button to select **Yes**.
- Press the Menu/Enter button to confirm the settings and to return to the Basic Screen.

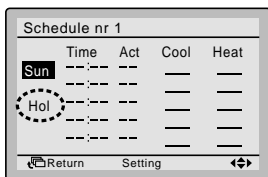
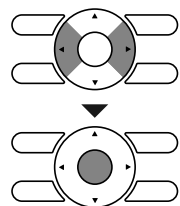

Note

"Hol" will be displayed on the schedule settings screen for days that have been set as a holiday.

Menu Manipulation

■ Schedule Settings

Operation Method After saving a schedule, the schedule is automatically enabled.

1

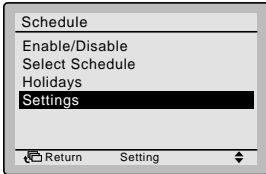

- Display the Schedule menu. (See "Enable/Disable" on page 28).
- Press the ▼▲ (Up/Down) buttons to select **Settings** and press the Menu/Enter button.

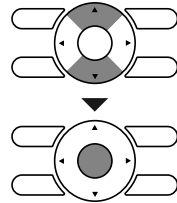

Note

The Schedule Settings of the selected schedule can be modified. To modify the selected schedule see "Select Schedule" on page 29.

2

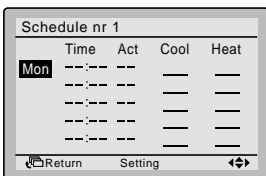

- Press the ▼▲ (Up/Down) buttons to select the day to be set.

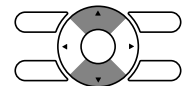

3

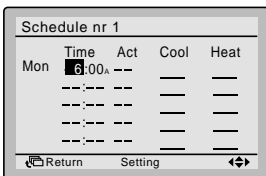

- Set the time for the selected day.
- Press the ◀▶ (Left/Right) buttons to move the highlighted item and press the ▼▲ (Up/Down) buttons to input the desired operation start time. Each press of the ▼▲ (Up/Down) buttons moves the numbers by 1 hour or 1 minute.

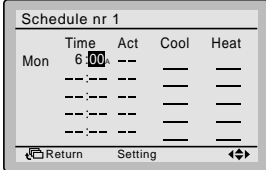
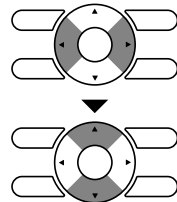

Menu Manipulation

4

| Schedule nr 1 | | | | |
|---------------|------|-----|------|------|
| | Time | Act | Cool | Heat |
| Mon | 6:00 | --- | --- | --- |
| | --- | --- | --- | --- |
| | --- | --- | --- | --- |
| | --- | --- | --- | --- |

| Schedule nr 1 | | | | |
|---------------|------|-----|------|------|
| | Time | Act | Cool | Heat |
| Mon | 6:00 | ON | 74°F | 69°F |
| | --- | --- | --- | --- |
| | --- | --- | --- | --- |
| | --- | --- | --- | --- |

| Schedule nr 1 | | | | |
|---------------|------|-----|------|------|
| | Time | Act | Cool | Heat |
| Mon | 6:00 | ON | 74°F | 69°F |
| | 8:00 | OFF | 95°F | 52°F |
| | --- | --- | --- | --- |
| | --- | --- | --- | --- |

- Press the ◀▶ (Left/Right) buttons to move the highlighted item and press the ▼▲ (Up/Down) buttons to configure ON/OFF/-- settings.

"Act"-column:

- ON : The temperature setpoints can be configured.
- OFF : The setback temperature setpoints can be configured.
- : The temperature and setback temperature setpoints will be disabled.

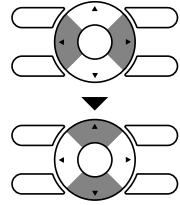

- Press the ◀▶ (Left/Right) buttons to move the highlighted item and press the ▼▲ (Up/Down) buttons to input the cooling and heating temperature setpoints for ON or OFF (Setback) operation.

"Cool" and "Heat" column:

- "_": Indicates that the temperature and setback temperature setpoint for this time period is not specified. The last active setpoint will be utilized.
- "--": Indicates that the setback function is disabled for this time period.

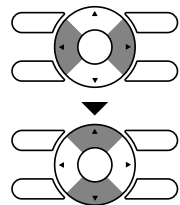

5

| Schedule nr 1 | | | | |
|---------------|-------|-----|------|------|
| | Time | Act | Cool | Heat |
| Mon | 6:00 | ON | 74°F | 69°F |
| | 8:00 | OFF | 95°F | 52°F |
| | 5:30 | ON | 74°F | 69°F |
| | 10:00 | --- | --- | --- |
| | --- | --- | --- | --- |

| Schedule nr 1 | | | | |
|---------------|-------|-----|------|------|
| | Time | Act | Cool | Heat |
| Mon | 6:00 | ON | 74°F | 69°F |
| | 8:00 | OFF | 95°F | 52°F |
| | 5:30 | ON | 74°F | 69°F |
| | 10:00 | OFF | 95°F | 52°F |
| | --- | --- | --- | --- |

| Schedule nr 1 | | | | |
|---------------|-------|-----|------|------|
| | Time | Act | Cool | Heat |
| Tue | 6:00 | ON | 74°F | 69°F |
| | 8:00 | OFF | 95°F | 52°F |
| | 5:30 | ON | 74°F | 69°F |
| | 10:00 | OFF | 95°F | 52°F |
| | --- | --- | --- | --- |

Note

A maximum of 5 actions per day can be set.

- Press the Menu/Enter button when all changes are made. The confirmation screen will appear.

Note

To copy the settings from the previous day, press the Operation Mode Selector button. Example: To copy the contents of Monday to Tuesday, select Tuesday and press the Operation Mode Selector button.

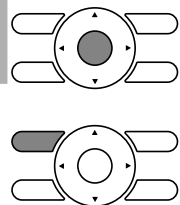

Menu Manipulation

6

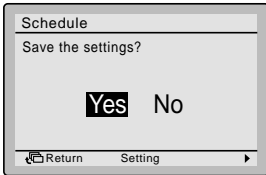

- Press the ◀▶ (Left/Right) buttons to select **Yes**.
- Press the Menu/Enter button to confirm the settings and to return to the Basic Screen.

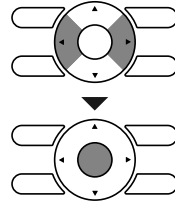

Maintenance Information

■ Display the Maintenance Information

Operation Method

1

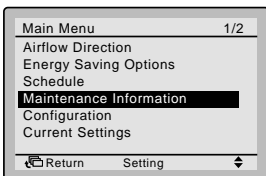

- Display the Main Menu. (See "Manipulating the Main Menu" on page 21).
- Press the ▼▲ (Up/Down) buttons to select **Maintenance Information** and press the Menu/Enter button.

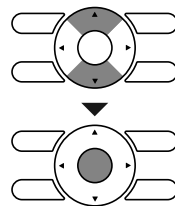

2

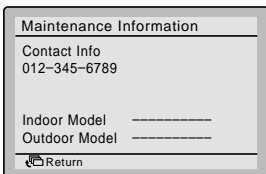

- The phone number for the contact address will appear at the top of the screen. (If you have not yet registered your product, it will not appear).
- The model information of the indoor and outdoor units of your product will always show -----.
- Press the Cancel button to return to the previous screen.



Note

- The error code may also appear. If the operation lamp is not blinking, the unit is working properly.
- The error code record will disappear if you press the ON/OFF button for more than 4 seconds.



Configuration

■ Display

Display Mode

Operation Method

1

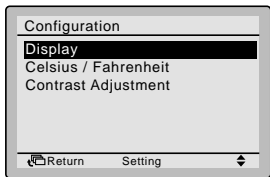

- Display the Configuration menu.
- Press the ▼▲ (Up/Down) buttons to select **Display** and press the Menu/Enter button.

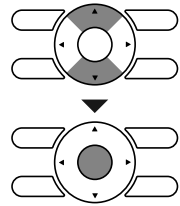

2

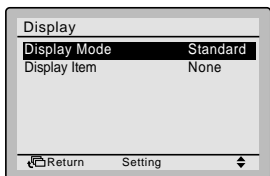

- Press the ▼▲ (Up/Down) buttons to select **Display Mode** and press the Menu/Enter button.

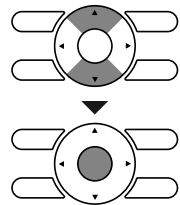

3



- Press the ▼▲ (Up/Down) buttons to select **Standard** or **Detailed**.
- Press the Menu/Enter button to confirm the settings and to return to the Basic Screen.

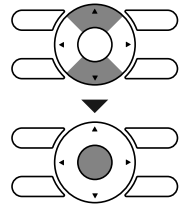

Note

To select which item is displayed in the detailed display selection area, refer to "Detailed Item" on page 35.

Menu Manipulation

Detailed Item

Operation Method

1

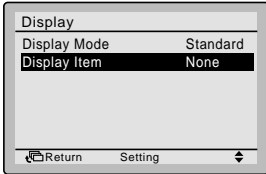

- Display the Display menu. (See "Display Mode" on page 34).
- Press the ▼▲ (Up/Down) buttons to select **Display Item** and press the Menu/Enter button.

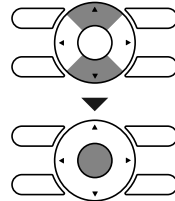

2

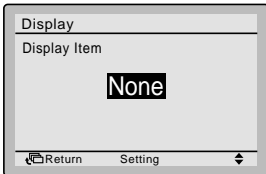

- Press the ▼▲ (Up/Down) buttons to display the following.

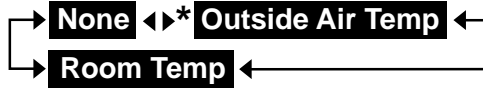
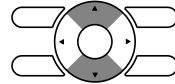

* Some models may not display these items even if they are selected.

- Be sure to read the following regarding the display of the room and outdoor temperature.

Room Temp

- The temperature near the indoor unit.
- The temperature that is detected may be affected by the location of the unit.

Outside Air Temp

- The temperature detected near the outdoor unit.
- The temperature that is detected may be affected by factors such as the location of the unit (e.g. if it is in direct sunlight) and unit operation during defrosting.
- "Outside Air Temp" will not display after stopping or immediately after starting.

- Press the Menu/Enter button to confirm the settings and to return to the Basic Screen.

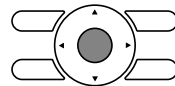

■ Celsius / Fahrenheit

Operation Method

1

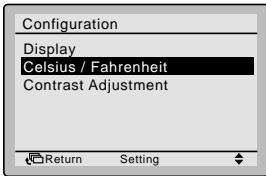

- Display the Configuration menu.
- Press the ▼▲ (Up/Down) buttons to select **Celsius / Fahrenheit** and press the Menu/Enter button.

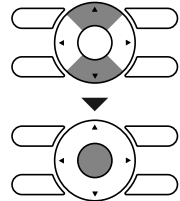

2

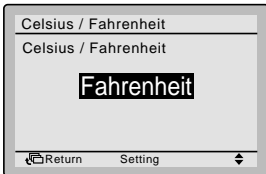

- Press the ▼▲ (Up/Down) buttons to select **Fahrenheit** or **Celsius**.
- Press the Menu/Enter button to confirm the settings and to return to the Basic Screen.

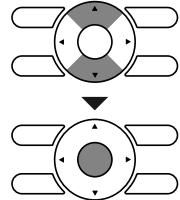

■ Contrast Adjustment

Operation Method

1

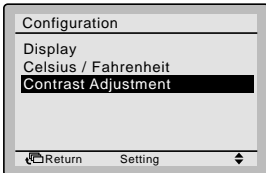

- Display the Configuration menu.
- Press the ▼▲ (Up/Down) buttons to select **Contrast adjustment** and press the Menu/Enter button.

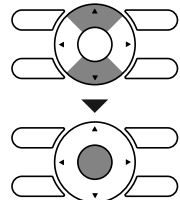

2

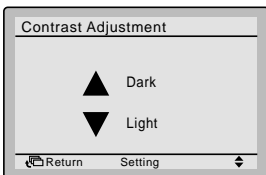

- Press the ▼▲ (Up/Down) buttons until you reach the desired contrast.
- Press the Menu/Enter button to confirm the setting and to return to the Basic Screen.

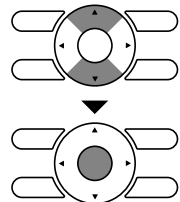

Menu Manipulation

Current Settings

Overview of the Current Settings

Operation Method

1

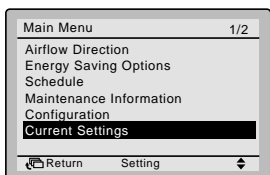

- Display the Main Menu. (See "Manipulating the Main Menu" on page 21).
- Press the ▼▲ (Up/Down) buttons to select **Current Settings** and press the Menu/Enter button.

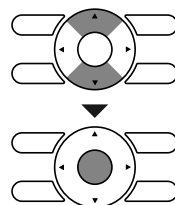

2

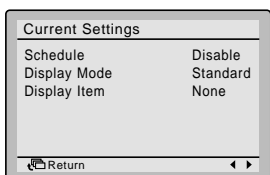

- A list showing the status of the current settings will appear.
- Press the Cancel button to return to the Main Menu.



| Display items | | |
|---------------|--------------|--------------|
| Schedule | Display Mode | Display Item |

* Display items may differ depending on the model. Only the items that can be set are displayed.

Clock & Calendar

■ Date & Time

Operation Method

1

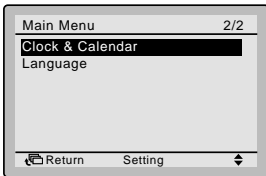

- Display the Main Menu. (See "Manipulating the Main Menu" on page 21).
- Press the ▼▲ (Up/Down) buttons to select **Clock & Calendar** and press the Menu/Enter button.

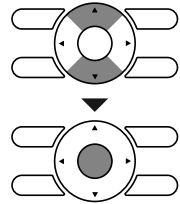

2

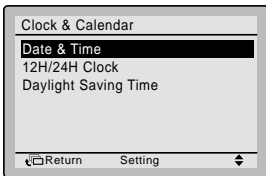

- Press the ▼▲ (Up/Down) buttons to select **Date & Time** and press the Menu/Enter button.

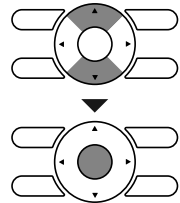

3

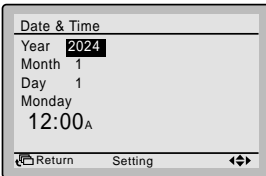

- Use the ▼▲ (Up/Down) buttons to change the date and time.
- Move the cursor using the ◀▶ (Left/Right) buttons.
- Press the Menu/Enter button when all changes are made. The confirmation screen will appear.

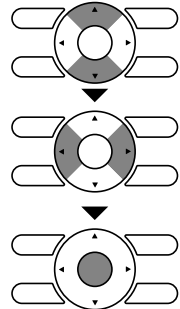

⚠ Caution

- By default, Daylight Saving Time (DST) is active. The following rules apply:
 - Start: Second Sunday of March 2:00 am
 - End: First Sunday of November 2:00 am
- Please consult your Daikin dealer if the DST settings need to be changed.

Note

The day of the week is set automatically.

4

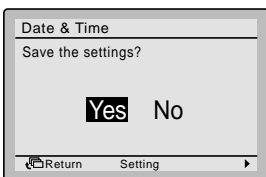

- Press the ◀▶ (Left/Right) button to select **Yes**.
- Press the Menu/Enter button to confirm the settings and to return to the Basic Screen.

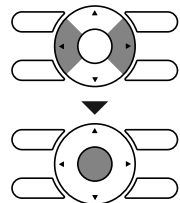

Menu Manipulation

■ 12H/24H CLOCK

Operation Method

1

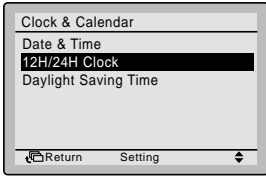

- Display the Clock & Calendar menu. (See "Date & Time" on page 38).
- Press the ▼▲ (Up/Down) buttons to select **12H/24H Clock** and press the Menu/Enter button.

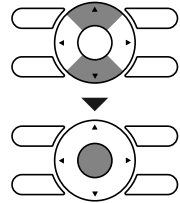

2

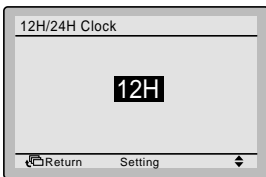

- Press the ▼▲ (Up/Down) buttons to select **12H** or **24H**.
- The confirmation screen will appear when the Menu/Enter button is pressed.

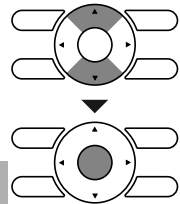

Note

By default, the time display is set to the 12H format.

3

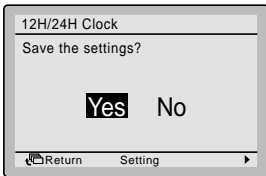

- Press the ◀▶ (Left/Right) buttons to select **Yes**.
- Press the Menu/Enter button to confirm the setting and to return to the Main Menu.

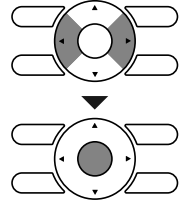

■ Daylight Saving Time

Operation Method

1

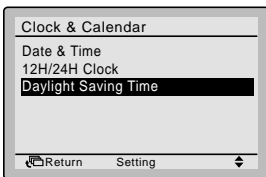

- Display the Clock & Calendar menu. (See "Date & Time" on page 38).
- Press the ▼▲ (Up/Down) buttons to select **Daylight Saving Time** and press the Menu/Enter button.

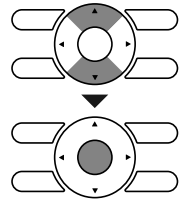

2



- Press ▼▲ (Up/Down) buttons to select **Enable** or **Disable**.
- Press Menu/Enter button to display the setting confirmation screen.

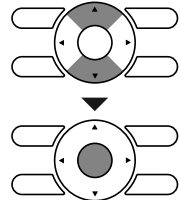

3

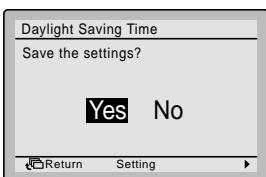

- Press the ◀▶ (Left/Right) buttons to select **Yes**.
- Press the Menu/Enter button to confirm the setting and to return to the Main Menu.

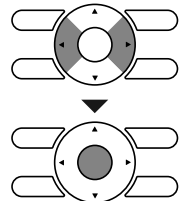

Language

■ Select the Language

Operation Method

1

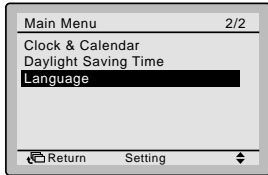

- Display the Main Menu. (See "Manipulating the Main Menu" on page 21).
- Press the ▼▲ (Up/Down) buttons to select **Language** and press the Menu/Enter button.

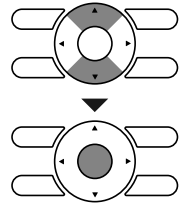

2

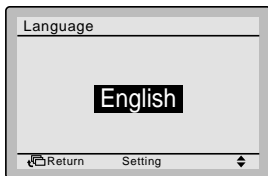

- Press the ▼▲ (Up/Down) buttons to select the preferred language (English, French or Spanish).
- Press the Menu/Enter button to confirm the settings and to return to the Basic Screen.

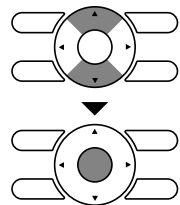

Maintenance

Caution

- **Do not wash the remote controller.**
Doing so may cause electric leakage and result in electric shocks or fire.



- **Be sure to stop the operation of the air conditioner and turn off the power supply breaker when performing maintenance activities.**



Failure to do so may result in electric shocks or injury.

Maintenance of Unit and the LCD display

Note:

- Wipe the LCD display and the rest of the surface of the remote controller with a dry cloth when they become dirty.
- If the dirt on the surface cannot be removed, soak the cloth in neutral detergent diluted with water, squeeze the cloth tightly, and clean the surface. Wipe the surface with a dry cloth afterwards.
- Do not use any paint thinner, organic solvent or strong acid.

Warning

Do not use flammable materials (e.g., hair spray or insecticide) near the air conditioner.

Do not clean the product with organic solvents such as benzine or paint thinner.

The use of organic solvents may cause crack damage to the product, electric shocks or fire.



Reference Information

Error Code Display

Contact your Daikin dealer in the following cases

Warning

When the air conditioner is malfunctioning (e.g., giving off a burning odor), stop the air conditioner and turn off the power.

Continued operation under such circumstances may result in failure, electric shocks or fire. Contact your Daikin dealer.



Operation Method

1

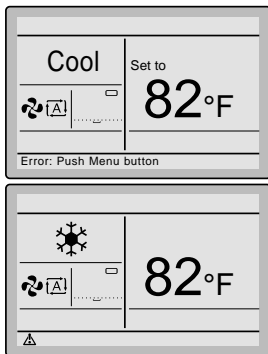

- If an error occurs, the error message or error icon and the operation lamp will blink.
- To display the error code and contact information, the Menu/Enter button needs to be enabled (See "Manipulating the Main Menu" on page 21).
- Press the Menu/Enter button.

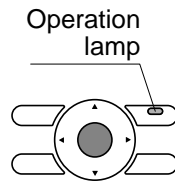

2

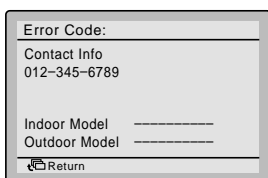

- The error code blinks and the contact address will appear.
- Notify your Daikin dealer of the Error code and Model name.

Reference Information

"Mode Conflict" message

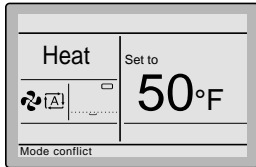

Only applicable in the case of multi systems (multiple indoor units connected to the outdoor unit) and for connected indoor units that support this functionality. When multiple indoor units are instructed to operate simultaneously, but in different operation modes, an operation mode conflict occurs:

- The operation lamp flashes
- **Mode conflict** appears on the user interface

• The units that do not have priority enter standby mode
 This is not a malfunction. To solve the conflict, make the units that do not have priority run in the same operation mode as that of the unit that has priority. Which unit has priority depends on whether the Priority Room setting is present and/or active:

| If... | Then... |
|---|--|
| The Priority Room setting is present and active. | The operation mode of the indoor unit to which the Priority Room setting is applied takes priority. In case of an operation mode conflict, the other units will enter standby mode. |

! NOTICE

- COOL, DRY and FAN operation can be used simultaneously.
- If the conflict is not solved manually, non-priority units will automatically resume operation as soon as the priority unit stops operating.

| If... | Then... |
|--|--|
| The Priority Room setting is not present OR present but not active. | The operation mode of the indoor unit that was turned on first takes priority. In case of an operation mode conflict, the units that were turned on later will enter standby mode. |

! NOTICE

- COOL, DRY and FAN operation can be used simultaneously.
- Units running in HEAT operation mode always have priority over units running in FAN operation mode, even if they were not turned on first.
- When solving the conflict, it is possible to make the non-priority units run in AUTO operation mode: they will automatically start operation in the same operation mode as that of the priority unit.

Caution

The **MODE CONFLICT** can also happen to units that are turned on by the **setback** function. This means that due to priority, they will not run and consequently will not be able to maintain the temperature in the room. Please consider the use of the **setback** feature in a multi system carefully to avoid situations like these.



Caution

When a KRP928 Interface adapter for Room Air Conditioner is connected, the mode conflict message will not be shown on the user interface, but the indoor unit will go into standby mode.



Combined use of the wired and wireless user interface

Avoid using the wired remote controller and the wireless remote controller at the same time.

- The wireless user interface does not receive feedback from the unit. When a setting is changed on the wired remote controller, the change is not communicated to the wireless remote controller.
- Since some functions of both controllers are not supported by each other, the displays will not match.

FCC Notice

This device complies with Part 15 of the FCC Rules. Operation is subject to the following two conditions:

- (1) This device may not cause harmful interference, and
- (2) This device must accept any interference received, including interference that may cause undesired operation.

CAN ICES-003(B)/NMB-003(B)

The FCC responsible party is Daikin Comfort Technologies Manufacturing, L.P., and may be contacted by calling (713)-861-2500, or at 19001 Kermier Rd., Waller, TX 77484.
(<https://www.northamerica-daikin.com>)

NOTE: This equipment has been tested and found to comply with the limits for a Class B digital device, pursuant to part 15 of the FCC Rules. These limits are designed to provide reasonable protection against harmful interference in a residential installation. This equipment generates, uses and can radiate radio frequency energy and, if not installed and used in accordance with the instructions, may cause harmful interference to radio communications. However, there is no guarantee that interference will not occur in a particular installation. If this equipment does cause harmful interference to radio or television reception, which can be determined by turning the equipment off and on, the user is encouraged to try to correct the interference by one or more of the following measures:

- Reorient or relocate the receiving antenna.
- Increase the separation between the equipment and receiver.
- Connect the equipment into an outlet on a circuit different from that to which the receiver is connected.
- Consult the dealer or an experienced radio/ TV technician for help.

2.3 <BRC944B2> Wired Remote Controller (Installation)

⚠ CAUTION

1. No switch box or staple is supplied. Prepare them locally.
2. No remote controller cord is supplied. Prepare the optional remote controller cord 4 wire.
3. Be sure to turn off the power to any apparatus connected prior to mounting.
4. Prior to mounting equipment, touch something metallic such as a doorknob to remove static electricity from your body. Never touch the remote controller board or the adapter board.
5. Keep the wiring away from any other power source lines to avoid electric noise (external noise).
6. Select a flat surface, wherever possible, to mount the remote controller. To prevent deformation of the cases, do not overtighten the mounting screws.

1. Securing the remote controller lower case

Insert a bladed screwdriver into the concave (凹) in the remote controller lower case to remove the upper case assembly (two locations).

The remote controller board is located on the upper case. Take care not to scratch the board with the screwdriver.

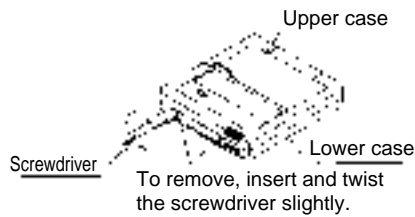

(1) Exposed mounting
Secure the remote controller lower case with the two supplied wood screws.

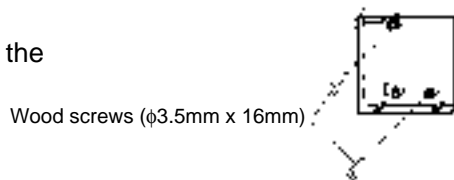

(2) Embedded mounting
Secure the remote controller lower case with the two supplied machine screws.

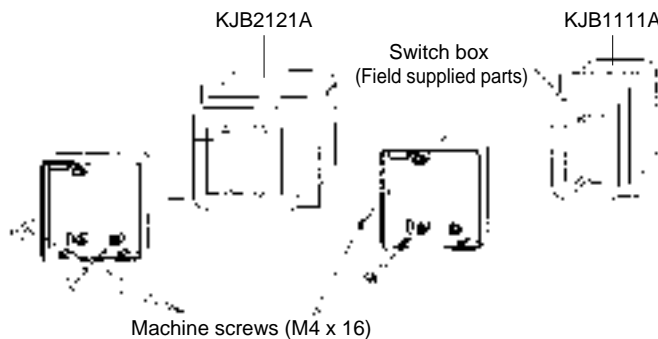

For the field supplied switch box, use optional accessories KJB1111A or KJB2121A.

2. Securing the remote control adapter

Remove the upper case of the remote control adapter and secure the lower case assembly.

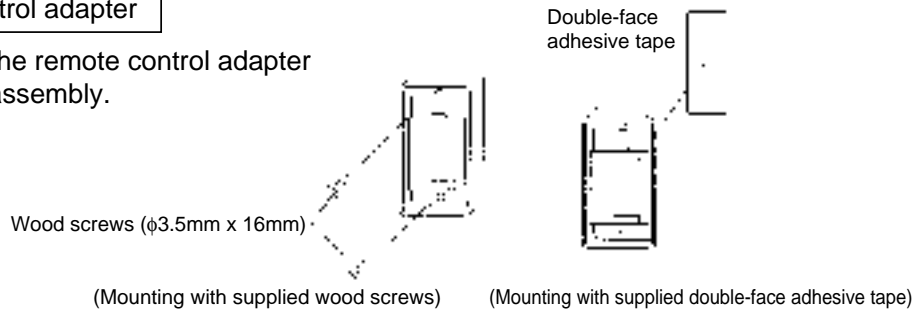

3. Wiring

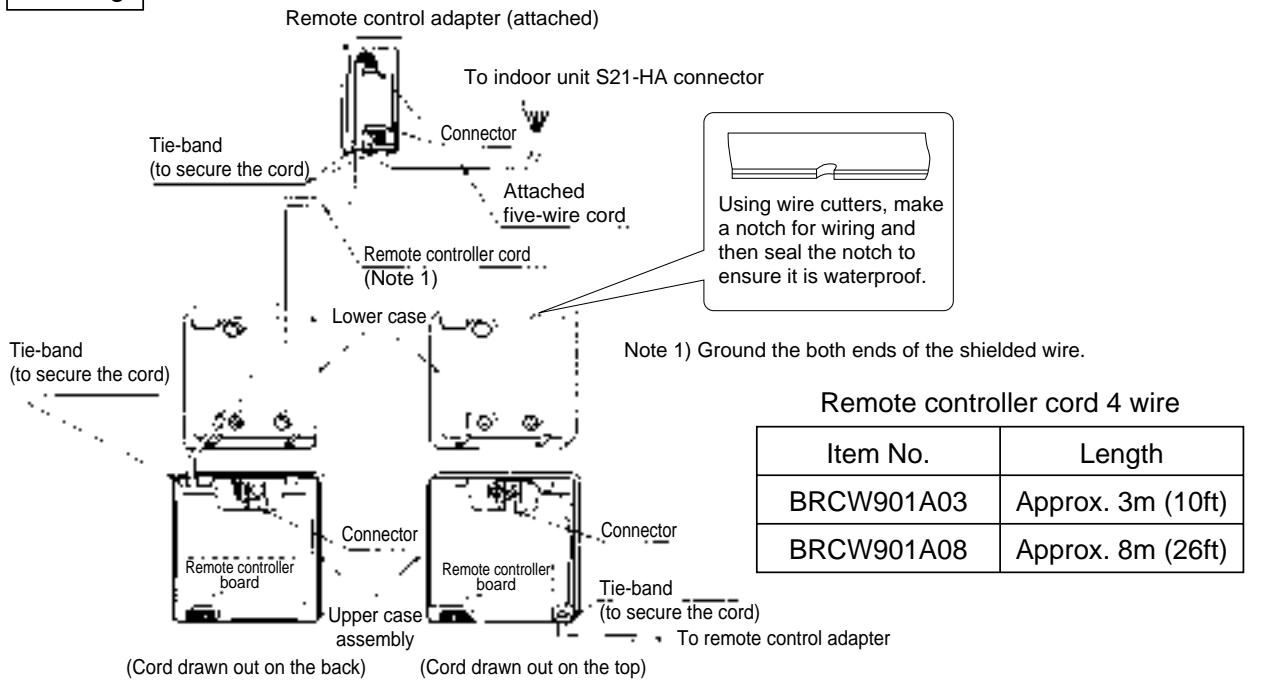

4. Placing the upper case assembly of the remote controller and the upper case of the remote controller adapter back into their original positions

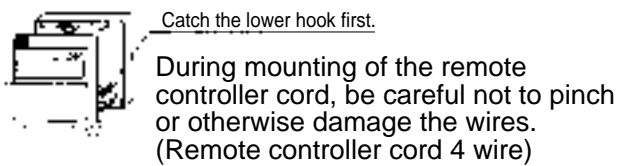

5. Temperature indication change

To change from Celsius temperature indication to Fahrenheit one

Press and hold down at the same time for 5 seconds while the Celsius temperature is indicated.

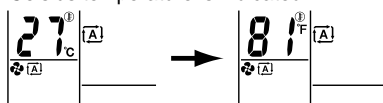

← See Operation Manual

2.4 <BRC944B2> Wired Remote Controller (Operation)

Controller Commands and their Corresponding Functions

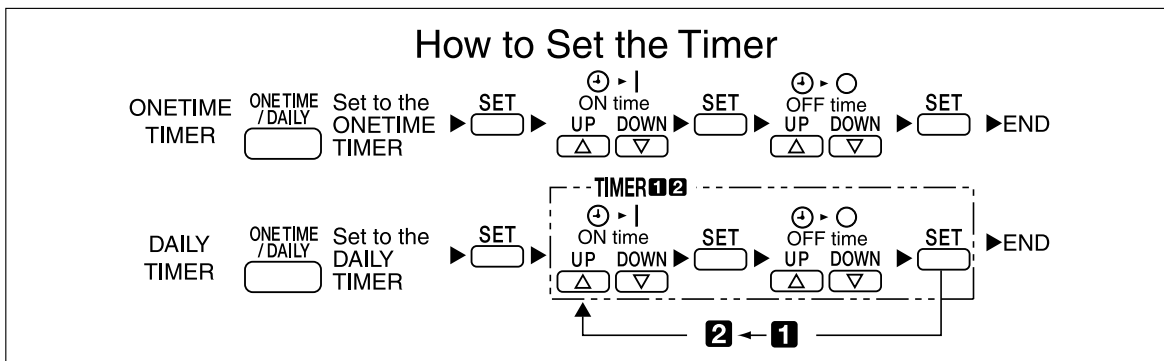
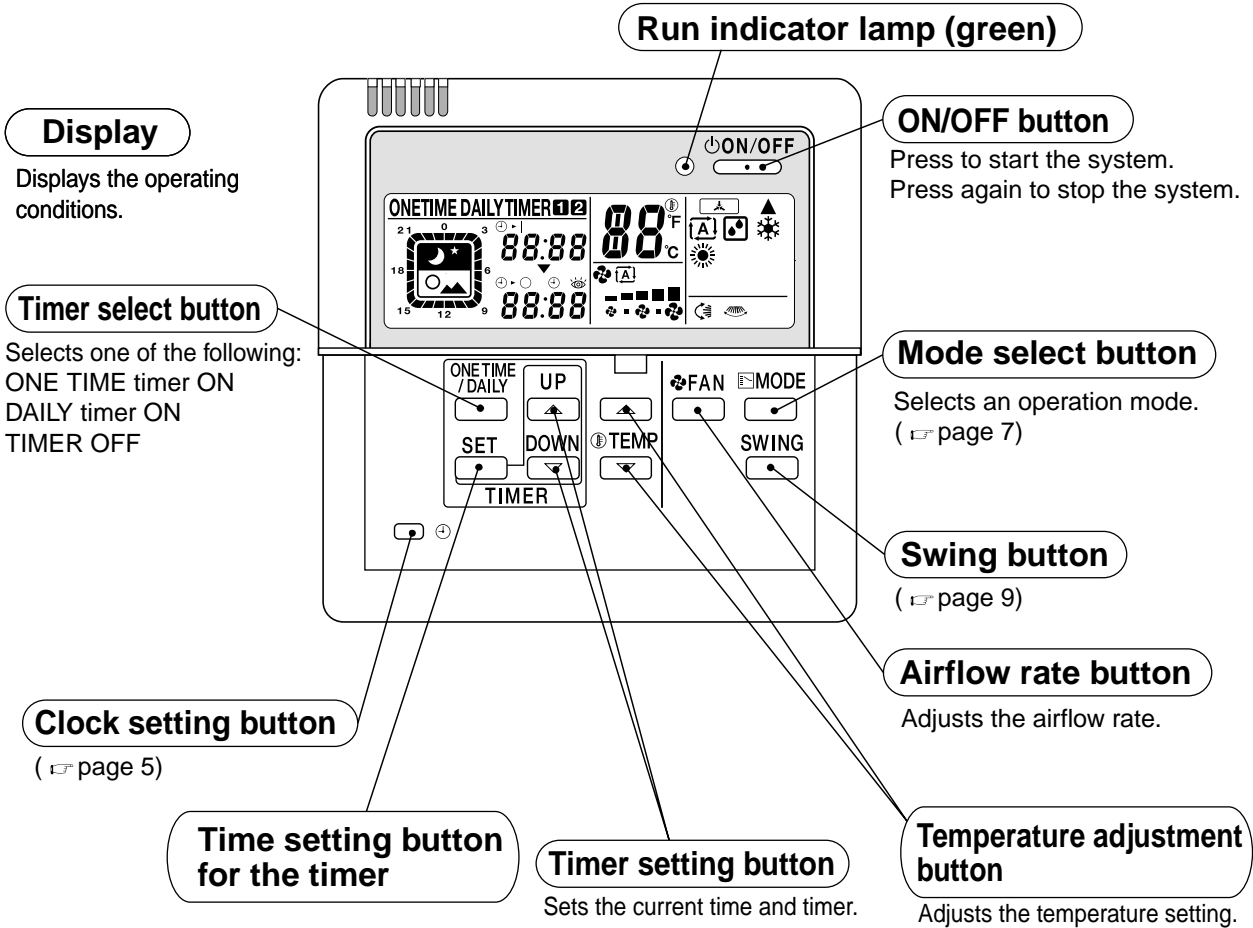

CAUTION

- This remote controller cannot be used together with a standard wireless remote controller. Otherwise, what appears on this remote controller's display may fail to correspond to actual operating conditions.

Preparation before Operation

■ Checking the power

If nothing appears on the remote controller's display, turn on the circuit breaker.

■ Setting the current time

1 Press .



The current time starts blinking.
0:00 lights up.

2 Press and set the current time.

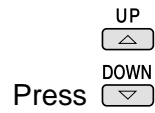

3 Press .

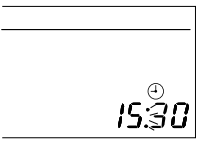

: blinks.
(This completes the current time setting)

- The clock's accuracy is ±30 seconds per month.

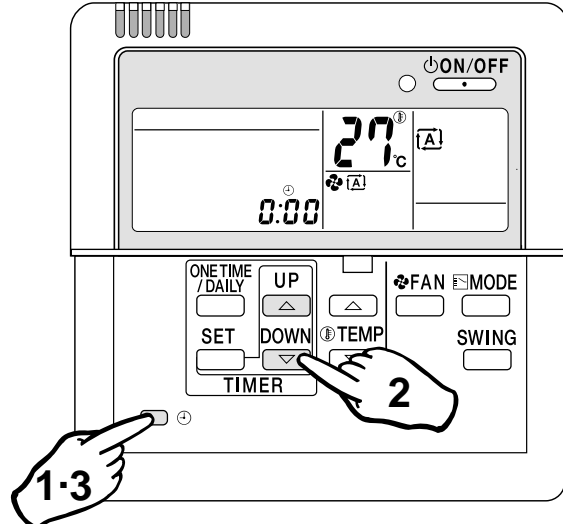

Notes

To use the unit efficiently

- Avoid overcooling or overheating. Moderate room temperature setting contributes to power saving.

Recommended temperature setting

For cooling 26~28°C (79°F~82°F)

For heating 20~22°C (68°F~72°F)
- Hang a blind or a curtain on the window. This will enhance the cooling/heating effect by intercepting direct sunlight and drafts.
- A clogged air filter reduces the cooling/heating effect and wastes energy. Clean the air filter monthly (every two weeks as required) or so.

Please take note of the following points

- Electric power is consumed even when the air conditioner is not in operation.
- When the unit is not used for a long period of time such as during off-season, turn off the breaker.

Operating conditions

- If the operation is continued under any conditions other than the following, the safety device may work to stop the operation. Also, dew may form on the indoor unit and drip from it. (Cooling/DRY)

| | | |
|---------|-----------------|-----------------------------|
| Cooling | Outdoor temp. | -10 to 46°C (14°F to 115°F) |
| | Room temp. | 18 to 32°C (64°F to 90°F) |
| | Indoor humidity | Less than 80% |
| DRY | Outdoor temp. | -10 to 46°C (14°F to 115°F) |
| | Room temp. | 18 to 32°C (64°F to 90°F) |
| | Indoor humidity | Less than 80% |
| Heating | Outdoor temp. | -15 to 20°C (5°F to 68°F) |
| | Room temp. | Less than 27°C |

- Operation limit differ according to the model.

Preparation before Operation

■ Setting Temperature Indication change

Temperature indication can be changed between Celsius and Fahrenheit before use.

To change from Celsius temperature indication to Fahrenheit one

- 1 Press and hold down  at the same time for 5 seconds while the Celsius temperature is indicated.

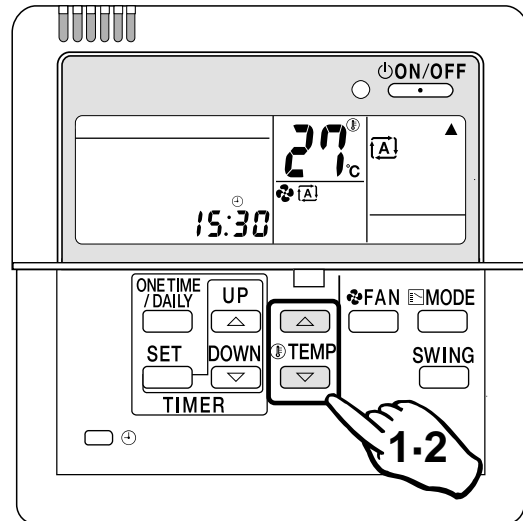
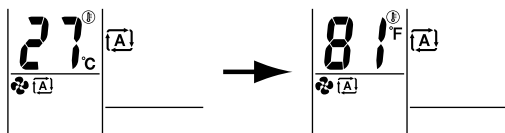

To change from Fahrenheit temperature indication to Celsius one

- 2 Press and hold down  at the same time for 5 seconds while the Fahrenheit temperature is indicated.

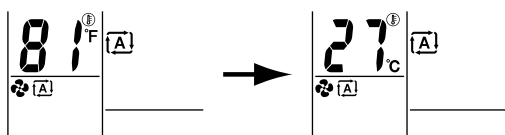

Notes

■ Temperature indication change between Celsius and Fahrenheit on the remote controller

- Change the temperature indication in the modes other than the DRY mode. In the DRY mode, temperature indication setting cannot be changed because the temperature is not indicated.
- When the Fahrenheit temperature indication is changed to Celsius one, the temperature value (0.5°C) will be rounded up. Thus, the preset temperature may be changed.

Example:

A preset temperature of 65°F (equivalent to 18.5°C) will be changed to 19°C (66°F) by changing the temperature indication. In this case, if you change the Celsius temperature indication again to the Fahrenheit one, the preset temperature is shown not as 65°F but as 66°F (equivalent to 19°C). If the preset temperature is 66°F (equivalent to 19°C) and is changed to the Celsius temperature indication, the indication becomes 19°C (66°F). In this case, no change by the temperature indication change is observed.

- When the temperature indication change is set, the preset temperature is transmitted to the indoor unit so that the reception sound will be heard from the indoor unit.

Automatic-DRY-Cooling-Heating Operation

Select your desired operation mode.

Once preset, the system can get restarted in the same operation mode.

1 Press  to select your desired operation mode.

- Each time the button is pressed, the mode changes as follows.

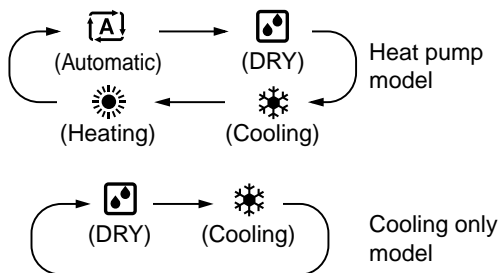

- The system does not have the FAN mode.

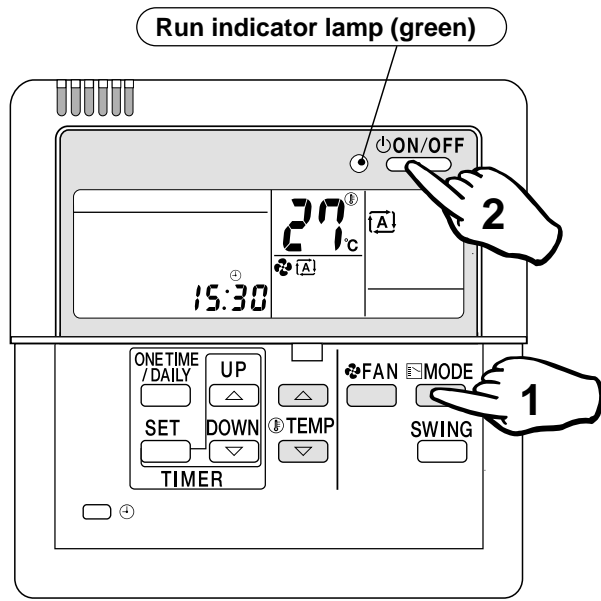

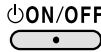
2 Press .

The run indicator lamp lights up.

■ To stop the operation:

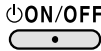
Press  again.

The run indicator lamp goes out.

Automatic operation

- In Automatic, the temperature setting and operation mode (DRY, Cooling or Heating) are automatically selected according to the room temperature and outdoor temperature at the time of starting operation.

DRY operation



- In this mode, humidity is removed from the air.



Note

- While running in the DRY mode, you may feel cool or warm air from the air outlet. In this case, readjust the airflow direction with the vertical airflow direction louvers. (except Duct Connected type)

■ To adjust the temperature and airflow rate:

| Operation mode Setting to be adjusted | Automatic | Cooling | Heating | DRY |
|---|--|---------|---------|----------------------------------|
|  (Temperature) | Temperature is adjustable. Recommended temperature Cooling : 26°C-28°C (79°F~82°F) Heating : 20°C-22°C (68°F~72°F) | | | Temperature cannot be adjusted. |
|  (Airflow rate) | Five levels of airflow rate setting from " " to " " plus " [A] " are available.  | | | Airflow rate cannot be adjusted. |

- When the unit runs in the cooling or heating mode at a low airflow rate, the cooling or heating effect may be insufficient.

■ To adjust the airflow direction:

(page 9)

Heating operation

- Since the heating operation is performed by taking the heat from outdoor into the room, the heating capacity decreases as the outdoor temperature lowers. If the room is not heated sufficiently, it is recommended to use other heating appliance at the same time.
- Since the air conditioner heats the whole room by circulating hot air, it takes some time to heat the entire room completely.
- If the outdoor unit gets frosted during heating operation, the heating capacity is decreased. In this case, the unit starts defrosting operation.
- No hot air comes out of the indoor unit during defrosting operation.

Adjusting Airflow Direction

Adjust the airflow direction for maximum comfort.

To adjust the Airflow Direction

1 Press **SWING** during operation.

- Each time the button is pressed, the airflow direction louvers change their movement.

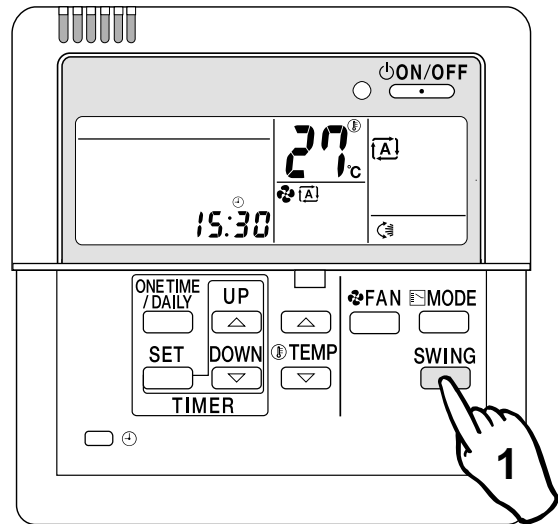

■ Wall Mounted Types (without horizontal swing function)

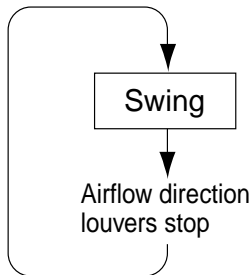

The horizontal airflow direction louvers move up and down.

The louvers stop just when the button is pressed.

Adjustment of horizontal airflow direction

- The automatic moving range of the horizontal airflow direction louvers varies depending on the operation mode.



Notes

- In fixing the horizontal airflow direction, keep the horizontal airflow direction louvers tilted downward in the heating mode, and keep them nearly horizontal level in the cooling or DRY mode. This will enhance the cooling and heating effect.
- On the air conditioners with vertical and horizontal swing function, be sure to adjust the airflow directions using the remote controller. Do not forcibly adjust louvers by hand or a malfunction may occur.

■ Wall Mounted Type (with horizontal swing function)

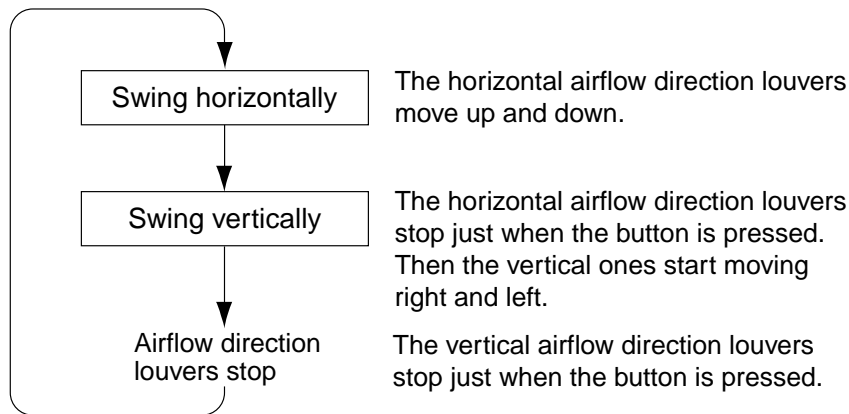

- The vertical and horizontal louvers cannot move at the same time.

■ Duct Connected Type (without swing function)

This function cannot be used.



Note

- The operating procedure and remote controller display are different depending on the indoor unit being connected. Read **How to Adjust the Airflow Direction** in the air conditioner's Operation Manual.

Timer Operation

The Timer Operation feature automatically turns off operation when you go to sleep and turns it back on when you wake up. Use the DAILY Timer mode on weekdays, and the ONE TIME timer mode on weekends.

■ To select the ONE TIME timer mode:

1 Press **ONE TIME / DAILY** to select the ONE TIME timer mode.

- Each time the button is pressed, the modes change as follows.

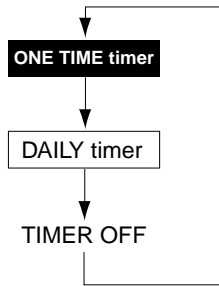

The timer lamp lights up.

■ To cancel the timer settings:

1 Press **ONE TIME / DAILY** to clear the timer settings.

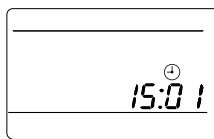

The **ONE TIME** or **DAILY TIMER** disappears from the display, and the timer lamp goes out too.

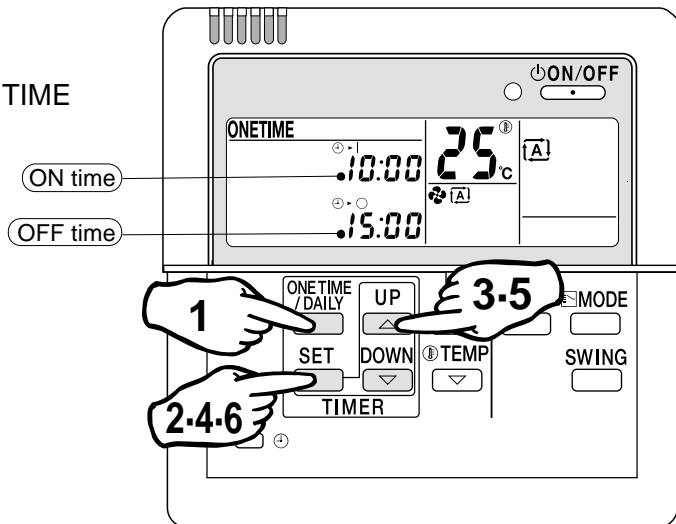

(Timer settings displayed)



Notes

- Even when the timer has been off, its programmed settings are still in memory.
- If the system has the timer control ON but you start and stop it manually using the ON/OFF button before the designated ON time, the system will restart again at the programmed ON time.

Precautions in setting the timer



- Before starting the timer operation, make sure the current time is correct. If not, set the clock correctly. (→ page 5)
- In making time settings, --:-- is displayed to make it easy to disable the timer too.
- If one minute has passed before making any timer setting, the previous timer settings are reintroduced and the timer is on standby. In this case, use the **SET** (time setting) button and make your desired timer settings.

Timer operation

- When the ON timer is programmed, the system starts one hour (maximum) earlier so that the temperature set by the remote controller is reached just in time.
- When the ONE TIME timer is programmed, the current time is no longer displayed.

■ ONE TIME timer

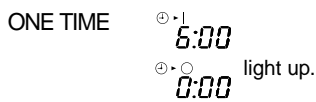

Once the timer has been activated and then deactivated, it is in the OFF mode. The ON or OFF timers can be programmed.

1 Press  to select the ONE TIME timer. **4** Press .



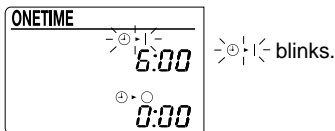

2 Press .

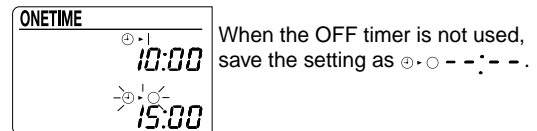

5 Press   to make the OFF timer setting.



3 Press   to make the ON timer setting.

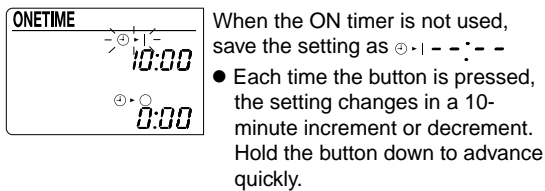

6 Press  .
(The ONE TIME timer is now programmed.)

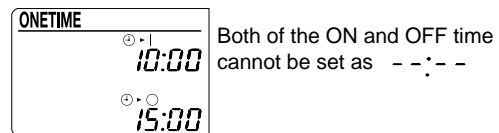

Example of display with the ONE TIME timer programmed

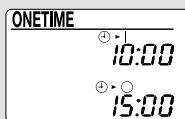

ONE TIME timer programmed.
(The set time is displayed.)



ON timer activated and system starts.
(The ON timer setting no longer displays.)

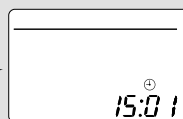

OFF timer activated, and system stops.
(The timer setting no longer displays.)



Notes

- In the following cases, reset the clock (the time setting is kept in the memory).
 - The circuit breaker has been activated.
 - The power fails.

Timer Operation

■ To select the DAILY timer mode:

1 Press  to select the DAILY timer mode.

- Each time the button is pressed, the modes change as follows.

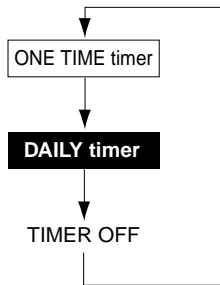

The timer lamp lights up.

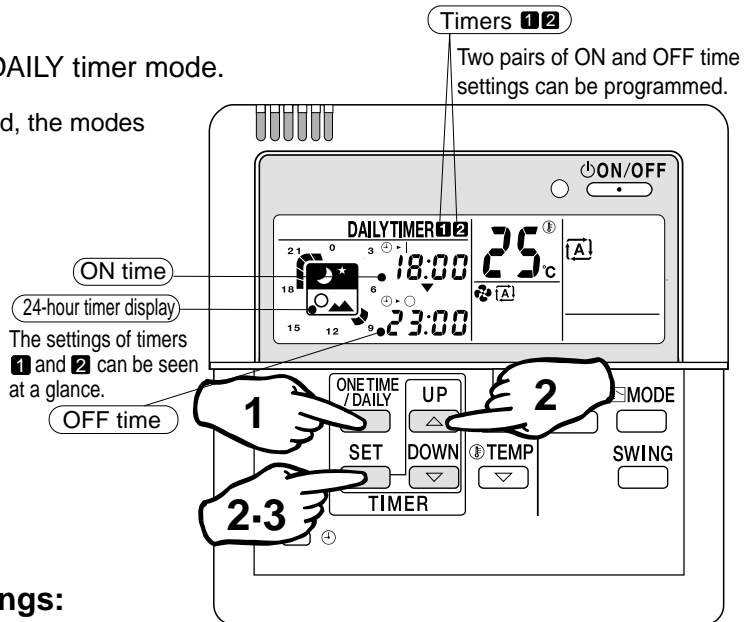

(Timer settings displayed)

■ To cancel the timer settings:

1 Press  to clear the timer settings.

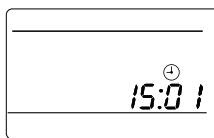

The **ONE TIME** or **DAILY TIMER**, and the timer lamp are no longer displayed.

Example of display with DAILY timer programmed



Timers **1** and **2** programmed.

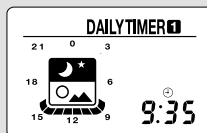

Timer **1** alone programmed.





Note

- The system starts and stops repeatedly until the DAILY timer is set off. Before you leave home for a long time, set the DAILY timer off.







■ DAILY timer

After programming, the system starts and stops each day at the preset times. Two pairs of time settings can be programmed.

(Example: 8:00 ~ 10:00, and 18:00 ~ 23:00)

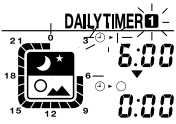
1 Press  to select the DAILY timer.  lights up. DAILY timer indication appears.

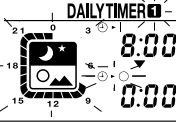
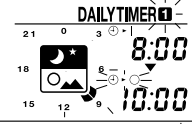
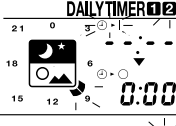
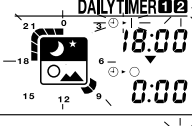
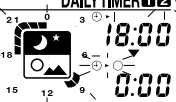
2 Make the ON and OFF time settings. ● Take the steps from ① to ⑧.
Program example: 8:00 ~ 10:00, and 18:00 ~ 23:00

| Settings | | Procedure | |
|----------|---|---|---|
| | | Press  | Press  to make the timer setting.  |
| Timer 1 | ON time setting ● When the timer 1 is not used, save the setting as ①-1- - - - | ①  | ②  |
| | OFF time setting | ③  | ④  |
| Timer 2 | ON time setting ● When the timer 2 is not used, save the setting as ⑤-1- - - - | ⑤  | ⑥  |
| | OFF time setting | ⑦  | ⑧  |

3 Press . The DAILY timer is now programmed.



Note

- If the following appears on the display, the timer must be reprogrammed.

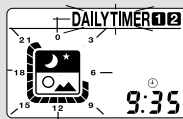

The 24-hour timer display is blinking.

This means that Timers 1 and 2 are programmed for the same time settings. New time settings must be made.



The 24-hour timer display is blinking.

This means that the timer has not been programmed yet.

Cleaning

Cleaning the remote controller

- Wipe it clean with soft, dry cloth.
Do not use any water hotter than 40°C (104°F), or volatile liquids such as benzine, gasoline and thinner, polishing powder, or anything hard such as a scrub brush.

When the unit is not used for a long time

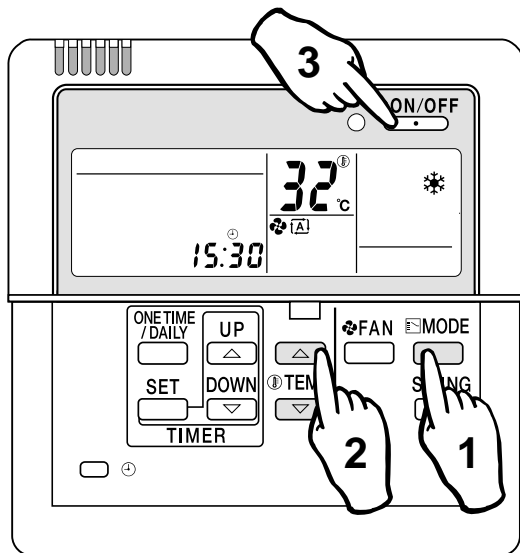

- ① On a sunny day, keep the system running for half a day in the FAN mode to dry it up inside.

FAN mode

- 1 Press to select the cooling mode.
 - 2 Press to adjust the set temperature to 32°C (90°F).
 - 3 Press .
 - The airflow rate remains the same, and is not adjustable.
 - Run the system when the room temperature is below 28°C (82°F).
- ② Finally turn off the circuit breaker dedicated for the room air conditioner.
 - ③ Clean the air filter and place it back into position.

2.5 <BRCW901A03/08> Wired Remote Controller Cord

Safety Precautions

- Turn OFF the controlled equipment when connecting the equipment.
- Hold the plug of the connector when connecting or disconnecting the connector.

Precautions for Use

- This remote controller cable is of thin-profile BRC944-series remote controller units.
- Be sure to ground both ends of the shield wire.
- Install the controlled equipment after reading through the installation manual of the equipment.

Complete Parts

• Remote Controller Cable

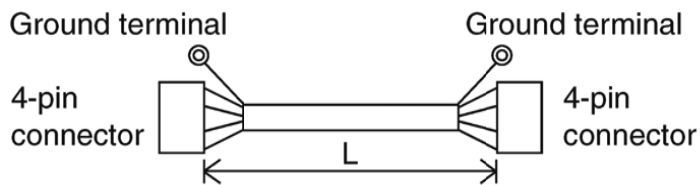

| Parts number | L |
|--------------|------------|
| BRCW901A03 | Approx. 3m |
| BRCW901A08 | Approx. 8m |

• Installation Manual



• Packing Case

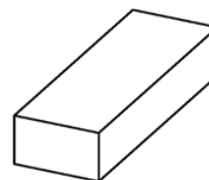

2.6 <KRP413BB1S> Wiring Adaptor

Safety Precautions

- Read these safety precautions carefully before installing the unit, and be sure to install the unit properly.
- This manual classifies precautions to the user into the following two categories. These warnings and cautions are for your safety. Follow them.

| | |
|------------------|--|
| ⚠ WARNING | Faulty installation can result in death or serious injury. |
| ⚠ CAUTION | Faulty installation can result in serious injury, damage to property, or other serious consequences. |

- After installation is complete, test the unit to confirm that it is working properly, and instruct the owner its proper use.

⚠ WARNING

- Installation should be left to the dealer from whom you purchased the unit, or another qualified professionals.
- Install the unit securely according to the installation manual. Faulty installation may lead to electric shock or fire.
- Be sure to use the supplied or specified parts. Using other parts may lead to electric shock or fire.
- Install the unit securely in a location that will support its weight. If installed in a poor location or improperly installed, the unit may not work as intended.
- For electrical work, follow local electric standards and the installation manual. Faulty installation may lead to fire or electric shock.
- Do not bundle the power cord, or attempt to extend it by splicing it with another cord or by using an extension cord. Do not place any other load on the power circuit used for the unit. Improper wiring may lead to electric shock, heat generation or fire.
- Use dedicated wiring for all electrical connections, and be sure to arrange the wiring so that force applied to the wiring will not damage the terminals. Poor wiring or installation may cause electric shock, heat generation or fire.

⚠ CAUTION

- Before installation, unplug the air conditioner to ensure safety. Failure to do so may cause electric shock.
- Static electricity may damage electric components. Before connecting cables and communication lines, and operating the switches, be sure to discharge any electrical charge from your body (by, for example, touching the earth line)
- Do not install the unit in a location where it may be exposed to flammable gases. If gas leaks and build up around the unit, it may catch fire.
- Do not place the wiring close to the power cord, inter-unit cable, or pipes which generate noise. Treat the wiring with care.

1. Functions and Features

- On/Off setting
- Switching between Instantaneous Contact/Normal Contact
- Connection with fan coil remote controller
- Automatic reset after power failure
- Output of normal operation signals/malfunction signals

2. Field Wiring

For interconnecting wiring, use Daikin KDC100A12 cable (not supplied) or other similar cable. Use a vinyl-covered wire or cable with four conductors each with a thickness of 0.2 to 1.25 mm².

■ Optional cable KDC100A12 (without connectors)

Specifications: 0.2 mm² × 4 core (sheathed)
 Outer diameter: φ5.3
 Length: 100 m
 Colour: Grey

Note : Keep any wiring for the control unit away from the power cord to prevent electrical noise.

Installation ①

1 Installation diagram

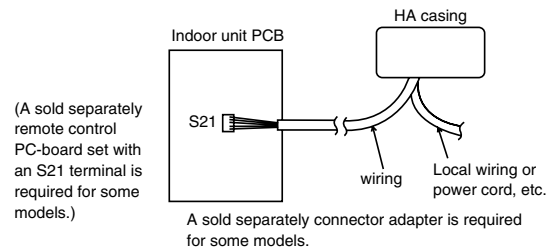

2 Components

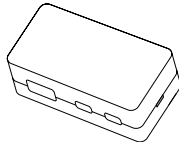
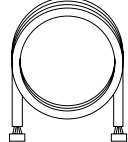
| | |
|--|---|
| ① HA casing ASSY (Remote Control PCB is attached in the HA casing.)  | ② Wiring (approx. 0.8 m) (Cannot be made longer.)  |
| ③ Accessories Binding band (6 pcs.) • Screws for attaching to the wall (3 pcs.) | |
| ④ Installation manual | |

Installation ②

Attaching HA Case ASSY

- Use the 3 supplied screws to attach the HA casing ASSY.

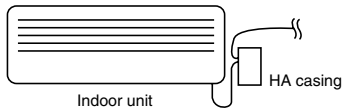

Install the HA casing ASSY as close to the indoor unit as possible.

① Removal of upper HA casing

- (1) Insert a flat-blade screwdriver into the groove between the upper and lower HA casings.

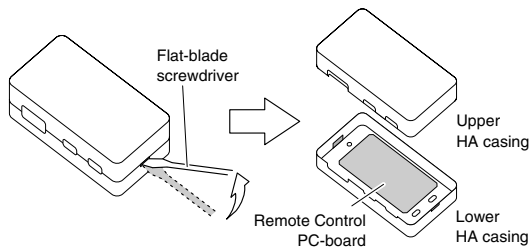

- (2) Lift the handle of the screwdriver upward.

- ② Mount and secure the lower HA casing directly on the wall with the provided screws inserted into the screw holes (a round hole and two ellipse holes) of the casing.

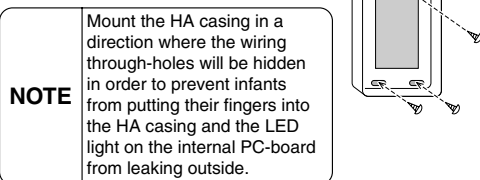

NOTE

Mount the HA casing in a direction where the wiring through-holes will be hidden in order to prevent infants from putting their fingers into the HA casing and the LED light on the internal PC-board from leaking outside.

- ③ After connecting the cables (refer to the following sections), replace the case front. Be careful not to damage the wiring in the case.

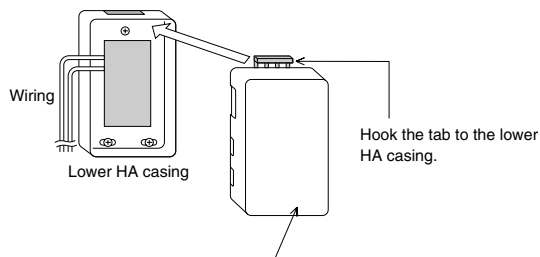

Press the lower part of the upper HA casing and press fit it onto the lower HA casing.
Press the upper HA casing precisely until a clicking sound is heard.

Wiring ①

1. Wiring

- ① Connect one end of the wiring to connector S21 of the PCB in the indoor unit.
- ② Connect the other end of the wiring to connector S6 of the Remote Control PCB.
- ③ Connect field wiring according to the functions assigned to each connection terminal of the Remote Control PCB.
- ④ Secure all wires.

1 Securing wires in the HA casing ASSY

① Connection of wiring

Connect the wiring to the connector terminals.

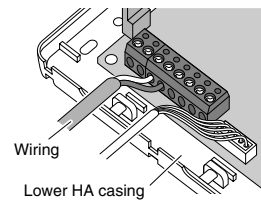

② Fixation of wiring

- (1) Insert the provided binding band under the pillar of the HA casing and secure the covers of the wiring with the binding band.

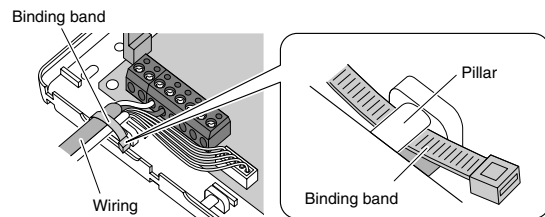

- (2) Insert the second binding band into the groove on the side of the HA casing and fix the wiring securely so that the wiring will not be disconnected.

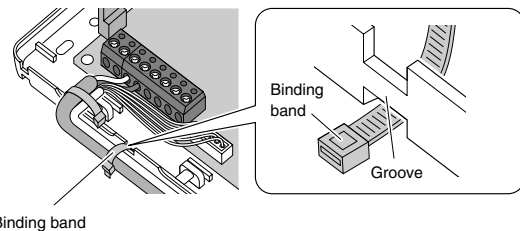

A large number of wires

Make a slit with an appropriate tool, such as a cutter knife, on the thin part of the upper HA casing along the frame. Then cut the part with an appropriate tool, such as a pair of nippers.

(NOTE) Cut off only the thin part required for wiring.

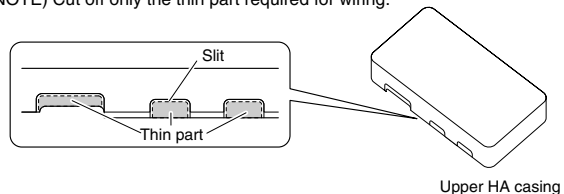

2 Securing wires in the indoor unit

- The method for securing wire varies depending on the model of the air conditioner. See your air conditioner installation manual for details.

Wiring ②

2. Automatic Reset After Power Failure

- This PCB stores the following data in the event of a power failure (the storage period is limitless).
 - ① On/Off (see Note 1)
 - ② Operation modes (see Note 2)
 - ③ Temperature setting
 - ④ Air flow rate
 - ⑤ On/Off status of remote controller
- (Note 1 When SW1-2 is in Off mode, the unit will not be activated.)
 (Note 2 The following settings apply to the models below.)

| | | |
|--|-------------|---------------|
| Mode before the power outage | COOLING | HEATING |
| Room air conditioner | | |
| Models with Humid heating and Reheating dehumidifying functions. | DRY COOLING | HUMID HEATING |
| Models with Reheating dehumidifying function. | | HEATING |

(Note 3 Not all settings will be saved (e.g., humidity or swing settings will not be saved).)

3. Monitor Signal Output (normal operation and malfunction)

- Maximum length of the wiring is 100 m. No external power supply is required.

1 Monitor signal output for LED

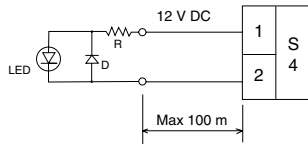

Locally procured parts

| Item | Manufacturer | Type |
|------|--------------|--------------|
| LED | Rohm | SLR-342 |
| D | Rohm | 1SS133 |
| R | | 510 ohm 1/4W |

2 Monitor signal output (normal operation and malfunction) using external relay contacts

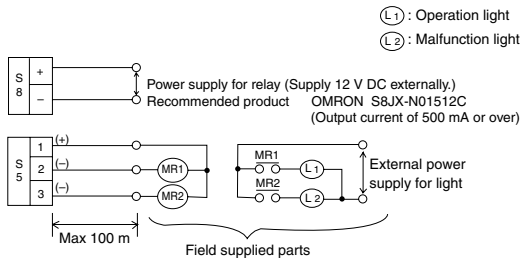

Field procured parts (Recommended external relay contacts)

| Manufacturer | Type | Coil rated voltage | Coil resistance |
|--------------|----------|--------------------|-----------------|
| Omron | MY relay | 12 V DC | 160 ohm ± 10% |

4. Connection with Remote Controller

Example connections with three kinds of remote controllers are shown below. Note: These connections cannot be used in combination.

1 Remote control with switch (field supply)

- Set SW1-1 to Off and select Operation Mode 1.



<Instantaneous Contact>

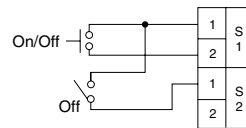

- The remote controller most recently used (local or air conditioner) takes precedence.
- Use a remote controller with a pulse width of 100 msec or more.

<Normal Contact>

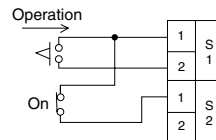

- Power On/Off cannot be controlled from the unit's remote controller. (Three beeps for signal reception will be heard continuously when the wireless remote controller is operated.)
- When power is restored after a power failure in this mode, On or Off is determined according to the current settings of the remote controller.

2 Fan coil remote controller

- Set SW1-1 to On and select Operation Mode 2.
- Most settings (power On/Off, air flow rate, mode change) cannot be made using the air conditioner's remote controller.
- When power is restored after a power failure in this mode, On or Off is determined according to the current settings of the remote controller.
- When the Cooling/Heating mode is changed, use the air conditioner's remote controller to adjust the temperature.

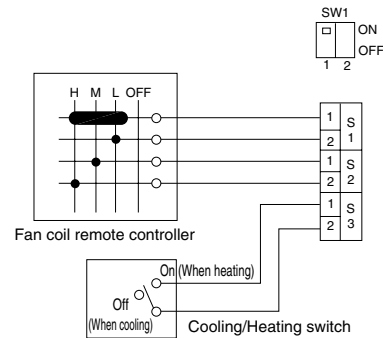

Test Operation and Confirmation

1. When the System is Not Working

- Is the air conditioner working properly?
- Are the connectors of the wiring properly connected?
- Are the remote controller and field wiring properly connected?
- Are all switch settings correct?
- If there is nothing apparently wrong, conduct a diagnostic check using the following procedure.

■ Diagnostic check

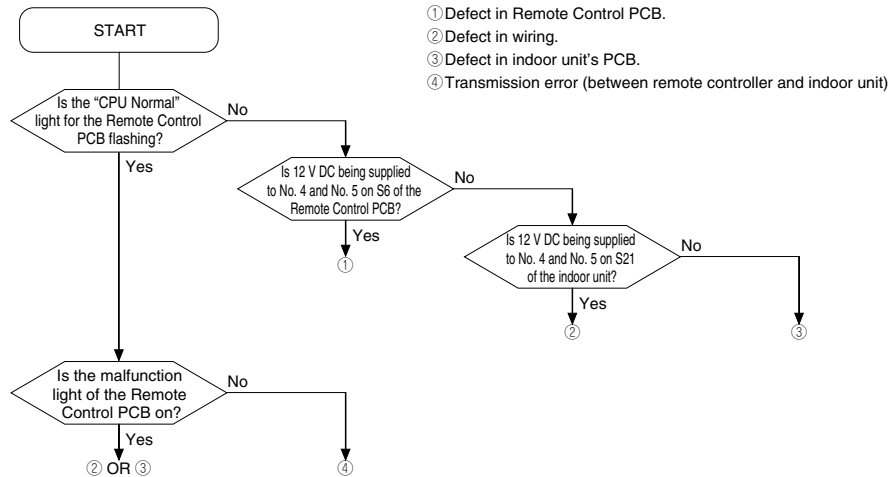

2. Switch Settings and Connection Terminals

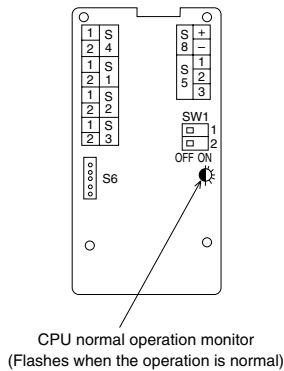

| | | | | | |
|----------------|---|--|--|---------------------------------|-------------------------|
| SW1-1 | Selecting the operation mode | OFF | Operation mode 1 (Used with the exception of fan coil remote controller settings) | | |
| | | ON | Operation mode 2 (Used with fan coil remote controller settings) | | |
| SW1-2 | Selecting On/Off when power is restored after a power failure | OFF | Always Off | | |
| | | ON | Off if operation was in Off mode before power failure; On if operation was in On mode before power failure | | |
| S1 S2 S3 | SW1-1: OFF (Operation mode 1) | S1 (1) - S2 (1) | | Instantaneous contact OPEN | Normal contact CLOSE |
| | | S1 (1) - S1 (2) | | Pulse input On/Off switching | OPEN, Not activated |
| | | S2 (2), S3 | | | CLOSE, Activated |
| | | S2 (2), S3 | | Not used | |
| | | S1, S2 OPEN | | Not activated | |
| | SW1-1: ON (Operation mode 2) | S1 (1) - S1 (2) CLOSE | | On, airflow: L tap | |
| | | S1 (1) - S2 (1) CLOSE | | On, airflow: M tap | |
| | | S1 (1) - S2 (2) CLOSE | | On, airflow: H tap | |
| | | S3 (With the remote controller only) | OPEN | Cooling | |
| | | | CLOSE | Heating | |
| S4 | (1) - (2) | Voltage on (12 V DC), normal operation light output | | | |
| S5 | (1) - (2) | Normal operation light output (power for light required) | | | |
| | (1) - (3) | Malfunction light output (power for light required) | | | |
| S6 connector | | Connect with connector S21 on the PCB of the indoor unit | | | |
| S8 | (+) - (-) | Relay 12 V DC power supply terminal (Field supplied parts) | | | |

2.7 <DCS302C71> Central Remote Controller (Installation)

Please read the **SAFETY CONSIDERATIONS** in this section carefully. Always wear your safety glasses and use proper techniques when working with electrical wiring. If you are not familiar with electrical wiring, please contact a qualified electrician. The manufacturer is not responsible for any damage or injury caused by improper installation or use of the unit. The manufacturer is not responsible for any damage or injury caused by the use of the unit.

Please read the following instructions:

- ▲ WARNING** Installation operation should not be carried out by unqualified personnel. If you are not familiar with electrical wiring, please contact a qualified electrician.
- ▲ CAUTION** The unit should be installed in a well-ventilated area. Do not install the unit in a place where it will be exposed to direct sunlight or rain.
- ▲ NOTE** The unit should be installed in a well-ventilated area. Do not install the unit in a place where it will be exposed to direct sunlight or rain.

▲ WARNING

Ask your dealer or qualified personnel to carry out installation work. Do not try to install the machine by yourself. The responsibility for any damage or injury caused by the installation is not ours.

Perform installation work in accordance with this installation manual.
 Important installation instructions are given in the following sections.

Be sure to use only the specified accessories and parts for installation work.
 Failure to do so may cause the unit to malfunction or to be damaged.

Carry out the specified installation work after taking into account strong winds, typhoons or earthquakes.
 Important installation instructions are given in the following sections.

Make sure that a separate power supply circuit is provided for the unit and that all electrical work is carried out by qualified personnel according to local laws and regulations and this installation manual.
 Failure to do so may cause the unit to malfunction or to be damaged.

Make sure that all wiring is secured, the specified wire is used, and no external force acts on the terminal connections or wires.
 Failure to do so may cause the unit to malfunction or to be damaged.

When wiring the power supply and connecting the remote controller wiring and transmission wiring, position the wires so that the electric parts box lid can be securely fastened.
 Failure to do so may cause the unit to malfunction or to be damaged.

Before touching electrical parts, turn off the unit.

Ground the air conditioner. Do not connect the ground wire to gas or water pipes, lightning rod or a telephone ground wire.
 Failure to do so may cause the unit to malfunction or to be damaged.

When installing or recharging the system, be sure to keep the refrigerant circuit free from gas, bacteria or other than the specified refrigerant (R410A), such as air.

Do not reconstruct or change the settings of the protection devices.
 Failure to do so may cause the unit to malfunction or to be damaged.

Do not touch the switch with wet fingers.
 Failure to do so may cause the unit to malfunction or to be damaged.

Install an leak circuit breaker, as required.
 Failure to do so may cause the unit to malfunction or to be damaged.

Do not install the air conditioner or the remote controller in the following locations:
 1. Places where the unit is exposed to direct sunlight or rain.
 2. Places where the unit is exposed to strong winds or typhoons.
 3. Places where the unit is exposed to strong vibrations or shocks.
 4. Places where the unit is exposed to high humidity or steam.
 5. Places where the unit is exposed to high temperatures.
 6. Places where the unit is exposed to high altitudes.
 7. Places where the unit is exposed to high noise levels.
 8. Places where the unit is exposed to high electromagnetic interference.
 9. Places where the unit is exposed to high dust levels.
 10. Places where the unit is exposed to high salt levels.
 11. Places where the unit is exposed to high acid levels.
 12. Places where the unit is exposed to high alkaline levels.
 13. Places where the unit is exposed to high oil levels.
 14. Places where the unit is exposed to high grease levels.
 15. Places where the unit is exposed to high dirt levels.
 16. Places where the unit is exposed to high pollen levels.
 17. Places where the unit is exposed to high mold levels.
 18. Places where the unit is exposed to high bacteria levels.
 19. Places where the unit is exposed to high virus levels.
 20. Places where the unit is exposed to high allergen levels.

▲ CAUTION

Be very careful about product transportation.

Safely dispose of the cooling materials.
 The unit should be disposed of in accordance with local regulations. Do not dispose of the unit in a landfill or incinerator.
 Failure to do so may cause the unit to malfunction or to be damaged.

Do not turn off the power immediately after stopping operation.
 Failure to do so may cause the unit to malfunction or to be damaged.

▲ NOTE

Install the indoor and outdoor units, power supply wiring and connecting wires at least 3.5ft. away from telephones or radios in order to prevent huge interference or noise.
 Failure to do so may cause the unit to malfunction or to be damaged.

Remote controller (wireless kit) transmitting distance can result shorter than expected in rooms with electronic fluorescent lamps (inverter or rapid start type).
 Failure to do so may cause the unit to malfunction or to be damaged.

The unit is a class A product.
 Failure to do so may cause the unit to malfunction or to be damaged.

Dismantling of the unit, treatment of the refrigerant, or eventual other parts, should be done in accordance with the relevant local and national regulations.

4 INITIAL SETTING

Refer to Figure 2 for wiring connections of the MXM-A, MXT-A, MXTH-A series. For details on the initial setting, refer to the initial setting manual of the controller.

1. Controller for setting master controller (M/A)
 - When using only 1 central remote controller, do not adjust the connection for setting master controller. Use the unit with the greatest number of stations as right unit.
 - When using multiple central remote controllers, set the right unit as right unit by connecting with the initial controller to which the station addresses, which are indicated in the table.

Table 1: Initial setting address for right unit
 Table 2: Initial setting address for left unit

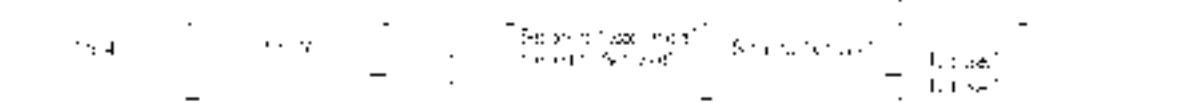

Then connect the connection for the central remote controller, the on/off terminal, and the substrate when connecting the unit together with the VFD. Refer to the basic wiring statement of the VFD for details. The VFD includes the wiring terminal arrangement in the recalled interface station.

2. Address setting

The address setting can be made as follows. **SYSTEM CONFIGURATION** is set on panel display (page 128) and address is set. The address can be set by setting the address setting address (SS3).

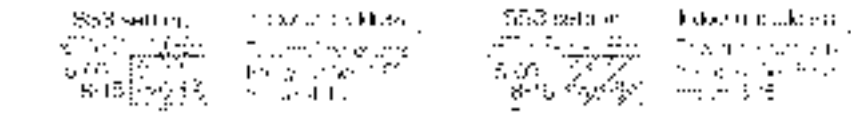

3. MAIN SUB change (on panel setting)
 With two central remote controllers, centralized control mode can be selected from different locations in the initial setting. It is necessary to set the MAIN SUB change over switch.

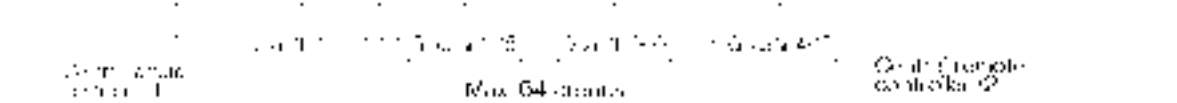

One of the two central remote controllers (1) is set to 'MAIN' while the other is set to 'SUB'.

4. Setting of the sequential operation function
 The central remote controller is equipped with a sequential operation function that sequentially turns on each output of 2 outputs (output 1 and 2) in order from 1 to 2. The sequential operation (ON or OFF) set as follows.

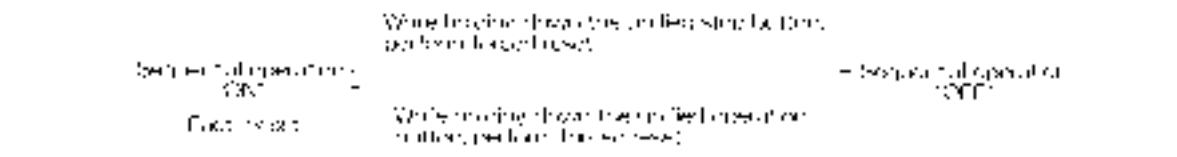





NOTE: The sequential operation function depends on the type of the power supply equipment. In cases that a converter that compresses will not be started simultaneously, the converter will not start even if a quantity is output (OFF) by power supply equipment to the motor selection.

5. Power on method
 When giving the power setting of the converter for setting master controller, the converter will start by setting it to the reset mode and pushing the power key to give the power without turning the power OFF.
 For initial operation, set this switch to the normal state.



6 SETTING GROUP NO. FOR CENTRALIZED CONTROL

Set the group number of operation group of the power unit from the remote controller. The group of the remote controller also requires the same function also. Set the group No. If set, use size this remote controller.

- Turn ON the power of the indoor unit and the outdoor unit separately.
 Turn on the power in CHARGE setting. Turn ON mode.
 Check that the indoor unit and outdoor unit are connected before turning the power supply ON.
 When the power supply is turned ON, the CL display comes and the unit enters the operation for about one minute with the display of "AG".
- Make in the normal mode. Push power button  with the remote controller 4 seconds.
 The remote controller will display "LED SET MOD".
- Select the MOD. Set OFF with the  button.
- Use the  button to set the group for the remote control.
 Group numbers, reverse to the order of 1 (00), 01, 02, 03, 04, 05, 06, 07, 08, 09, 10.
- Press  to set the selected group No.
- Press  to return to the NORMAL MODE.

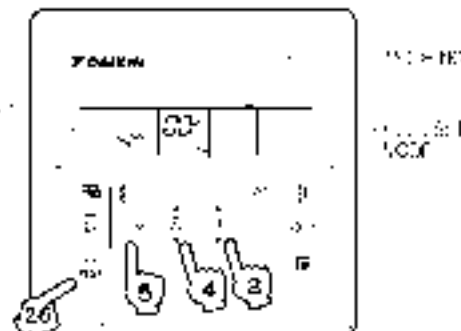



NOTES

- For the similar remote controls for the other air conditioner.
- Set the mode of the remote controller to the Normal mode (operation No. 1) to be used as a remote control for the indoor unit. (Group No. 00-10).

NOTE2 For the remote control, which is provided for power unit, to be installed, turn on the operation group of Remote to keep the operation manual for a reference.

7 TEST OPERATION (Perform a test operation in the Individual screen before registering zones.)

Before starting test operation, check that the power is supplied to the indoor unit, outdoor unit, and external remote controller.

- Select the display "INDIVIDUAL".
 Press  button to display "INDIVIDUAL".
- Select the group to test (test):
 Select the group for which to test (00, 01, 02, 03, 04, 05, 06, 07, 08, 09, 10).
- Press  button to select the test operation mode.
 "TEST" is displayed.
 "TEST" is used as the remote controller.
- Press  button with 10 seconds after entering to the test operation mode.
 Operation time: 300 minutes.
 When operation time is finished, the unit is in operation.
 If the operation time is over, it presents a malfunction.
 Call the product function manual, or call the call center, and check the reason of malfunction.
 The operation manual list of error codes can refer to it.



NOTES

- For test operation, refer to the installation manual about the operation.
- After turning the power supply ON, the unit may not start operation for some minutes at a time with the display of "00". Check the following points.
 - Check the installation of the power for the indoor unit and remote controller is correct.
 - Check that the remote control for indoor unit is set.

2.8 <DCS302C71> Central Remote Controller (Operation)

BEFORE USE

■ GENERAL DESCRIPTION OF SYSTEM

This central remote controller can monitor and control up to 64 indoor unit groups.
Using two central remote controllers allows monitoring and controlling of up to 128 indoor unit groups.

Main Functions

1. Batch starting and stopping of indoor units connected to the central remote controller.
2. Handling of operation settings such as start/stop, timer operation, remote controller prohibition/permission, etc., and operation status settings such as temperature.
3. Operation status monitoring of operation mode, set temperature, etc.
4. Can be connected to an external central monitor panel and key system using the forced stop input (non-voltage a connector).

- When using 1 central remote controller

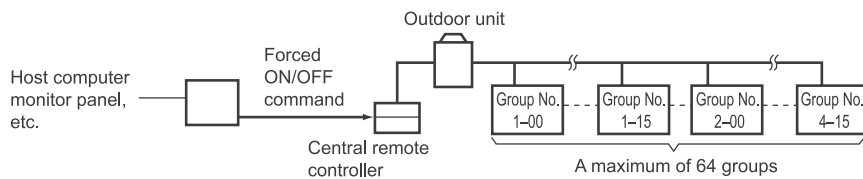

- When using 2 central remote controllers

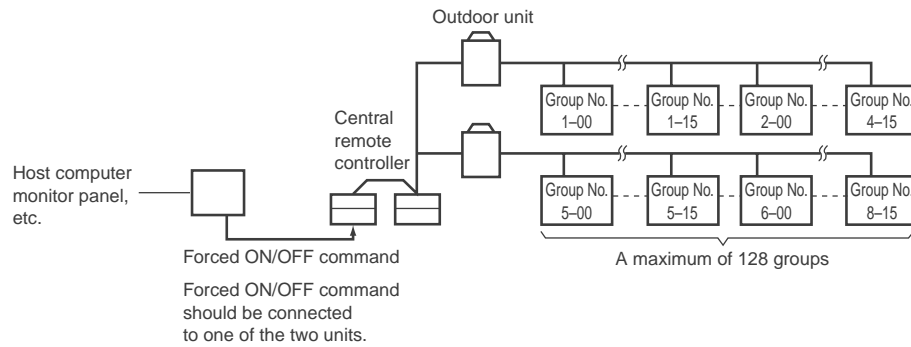

(The central remote controller and the separately sold remote control adapter circuit board or group remote control adapter cannot be used together.)

* GROUP OF INDOOR UNIT refers to the below.

1. A single indoor unit without remote controller

1. A single indoor unit without remote controller

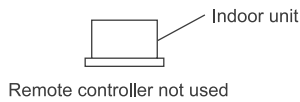

2. A single indoor unit controlled by one or two remote controllers

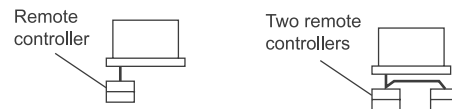

3. Maximum of 16 indoor units, group-controlled by one or two remote controllers

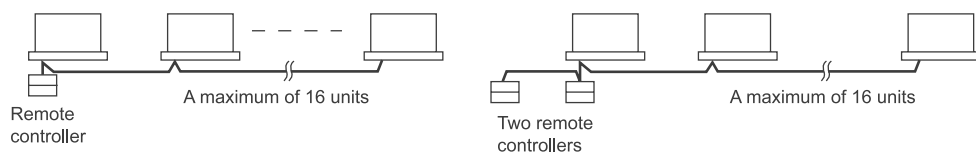

*** Zone control from the central remote controller**

Zone control is available from the central remote controller. With it, it is possible to make unified settings for multiple groups, so setting operations are greatly simplified.

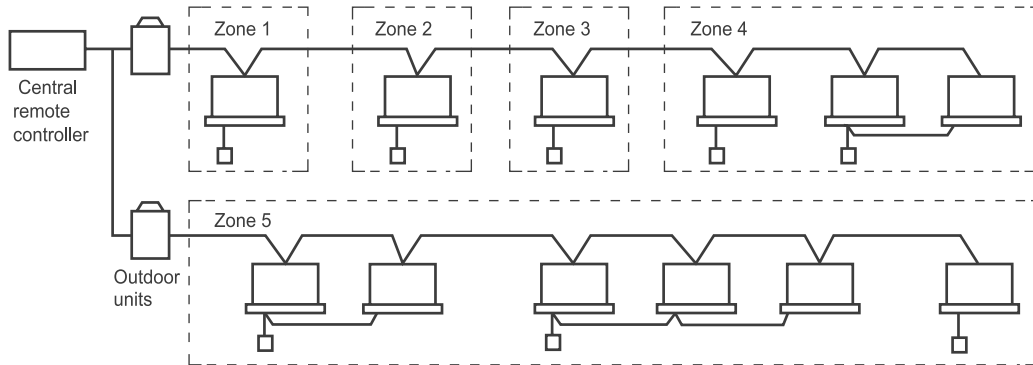

- Any setting you make within a given zone will apply to all groups in the said zone.
- A maximum of 64 zones can be set from a single central remote controller. (Each zone contains a maximum of 64 groups.)
- Zones can be set randomly from the central remote controller.

SAFETY CONSIDERATIONS

Please read these “SAFETY CONSIDERATIONS” carefully before installing air conditioning equipment and be sure to install it correctly. After completing the installation, make sure that the unit operates properly during the start-up operation. Please instruct the customer on how to operate the unit and keep it maintained. Also, inform customers that they should store this installation manual along with the operation manual for future reference. This air conditioner comes under the term “appliances not accessible to the general public”.

Meaning of danger, warning, caution and note symbols.

- ! DANGER** Indicates an imminently hazardous situation which, if not avoided, will result in death or serious injury.
- ! WARNING** Indicates a potentially hazardous situation which, if not avoided, could result in death or serious injury.
- ! CAUTION** Indicates a potentially hazardous situation which, if not avoided, may result in minor or moderate injury. It may also be used to alert against unsafe practices.
- ! NOTE**..... Indicates situation that may result in equipment or property-damage-only accidents.

Keep these warning sheets handy so that you can refer to them if needed.
Also, if this equipment is transferred to a new user, make sure to hand over this operation manual to the new user.

! DANGER

- **Any abnormalities in the operation of the air conditioner such as smoke or fire could result in severe injury or death.** Turn off the power and contact your dealer immediately for instructions.
- **Do not install the unit in an area where flammable materials are present due to risk of explosion resulting in serious injury or death.**
- **Safely dispose of the packing materials.** Packing materials, such as nails and other metal or wooden parts, may cause stabs or other injuries. Tear apart and throw away plastic packaging bags so that children will not play with them. Children playing with plastic bags face the danger of death due to suffocation.

! WARNING

- **Ask your dealer for installation of the air conditioner.** Incomplete installation performed by yourself may result in a water leakage, electric shock, and fire.
- **Ask your dealer for improvement, repair, and maintenance.** Incomplete improvement, repair, and maintenance may result in a water leakage, electric shock, and fire.
- **Improper installation or attachment of equipment or accessories could result in electric shock, short-circuit, leaks, fire or other damage to the equipment. Be sure only to use accessories made by Daikin which are specifically designed for use with the equipment and have them installed by a professional.**
- **Ask your dealer to move and reinstall the air conditioner or the remote controller.** Incomplete installation may result in a water leakage, electric shock, and fire.
- **Never let the indoor unit or the remote controller get wet.** It may cause an electric shock or a fire.

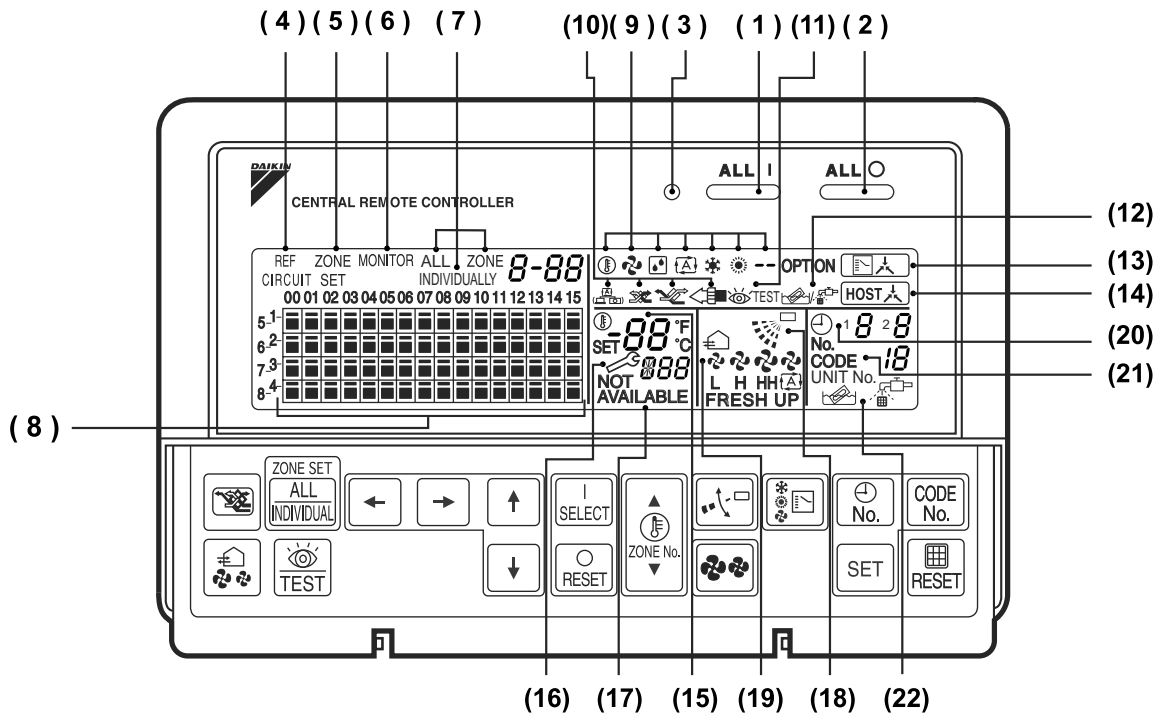

Fig. 1

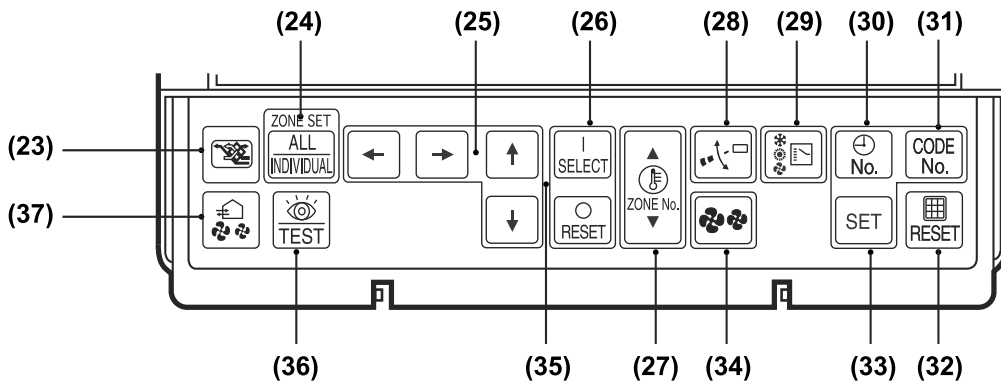

Fig. 2

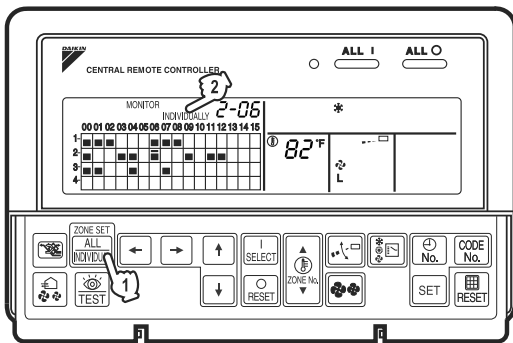

Fig. 3

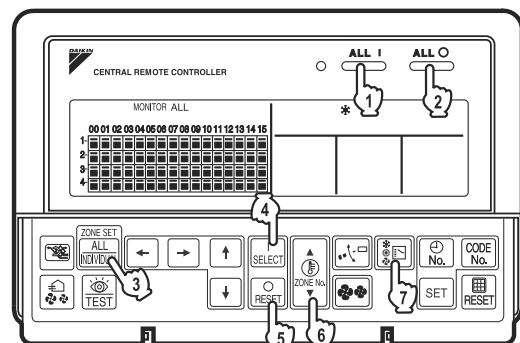

Fig. 4

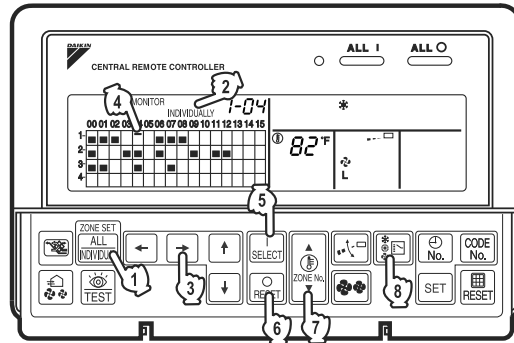

Fig. 5

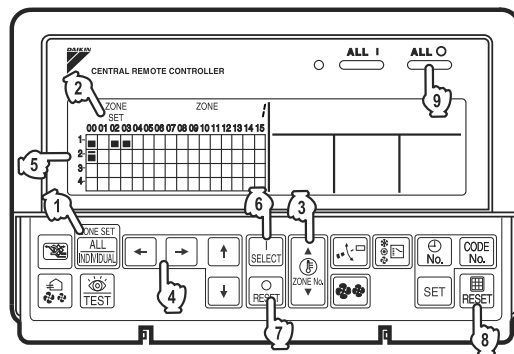

Fig. 6

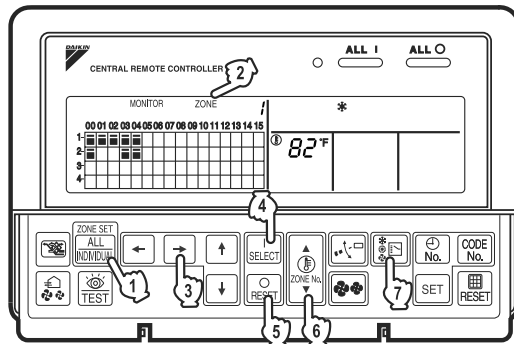

Fig. 7

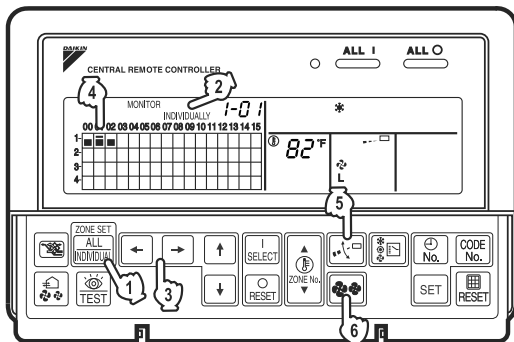

Fig. 8

- **Never use flammable spray such as hair spray, lacquer or paint near the unit.**
It may cause a fire.
- **Do not allow children to play on or around the unit as they could be injured.**
- **Never replace a fuse with that of wrong ampere ratings or other wires when a fuse blows out.**
Use of wire or copper wire may cause the unit to break down or cause a fire.
- **Never inspect or service the unit by yourself.**
Ask a qualified service person to perform this work.
- **Cut off all electric waves before maintenance.**
- **Do not wash the air conditioner or the remote controller with excessive water.**
Electric shock or fire may result.
- **Do not touch the switch with wet fingers.**
Touching a switch with wet fingers can cause electric shock.
- **Never touch the internal parts of the controller.**
Do not remove the front panel because some parts inside are dangerous to touch. In addition, some parts may be damaged by touching. For checking and adjusting internal parts, contact your dealer.
- **Check the unit stand for damage on a continuous basis, especially if it had been in use for a long time.**
If left in a damaged condition the unit may fall and cause injury.
- **Placing a flower vase or other containers with water or other liquids on the unit could result in a shock hazard or fire if a spill occurs.**

CAUTION

- **Avoid placing the controller in a spot splashed with water.**
Water coming inside the machine may cause an electric leak or may damage the internal electronic parts.

- **Do not operate the air conditioner when using a room fumigation - type insecticide.**
Failure to observe could cause the chemicals to become deposited in the unit, which could endanger the health of those who are hypersensitive to chemicals.
- **Do not turn off the power immediately after stopping operation.**
Always wait at least five minutes before turning off the power. Otherwise, water leakage and trouble may occur.
- **The appliance is not intended for use by young children or infirm persons without supervision.**
- **The remote controller should be installed in such a way that children cannot play with it.**

NOTE

- **Never press the button of the remote controller with a hard, pointed object.**
The remote controller may be damaged.
- **Never pull or twist the electric wire of the remote controller.**
It may cause the unit to malfunction.
- **Do not place the controller exposed to direct sunlight.**
The LCD display may get discolored, failing to display the data.
- **Do not wipe the controller operation panel with benzene, thinner, chemical dustcloth, etc.**
The panel may get discolored or the coating peeled off. If it is heavily dirty, soak a cloth in water-diluted neutral detergent, squeeze it well and wipe the panel clean. And wipe it with another dry cloth.
- **Dismantling of the unit, treatment of the refrigerant, oil and eventual other parts, should be done in accordance with the relevant local and national regulations.**

CONTENTS

| | |
|--|--|
| <p>BEFORE USE 1</p> <p style="padding-left: 20px;">GENERAL DESCRIPTION OF SYSTEM 1</p> <p>SAFETY CONSIDERATIONS 2</p> <p>FEATURES AND FUNCTIONS 6</p> <p>NAMES AND FUNCTIONS OF THE OPERATING SECTION 7</p> <p>OPERATION..... 8</p> <p style="padding-left: 20px;">Individual screen, all screen, zone screen 8</p> <p style="padding-left: 20px;">Batch operation and stop method 9</p> <p style="padding-left: 20px;">Group operation and stop method..... 9</p> <p style="padding-left: 20px;">Registering zones..... 9</p> <p style="padding-left: 20px;">Zone operation and stop method 10</p> <p style="padding-left: 20px;">Changing the fan direction and fan strength 11</p> <p style="padding-left: 20px;">Changing the ventilation mode and ventilation strength 11</p> <p style="padding-left: 20px;">Timer Number Setting 11</p> <p style="padding-left: 20px;">Setting the Operation Code..... 12</p> | <p>OPERATION MODE 13</p> <p style="padding-left: 20px;">Setting operation mode16</p> <p style="padding-left: 20px;">Group monitoring16</p> <p style="padding-left: 20px;">Error diagnosing function17</p> <p style="padding-left: 20px;">Setting master remote controller20</p> <p style="padding-left: 20px;">Display of time to clean21</p> <p>INSTALLATION TABLE 22</p> <p>OPTIONAL ACCESSORIES..... 23</p> <p>DOUBLE CENTRAL REMOTE CONTROLLERS 23</p> <p>SPECIFICATIONS..... 24</p> <p style="padding-left: 20px;">Specifications24</p> <p style="padding-left: 20px;">Outline drawings24</p> <p style="padding-left: 20px;">Fig. 1, 2, 3, 4.....3</p> <p style="padding-left: 20px;">Fig. 5, 6, 7, 8.....4</p> <p style="padding-left: 20px;">Fig. 9, 10, 11, 12.....25</p> <p style="padding-left: 20px;">Fig. 13, 14, 15, 16.....26</p> |
|--|--|

FEATURES AND FUNCTIONS

■ Operation menu

This central remote controller can operate and stop machines by either group or zone.
Batch operation and batch stop functions are also available. When used in combination with the schedule timer (optional accessory), timer operation and stop functions are available.



See page 8—12.

■ Various operation modes.

You can operate the system from both this unit and the remote controller, so to enable various operation control patterns. Twenty different operation modes are available including five operation patterns:

1. Start/stop: remote controller prohibition, remote controller stop-only permission, central priority, after-press priority, remote controller permission timer
2. Operation modes: remote controller prohibition, remote controller permission
3. Set temperature: remote controller prohibition, remote controller permission



See page 13—15.

■ Zone control for simpler setting procedures

You can control a maximum of 64 groups of indoor units by using this central remote controller. You don't have to repeat the same setting operations by group because you can make each of the following settings by zone.

A functions is available for setting all groups in one batch.

- Operation mode
- Control mode
- Setting temperature
- Programming time No. (Used in conjunction with the schedule timer)



See page 8—16.

■ Monitoring all indoor unit information

The following information can be displayed by group.

- Operation information such as operation mode, set temperature, etc., for indoor units
- Maintenance information such as cleaning signs for filters or elements
- Error codes and other malfunction diagnosis information



See page 16—21.

■ Function of refrigerant system display

This display helps you understand, at a glance, the indoor units sharing the same outdoor unit and the particular indoor unit among them that is set as the master remote controller.





See page 20.

- Room air conditioners and multi-purpose air conditioners may also be connected by using separately-sold adapter boards.
This may limit functionality, so consult the manuals that come with each adapter board.

NAMES AND FUNCTIONS OF THE OPERATING SECTION (Fig. 1, 2)

| | |
|----|--|
| 1 | UNIFIED OPERATION BUTTON |
| | Press to operate all indoor units. |
| 2 | UNIFIED STOP BUTTON |
| | Press to stop all indoor units. |
| 3 | OPERATION LAMP (RED) |
| | Lit white any of the indoor units under control is in operation. |
| 4 | “^{REF} CIRCUIT” DISPLAY (REFRIGERANT SYSTEM DISPLAY) |
| | This indication in the square is lit while the refrigerant system is being displayed. |
| 5 | “^{ZONE} SET” DISPLAY (ZONE SETTING) |
| | The lamp is lit while setting zones. |
| 6 | “MONITOR” DISPLAY (OPERATION MONITOR) |
| | The lamp is lit while operation is being monitored. |
| 7 | “ALL” “ZONE” “INDIVIDUALLY” DISPLAY |
| | The status displays indicates either batch functions or which zone or individual unit (or group) are being used. |
| 8 | OPERATION MONITOR |
| | Each square displays the state corresponding to each group. |
| 9 | “” “” “” “” “” “” “” “--” DISPLAY (OPERATION MODE) |
| | Displays operating state. |
| 10 | “” “” “” “” DISPLAY (VENTILATION CLEANING DISPLAY) |
| | This is displayed when a Venti air total enthalpy heat exchanger unit or other such unit is connected. |
| 11 | “ TEST” DISPLAY (INSPECTION/TEST) |
| | Pressing the maintenance/test run button (for service) displays this. This button should not normally be used. |
| 12 | “ / ” DISPLAY (TIME TO CLEAN) |
| | It lights up when any individual unit (group) has reached the time for the filter or element to be cleaned. |

| | |
|----|---|
| 13 | “” DISPLAY (COOLING/HEATING SELECTION PRIVILEGE NOT SHOWN) |
| | For zones or individual units (groups) for which this is displayed, cooling and heating cannot be selected. |
| 14 | “HOST ” DISPLAY (UNDER HOST COMPUTER INTEGRATED CONTROL) |
| | While this display is lit up, no settings can be made. It lights up when the upper central machines are present on the same air conditioning network. |
| 15 | “^{SET} 88°F” DISPLAY (PRESET TEMPERATURE) |
| | Displays the preset temperature. |
| 16 | “ U4” DISPLAY (MALFUNCTION CODE) |
| | This displays (flashes) the content of errors when an error failure has occurred. In maintenance mode, it displays the latest error content. |
| 17 | “NOT AVAILABLE” DISPLAY (NO FUNCTION DISPLAY) |
| | If a function is not available in the indoor unit even if the button is pressed, “NOT AVAILABLE” is may be displayed for a few seconds. |
| 18 | “” DISPLAY (FAN DIRECTION SWING DISPLAY) |
| | This displays whether the fan direction is fixed or set to swing. |
| 19 | “ L” “ H” “ HH” “” “FRESH UP” DISPLAY (VENTILATION STRENGTH/SET FAN STRENGTH DISPLAY) |
| | This displays the set fan strength. |
| 20 | “ No.” DISPLAY (TIME NO.) |
| | Displays the operation timer No. when used in conjunction with the schedule timer. |

| | |
|----|--|
| | “ CODE UNIT No. 18 ” DISPLAY (OPERATION CODE AND UNIT NUMBER DISPLAY) |
| 21 | The method of operation (remote controller prohibited, central operation priority after-press operation priority, etc.) is displayed by the corresponding code. This displays the numbers of any indoor units which have stopped due to an error. |
| 22 | “  ” “  ” DISPLAY (TIME TO CLEAN AIR CLEANER ELEMENT/ TIME TO CLEAN AIR FILTER) Displayed to notify the user it is time to clean the air filter or air cleaner element of the group displayed. |
| 23 | VENTILATION MODE BUTTON This is pressed to switch the ventilation mode of the total enthalpy heat exchanger. |
| 24 | ALL/INDIVIDUAL BUTTON Pressing this button scrolls through the “all screen”, “zone screen”, and “individual screen”. |
| 25 | ARROW KEY BUTTON This button is pressed when calling an individual indoor unit or a zone. |
| 26 | ON/OFF BUTTON Starts and stops ALL, ZONE, and INDIVIDUAL units. |
| 27 | TEMPERATURE ADJUSTMENT BUTTON (ZONE NUMBER BUTTON) This button is pressed when setting the temperature. Select the zone number if any zones have been registered. |
| 28 | FAN DIRECTION ADJUSTMENT BUTTON This button is pressed when setting the fan direction to “fixed” or “swing”. |
| 29 | OPERATION MODE SELECTOR BUTTON This sets the operation mode. The dry setting cannot be done. |
| 30 | TIME NO. BUTTON Selects time No. (Use in conjunction with the schedule timer only). |
| 31 | CONTROL MODE BUTTON Selects control mode. |
| 32 | FILTER SIGN RESET BUTTON This button is pressed to erase the “clean filter” display after cleaning or replacement. |

| | |
|----|---|
| 33 | SET BUTTON Sets control mode and time No. |
| 34 | FAN STRENGTH ADJUSTMENT BUTTON Pressing this button scrolls through “weak”, “strong”, and “fast”. |
| 35 | ZONE SETTING BUTTON Zone registration mode can be turned on and off by pressing the start and stop buttons simultaneously for at least four seconds. |
| 36 | INSPECTION/TEST RUN BUTTON (FOR SERVICE) Pressing this button scrolls through “inspection”, “test run”, and “system display”. This button is not normally used. |
| 37 | VENTILATION STRENGTH ADJUSTMENT BUTTON This button is pressed to switch the ventilation strength (“fresh up”) of the total enthalpy heat exchanger. |

(Notes)

1. Please note that all the displays in the figure appear for explanation purposes or when the cover is open.
2. If the unit is used in conjunction with other optional central controllers, the OPERATION LAMP of the unit that is not under operation control may light up and go out a few minutes behind schedule. This shows that the signal is being exchanged, and does not indicate any failure.

OPERATION

■ Individual screen, all screen, zone screen (Fig. 3)

This controller can perform operations in the individual screen, all screen, or zone screen.

- Individual screen The individual screen is used when performing group operations.
- All screen The all screen is used when performing operations for all units at once.
- Zone screen The zone screen is used when performing zone operations.

1. Select the screen by pressing the “ALL/INDIVIDUAL” button.

 Every time the “ALL/INDIVIDUAL” button is pressed, the selection scrolls through INDIVIDUAL → ALL → ZONE.
If nothing is done in the all or zone screens for one minute, it automatically goes to the individual screen.

- If the zone number in the zone screen is displayed as “--,” this indicates that no units are registered in a zone.
Please perform zone registration before proceeding in the zone screen. (See page 9)

■ Batch operation and stop method (Fig. 4)

This is for operating or stopping all connected units at once.

A. What to do when operating or stopping all connected units at once.

1. Press either  “ALL I” or

 “ALL O”.

- Operation can be performed from the individual screen, the all screen, or the zone screen.
- The “TEMPERATURE ADJUSTMENT” and “OPERATION MODE SELECTOR” buttons cannot be used.
To set the temperature and operation mode, use B. batch operation.

B. Batch Operation

1.  Press the “ALL/INDIVIDUAL button” to enter the all screen.

The “” display lights up on all registered units.



2.  Press the “SELECT” button.

The “” display lights up on all connected units.

 Press the “RESET” button.

The “” display goes off on all connected units. Operation and stop in the batch screen are done the same as with the batch operation and batch stop buttons.

3.  Press the “TEMPERATURE ADJUSTMENT” button.

The temperature rises 1° every time the () button is pressed.
The temperature drops 1° every time the () button is pressed.

Set to “--” when you do not wish to use batch setting for the temperature setting.
Setting to 1° above or below the temperature setting range displays “--”.

4.  Call up the desired mode by pressing the “OPERATION MODE SELECTOR” button.

Set to “--” when you do not wish to use batch setting for the operation setting.

■ Group operation and stop method (Fig. 5)



This is for operating or stopping connected units in groups.

[Group operation]

1. Press the  “ALL/INDIVIDUAL button”

to enter the  individual screen.

The unit will enter the individual screen automatically if nothing is done for one minute.

2.  Using the arrow keys,  move the “” to select the units to operate or stop.

Keeping the button pressed down will move it rapidly.

The “” in this screen has selected unit 1-04.

3.  Press the “SELECT” button.

The “” display lights up in the group.

 Press the “RESET” button.

The “” display goes off in the group.

4.  Press the “TEMPERATURE ADJUSTMENT” button.

The temperature rises 1° every time the () button is pressed.

The temperature drops 1° every time the () button is pressed.

Temperature adjustment cannot be done if the selected group’s air conditioners are in fan mode.

5.  Call up the desired mode by pressing the “OPERATION MODE SELECTOR” button.

■ Registering zones (Fig. 6)

It is possible to set multiple groups as one zone and control each zone separately.
No zones are registered when the unit is shipped from the factory.

Zone registration can be done in the individual screen, all screen, or zone screen.

[Registration]

1.  Pressing the “ALL/INDIVIDUAL” button for four seconds.  Displays ZONE SET.

Zone Number 1 will be displayed, and if there are any groups already registered in the displayed zone, a “” will light up on the operation monitor.

2. Select the Zone Number to be registered using the “ZONE NUMBER” button. Keeping the button pressed down will move it rapidly.
3. “” to the group you wish to register using the arrow keys. Keeping the button pressed down will move it rapidly.
4. Press the “SELECT” button to register that group to the zone.
The “” display lights up on all the selected units.
 Pressing the “RESET” button removes the group from that zone, and “” goes off.
Repeat steps 3 and 4 until all the units you wish to register to the zone have been added.

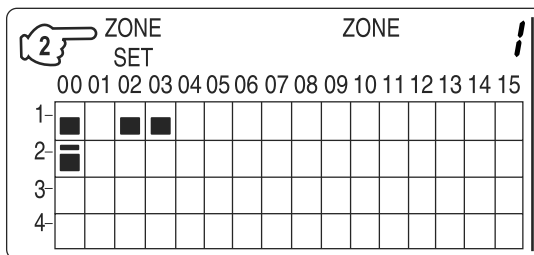

In this example, a screen is shown with units 1-00, 1-02, 1-03, and 2-00 registered to Zone Number 1.

5. Repeat steps 2 to 4 to register to the next zone.
6. Once zone registration is complete, press the “ALL/INDIVIDUAL” button to turn off “ZONE SET” display and return to the individual screen.
The display returns to the normal screen if nothing is done for one minute when in zone registration mode.
(NOTE)
 - It is impossible to register one group to several different zones. If this is done, the last zone registered to will be valid.

[Batch deletion of zone registration]

1. Pressing the “ALL ○” for at least four seconds while pressing the “FILTER SIGN RESET” button when “ZONE SET” is displayed will delete all zone registrations.
The zone registrations for all units will be lost.

■ Zone operation and stop method (Fig. 7)

This is for operating or stopping connected units in zones.

[Zone operation]

1. Press the “ALL/INDIVIDUAL button” to enter the zone screen.
2. Using the arrow keys, select the zone number to operate or stop.

Pressing and reduces the zone number while and raise the number. Keeping the button pressed down will move it rapidly.

- If the zone number is displayed as “--,” this indicates that no units are registered in a zone. Please perform zone registration before using a zone. (See page 9)

3. Press the “SELECT” button.

The “” display lights up in the group.

4. Press the “RESET” button.

The “” display goes off in the group.

4. Press the “TEMPERATURE ADJUSTMENT” button.

The temperature rises 1° every time the (▲) button is pressed.

The temperature drops 1° every time the (▼) button is pressed.

Set to “--” when you do not wish to use zone setting for the temperature setting.

Setting to 1° above or below the temperature setting range displays “--”.

5. Call up the desired mode by pressing the “OPERATION MODE SELECTOR” button.

Set to “--” when you do not wish to use zone setting for the operation mode.

■ Changing the fan direction and fan strength (Fig. 8)

This changes the fan direction and strength settings in the air conditioner.

Changing the fan direction and strength is done in the individual screen.

[Registration]

1. Press the “ALL/INDIVIDUAL button” to enter the individual screen.

The unit will enter the individual screen automatically if nothing is done for one minute.

2. Using the arrow keys, move the “” to select the units to fan direction adjustment or fan strength adjustment.

Keeping the button pressed down will move it rapidly.

3. Press the “FAN DIRECTION ADJUSTMENT” button.

This sets “fixed” or “swing” for the fan direction.

- Press the “FAN STRENGTH ADJUSTMENT” button.

Pressing this button scrolls through “”, “”, and “”.

Depending on the indoor unit, only “” and “” may be available.

The functions included in the indoor units may vary. Pressing a button for a function which is not available will cause “NOT AVAILABLE” to be displayed.

■ Changing the ventilation mode and ventilation strength (Fig. 9)

This changes the ventilation mode and strength settings in the total enthalpy heat exchanger.

Changing the ventilation mode and strength is done in the individual screen.

[Registration]

1. Press the “ALL/INDIVIDUAL button” to enter the individual screen.

The unit will enter the individual screen automatically if nothing is done for one minute.

2. Using the arrow keys, move the “” to select the units to ventilation mode or ventilation strength adjustment.

Keeping the button pressed down will move it rapidly.

3. Press the “VENTILATION MODE” button.

It will scroll through “” → “” → “” → “”.

- Press the “VENTILATION STRENGTH ADJUSTMENT” button.

It will scroll through “” → “” → “” →

“” → “”.

The fresh up function may not be available depending on the connected unit model.

The functions included in the indoor units may vary. Pressing a button for a function which is not available will cause “NOT AVAILABLE” to be displayed.

• Ventilation Mode and Amount

If these are changed using the remote controller depending on the unit model, they cannot be displayed on the central remote controller.

To monitor the ventilation mode and amount, check the values on the remote controller.

■ Timer Number Setting (Fig. 10)

(Only when used with the schedule timer)

Using this together with the schedule timer makes it possible to set on and off times four times a day.

[Registration]

1. Pressing the “TIMER NO.” button causes the number set for timer number 1 to blink.

If no timer setting has been made “-” will be displayed.

Select the desired timer number by pressing the “TIMER NO.” button.

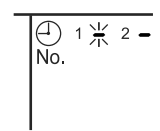

2. Once the desired timer number is displayed, press the “SET” button.

Press the “SET” button within 10 seconds after the timer number is displayed.

The display will return to how it was after 10 seconds.

The display for timer number 1

will stop blinking and then timer number 2 will start blinking.

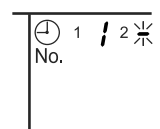

3.  Select the desired timer number by pressing the “TIMER NO.” button.

Once the desired timer number is displayed,  press the “SET” button.

The display for timer number 2 will stop blinking.

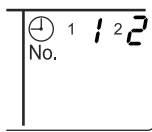

The “ No.” display will disappear after 3 seconds.

Select “-” in the timer number when you do not wish to set a timer number. It is possible to set only one timer number. (The times for turning the unit(s) on and off twice a day can be set with a single timer number.)

• Timer Number Setting

- Group control: select the unit in the individual screen and set the timer number.
- Batch control: set the timer numbers for all connected units.
- Zone control: set the timer numbers for all zone-registered units.
Call up the zones which you wish to set in the zone screen and set the timer numbers.

- **Since the timer number will be set to after-press priority, the timer number in the last screen set will be valid for the connected units.**

Example 1

Setting timer number 1 for unit 1-00 to “1” and timer number 2 to “2” in the individual screen and then setting timer number 1 to “3” and timer number 2 to “4” in the batch screen causes the timer numbers for all units to be set, so timer number 1 for unit 1-00 will be “3” and timer number 2 will be “4”.

Example 2

To prevent leaving units on, timer number 1 is set to “5” in the batch screen. Setting timer number 1 in zone number 1 to “-” in the zone screen after that will change the timer number for zone number 1, so the setting to prevent leaving the units on will be lost for zone number 1 only.

If a timer number is set incorrectly by accident, redo the setting in the desired screen.

- **What happens when the timer number on time and off time are set to the same time**

When the on time and off time are set to the same time for the same timer number, operation does not change.

When the on time and off time are set to the same time for different timer numbers, the off time is given priority.

When using timer operation, make sure the times do not overlap when setting the program of the schedule timer.

■ Setting the Operation Code (Fig. 11)

[Registration]

1.  **Pressing the “CONTROL MODE” button causes the currently set operation code to blink.**

Call up the desired code number by pressing the  “CONTROL MODE” button. Scroll through the code numbers.

2.  **Once the code number is displayed, press the “SET” button.**

The display will stop blinking. The operation code display will disappear after 3 seconds.

[The Operation Code Setting]

- Group control: select the unit in the individual screen and set the operation code.
- Batch control: set the operation code for all connected units.
- Zone control: set the operation code for all zone-registered units.
Call up the zones which you wish to set in the zone screen and set the operation code.

Since the operation code will be set for after-press priority, setting the operation code in the zone and individual screens after setting the operation code in the batch screen, will cause the operation codes set afterwards to be valid.

OPERATION MODE

The following five operation control modes can be selected along with the temperature setting and operation mode by remote controller, for a total of twenty different modes. These twenty modes are set and displayed with control modes of 0 to 19. (For further details, see **EXAMPLE OF OPERATION SCHEDULE** on the next page.)

- ON/OFF control impossible by remote controller..... Use this mode when operating and stopping from the central remote controller only. (ON/OFF control by the remote controller is disabled.)
- Only OFF control possible by remote controller Use this mode when executing the operation only by the central remote controller, and executing only the stop by remote controller.
- Centralized Use this mode when executing the operation only by the central remote controller, and executing start/stop freely by remote controller during the preset hours.
- Individual Use this mode when executing start/stop both by central remote controller and remote controller.
- Timer operation possible by remote controller..... Use this mode when executing start/stop by remote controller during the preset hours, and not starting operation by the central remote controller at the programmed time of system start.

[HOW TO SELECT THE CONTROL MODE]

- Select whether to accept or to reject the operation from the remote controller regarding the operation, stop, temperature setting and operation mode setting, respectively, and determine the particular control mode from the rightmost column of the table below.

Example

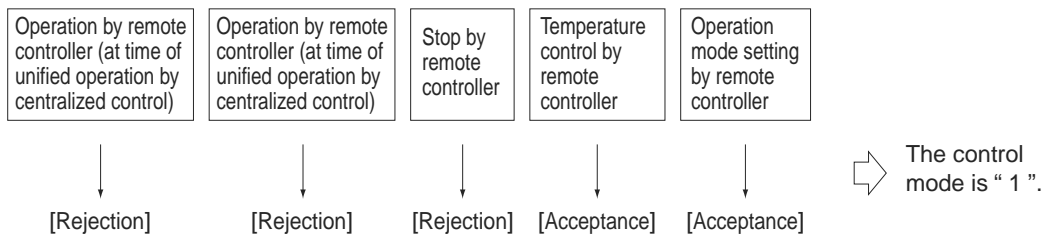

| Operation mode | Control by remote controller | | | | | Control mode |
|--|--|---|---------------------|----------------------|------------------------|--------------|
| | Operation | | Stop | Temperature control | Operation mode setting | |
| | Unified operation, individual operation by central remote controller, or operation controlled by timer | Unified stop, individual stop by central remote controller, or timer stop | | | | |
| ON/OFF control impossible by remote controller | Rejection (Example) | Rejection (Example) | Rejection (Example) | Rejection | Acceptance | 0 |
| Only OFF control possible by remote controller | | | | Acceptance (Example) | Rejection | 10 |
| Centralized | Acceptance | Acceptance | Acceptance | Rejection | Acceptance | 1 (Example) |
| Individual | | | | Acceptance | Rejection | 11 |
| Timer operation possible by remote controller | Acceptance (During timer at ON position only) | Rejection (During timer at OFF position) | Acceptance | Rejection | Acceptance | 2 |
| | | | | Acceptance | Rejection | 12 |
| | | | | Rejection | Acceptance | 3 |
| | | | | Acceptance | Rejection | 13 |
| | | | | Rejection | Acceptance | 4 |
| | | | | Acceptance | Rejection | 14 |
| | | | | Rejection | Acceptance | 5 |
| | | | | Acceptance | Rejection | 15 |
| | | | | Rejection | Acceptance | 6 |
| | | | | Acceptance | Rejection | 16 |
| | | | | Rejection | Acceptance | 7 |
| | | | | Acceptance | Rejection | 17 |
| | | | | Rejection | Acceptance | 8 |
| | | | | Acceptance | Rejection | 18 |
| | | | | Rejection | Acceptance | 9 |
| | | | | Acceptance | Rejection | 19 |

Note) Do not select the timer operation possible without the remote controller. In this case, timer operation is disabled.

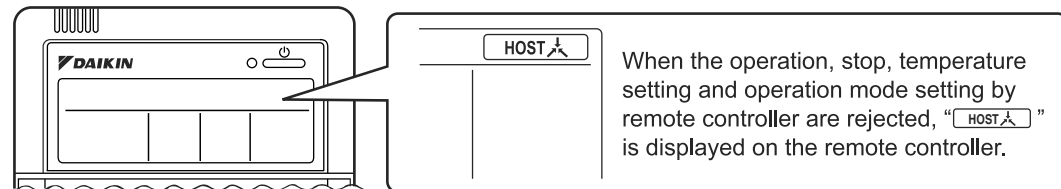

EXAMPLE OF OPERATION SCHEDULE

Operation schedule is possible only in conjunction with the schedule timer (optional accessory).

Liquid crystal display of schedule timer

ON/OFF control impossible by remote controller

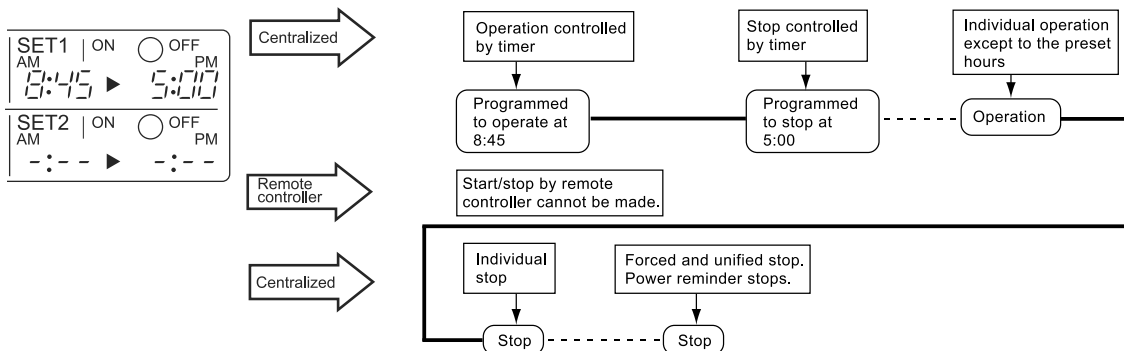

Only OFF control possible by remote controller

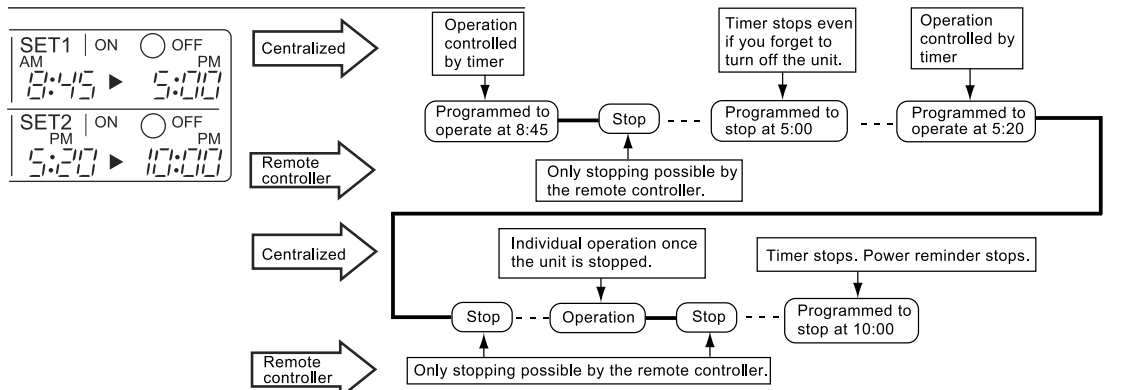

Centralized

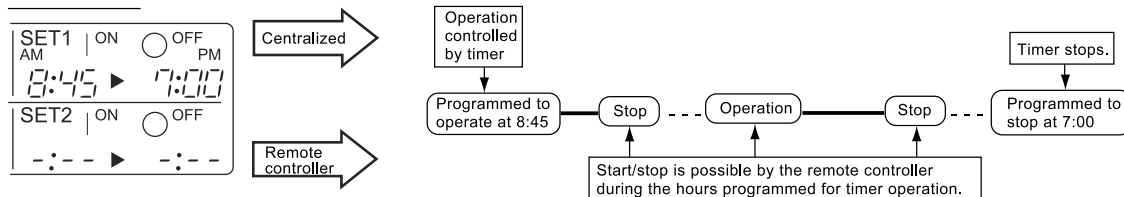

Individual

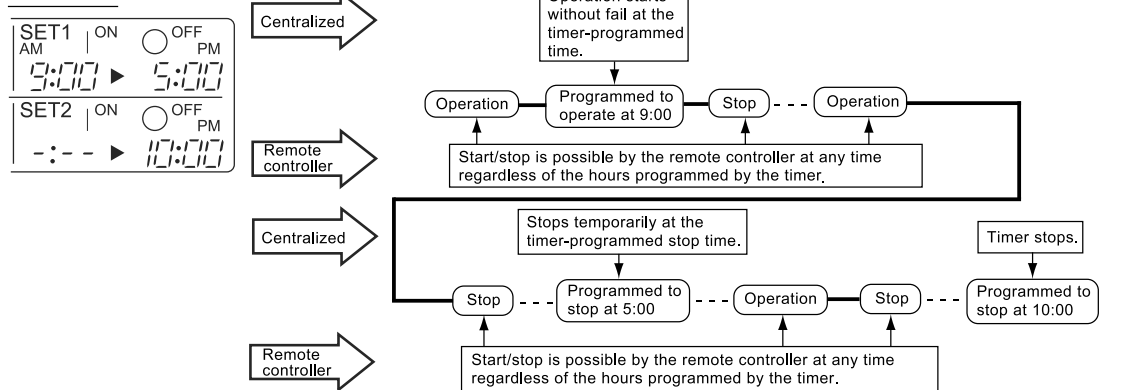

Timer operation possible by remote controller

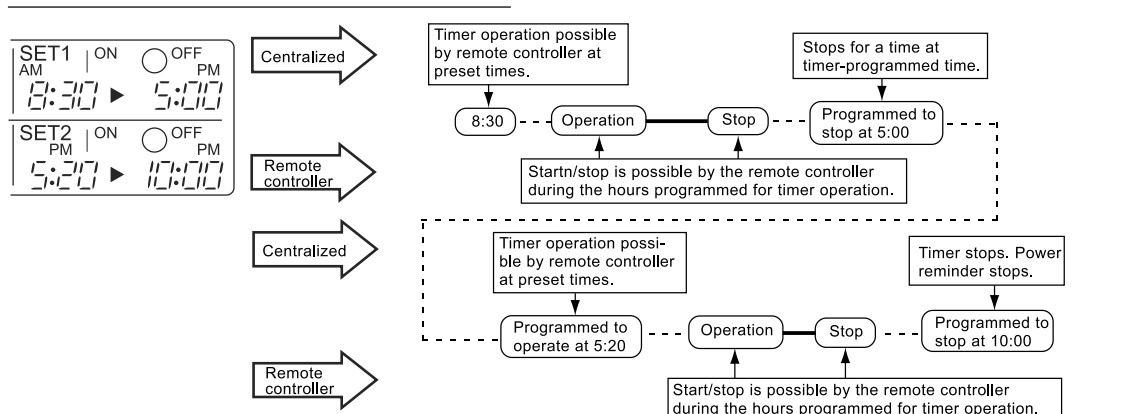

- Air conditioner now operating.
- - - - Air conditioner now stopping.
- ▭ Command by central remote controller
- Command by remote controller

■ **Setting operation mode (Fig. 12)**

[Registration]

1. Press the **OPERATION MODE SELECTOR BUTTON**. Each time you press this button, the display rotates as shown on the below list.

• **List of operations which can be set**

In the below list, “○” refers to the acceptable setting, while “x” refers to the not acceptable setting.

| Display | A: Zones and groups with no “” display. | |
|---------|---|---|
| | Setting | Contents of setting |
| | x | |
| | ○ | Can be set in individual zones or groups |
| | ○ * 1 | Can be set in individual zones or groups |
| | ○ | Can be set in individual zones or groups |
| | ○ | Can be set in individual zones or groups |
| | ○ * 1 | Can be set in individual zones or groups * 3 |
| | ○ * 1 | Can be set in individual zones or groups |
| | ○ | Select this display if you don't wish to set by zone. |

| Display | B: Zones and groups with a “” display. | |
|---------|--|---|
| | Setting | Contents of setting |
| | ○ | To be set by zone * 2 |
| | ○ | Can be set in individual zones or groups |
| | x | |
| | x | The displays are shown by group * 4 |
| | x | The displays are shown by group * 4 |
| | ○ * 1 | Can be set in individual zones or groups * 3 |
| | ○ * 1 | Can be set in individual zones or groups |
| | ○ | Select this display if you don't wish to set by zone. |

- *1: Setting may not be acceptable depending on the type of indoor unit with which this unit is connected.
- *2: In zone control, the units run in temperature adjustment mode (heating or cooling) for the outdoor system for the groups registered to those zones. Heating or cooling selection is not available.
- *3: or or Changing the ventilation mode cannot be done in the zone screen. Changing the ventilation mode should be done in the individual screen.
- *4: In group control, the units run in temperature adjustment mode (heating or cooling) for the group outdoor system. Heating or cooling selection is not available.

• **The Zone consists of the following two cases.**

A. Zone without display “”
 The group with master remote controller setting exists in this zone.
 Setting the master remote controller enables cool/heat selection.
 Operations other than cool/heat operations can also be set for some operations. For further details, see the list on the left.

B. Zone with display “”
 No group with master remote controller setting exists in this zone.
 The cool/heat selection is not available because the master remote controller has not been set.
 Some operations other than cool/heat operations can be set. For further details, see the list in the left.

See page 20 if the display “” is flashing.

- Fan operation can be performed for each zone using the central remote controller even if there is no cooling/heating selection right during cooling or heating. Also, if a VentiAir is connected in the zone, ventilation and ventilation cleaning operation is possible. See the included operating manuals for details.
- When the indoor unit is in heat operation, change the setting to FAN operation through the central remote controller; then, you can switch the fan speed to the extremely low fan speed. Warm air may blow if any other indoor unit belonging to the same system is in heat operation.
- The indoor fan stops during defrost/hot start.
- DRY cannot be set from the central remote controller.

■ **Group monitoring (Fig. 13)**

Utilize the group monitor function in each of the following cases:

1. Check the malfunction code. (See the next page.)
2. Check the group that requires cleaning of the air filter and air cleaner element. (See page 21.)
3. Change the setting of the master remote controller. (See page 20.)
4. Check the group(s) sharing the same outdoor unit. Or, check the particular group(s) with the master remote controller setting. (See page 20.)
5. Check the conditions of other individual groups.

When in zone screen

The zone screen will revert to the individual screen automatically if nothing is done in it for one minute.

[Registration]

1. Press the “ALL/INDIVIDUAL” button to switch to the “INDIVIDUAL” screen.

2. Using the arrow key, move the “ ” to select the unit to be monitored.

Keeping the button pressed down will move it rapidly.

The “ ” lights up and the status of that unit is displayed in the LCD. The cursor in the screen Fig. 13 has selected unit 2-06.

■ Error diagnosing function (Fig. 14)

This central remote controller is provided with a diagnosing function, for when an indoor unit stops due to malfunction. In case of actuation of a safety device, disconnection in transmission wiring for control or failure of some parts, the operation lamp, inspection display and unit No. start to flash; then, the malfunction

code is displayed. Check the contents of the display, and contact your DAIKIN dealer because the above signs can give you the idea on the trouble area.

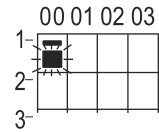

The display “ ” flashes under the group No. where the indoor unit that has stopped due to malfunction.

[Registration]

1. Press the ARROW KEY BUTTON to call up the group that has stopped due to malfunction.

The unit No. the malfunction code is flashing because of an error failure.

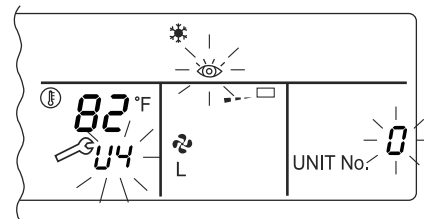

| Operation lamp | Maintenance display | Unit No. | Malfunction code | Error content |
|----------------|---------------------|----------|------------------|---|
| ☀ | ● | ⌘ | 64 | Indoor air thermistor error |
| ☀ | ● | ⌘ | 65 | Outdoor air thermistor error |
| ☀ | ● | ⌘ | 68 | HVU error (Ventiair dust-collecting unit) |
| ☀ | ● | ⌘ | 6A | Dumper system error |
| ⌘ | ⌘ | ⌘ | 6A | Dumper system error + Thermistor error |
| ☀ | ● | ⌘ | 6F | Simple remote controller error |
| ☀ | ● | ⌘ | 6H | Door switch (Ventiair dust-collecting unit), relay harness fault (Ventiair dust-collecting/humidifier unit) |
| ⌘ | ⌘ | ⌘ | 94 | Ventiair internal transmission error (between total enthalpy – fan unit) |
| ⌘ | ⌘ | ⌘ | A0 | Indoor unit · external safety device error |
| ⌘ | ⌘ | ⌘ | A1 | Indoor unit · BEV unit (Sky-Air connection unit) PC board assembly fault |
| ☀ | ● | ⌘ | A1 | Indoor unit · PC board assembly fault |
| ⌘ | ⌘ | ⌘ | A3 | Indoor unit · Drain level error (33H) |
| ⌘ | ⌘ | ⌘ | A6 | Indoor unit · Fan motor (51F) lock, overload |
| ☀ | ● | ⌘ | A7 | Indoor unit · Fan direction adjustment motor (MA) error |
| ⌘ | ⌘ | ⌘ | A9 | Indoor unit · BEV unit, electric expansion valve motor (20E) error |
| ☀ | ● | ⌘ | AF | Indoor unit · Malfunctioning drain |
| ☀ | ● | ⌘ | AH | Indoor unit · Dust-collector error |
| ⌘ | ⌘ | ⌘ | AJ | Indoor unit · Insufficient capacity setting, address setting fault |

| | | | | |
|---|---|---|-----------|--|
| ☼ | ☼ | ☼ | C4 | Indoor unit · Liquid piping thermistor (Th2) Error (faulty connection, cut wire, short circuit, fault) |
| ☼ | ☼ | ☼ | C5 | Indoor unit · BEV unit, gas piping thermistor (Th3) Error (faulty connection, cut wire, short circuit, fault) |
| ☼ | ☼ | ☼ | C9 | Indoor unit · Intake air thermistor (Th1) Error (faulty connection, cut wire, short circuit, fault) |
| ☼ | ☼ | ☼ | CA | Indoor unit · Outlet air thermistor (Th4) Error (faulty connection, cut wire, short circuit, fault) |
| ☼ | ● | ☼ | CJ | Indoor unit · remote controller sensor error |
| ☼ | ☼ | ☼ | E0 | Outdoor unit · Safety device operation |
| ☼ | ☼ | ☼ | E1 | Outdoor unit · PC board assembly fault |
| ☼ | ● | ☼ | E1 | Outdoor unit · PC board assembly fault |
| ☼ | ☼ | ☼ | E3 | Outdoor unit · High-pressure switch fault |
| ☼ | ☼ | ☼ | E4 | Outdoor unit · Low-pressure switch fault |
| ☼ | ☼ | ☼ | E9 | Outdoor unit · Electric expansion valve motor (20E) error |
| ☼ | ● | ☼ | EC | Heat source unit · Intake water temperature inter-lock operation (fan operation) |
| ☼ | ☼ | ☼ | EF | Outdoor unit · Ice thermal storage unit error |
| ☼ | ☼ | ☼ | F3 | Outdoor unit · Discharge piping temperature error |
| ☼ | ● | ☼ | H3 | Outdoor unit · High-pressure switch operation |
| ☼ | ☼ | ☼ | H4 | Outdoor unit · Low-pressure switch operation |
| ☼ | ☼ | ☼ | H9 | Outdoor unit · Outdoor air thermistor (Th1) Error (faulty connection, cut wire, short circuit, fault) |
| ☼ | ● | ☼ | H9 | Outdoor unit · Outdoor air thermistor (Th1) Error (faulty connection, cut wire, short circuit, fault) |
| ☼ | ● | ☼ | HC | Outdoor unit · Water temperature sensor system error |
| ☼ | ● | ☼ | HF | Ice thermal storage unit error, ice thermal storage controller error, error in outdoor unit during ice thermal storage operation |
| ☼ | ☼ | ☼ | HJ | Outdoor unit · water system fault |
| ☼ | ☼ | ☼ | J1 | Outdoor unit · pressure sensor error |
| ☼ | ☼ | ☼ | J3 | Outdoor unit · Discharge piping thermistor (Th3) Error (faulty connection, cut wire, short circuit, fault) |
| ☼ | ● | ☼ | J3 | Outdoor unit · Discharge piping thermistor (Th3) Error (faulty connection, cut wire, short circuit, fault) |
| ☼ | ☼ | ☼ | J5 | Outdoor unit · Intake piping thermistor (Th4) Error (faulty connection, cut wire, short circuit, fault) |
| ☼ | ☼ | ☼ | J6 | Outdoor unit · Heat exchange thermistor (Th2) error |
| ☼ | ● | ☼ | J6 | Outdoor unit · Heat exchange thermistor (Th2) error Error (faulty connection, cut wire, short circuit, fault) |
| ☼ | ☼ | ☼ | J7 | Outdoor unit · Header thermistor (Th6) error |
| ☼ | ☼ | ☼ | JA | Outdoor unit · Discharge piping pressure sensor error |
| ☼ | ☼ | ☼ | JC | Outdoor unit · Intake piping pressure sensor error |
| ☼ | ☼ | ☼ | JF | Outdoor unit · Oil temperature sensor (Th5) system error |
| ☼ | ● | ☼ | JH | Outdoor unit · Oil temperature sensor (Th5) system error |
| ☼ | ☼ | ☼ | L0 | Outdoor unit · Inverter system fault |
| ☼ | ☼ | ☼ | L4 | Outdoor unit · Inverter cooler fault |
| ☼ | ☼ | ☼ | L5 | Outdoor unit · Ground circuit for compressor motor, short circuit, or power unit short circuit |

| | | | | |
|--------|---|---|-----------|--|
| ☼ | ☼ | ☼ | L6 | Outdoor unit · Ground circuit for compressor motor, short circuit |
| ☼ | ☼ | ☼ | L8 | Outdoor unit · Compressor overload, compressor motor wire disconnection |
| ☼ | ☼ | ☼ | L9 | Outdoor unit · Compressor lock |
| ☼ | ☼ | ☼ | LA | Outdoor unit · Power unit error |
| ☼ | ☼ | ☼ | LC | Outdoor unit · Transmission error between inverter and outdoor control unit |
| ☼ or ● | ☼ | ☼ | M1 | Central controller: PC board fault |
| ☼ or ● | ☼ | ☼ | M8 | Transmission error between central controllers |
| ☼ or ● | ☼ | ☼ | MA | Central controller: Incorrect combination |
| ☼ or ● | ☼ | ☼ | MC | Central controller: Address setting fault |
| ☼ | ● | ☼ | P0 | Insufficient gas (thermal storage) |
| ☼ | ☼ | ☼ | P1 | Outdoor unit · Power voltage imbalance, phase loss |
| ☼ | ☼ | ☼ | P4 | Outdoor unit · Power unit temperature sensor error |
| ☼ | ● | ☼ | U0 | Pressure drop due to insufficient refrigerant, electric expansion valve fault, etc. |
| ☼ | ☼ | ☼ | U1 | Reversed or lost phase |
| ☼ | ☼ | ☼ | U2 | Power voltage error, momentary electrical stoppage |
| ☼ | ☼ | ☼ | U4 | Transmission error between indoor unit/BEV unit and outdoor/BS unit, Transmission error between outdoor unit and BS unit |
| ☼ | ☼ | ☼ | U5 | Transmission error between remote controller and indoor control unit |
| ● | ☼ | ● | U5 | Remote controller board fault or remote controller setting fault |
| ☼ | ☼ | ☼ | U6 | Transmission error between indoor units |
| ☼ | ☼ | ☼ | U7 | Transmission error between outdoor units Transmission error between outdoor unit and ice thermal storage unit |
| ☼ | ● | ☼ | U7 | Transmission error between outdoor units (cooling/heating batch, low-noise operation) |
| ☼ | ☼ | ● | U8 | Transmission error between master remote controller and slave remote controller (slave remote controller error) Incorrect combination of indoor unit and remote controller within a single system (model) |
| ☼ | ☼ | ☼ | U9 | Transmission error between indoor unit/BEV unit and outdoor unit within a single system Transmission error between BS unit and indoor unit/BEV unit and outdoor unit within a single system |
| ☼ | ☼ | ☼ | UA | Incorrect combination of indoor, BS, and outdoor units within a single system (model, number of units, etc.) Incorrect combination of indoor unit and remote controller (remote controller in question) BS unit connection position fault |
| ☼ | ● | ☼ | UC | Central control group numbers overlap |
| ☼ | ☼ | ☼ | UE | Transmission error between indoor unit and central controller |
| ☼ | ☼ | ☼ | UF | Unset system, incorrect settings between BEV unit and indoor unit |
| ☼ | ☼ | ☼ | UH | System fault |

■ error codes (in outline font) do not display “maintenance” and the system will run, but please check the content of the display and contact your dealer.

■ Setting master remote controller (Fig. 15)

You must set the master remote controller of the operation mode for one of the indoor units, if two or more such indoor units with the remote controller are connected with the outdoor unit where the operation modes such as cool/heat operation and FAN operation can be set by remote controller and central remote controller.

1. Preparations

When you want to fix settings

- Check the particular group with the master remote controller setting for the refrigerant system you wish to reset. (See the below.)
- Call up the group without the display

“” (See page 16.)

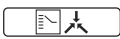

 Hold the OPERATION MODE SELECTOR BUTTON down for about four seconds while the above group is being called up.

The display “” flashes on the liquid crystal display of the remote controller for all the groups sharing the same outdoor unit or BS unit.

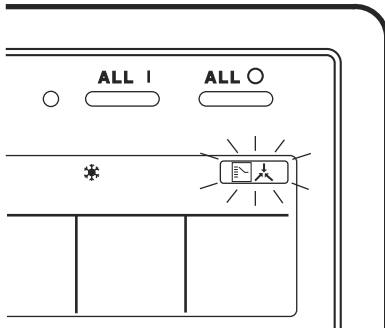
When you turn on the power switch for the first time, the display “” flashes.



2. Setting selection right

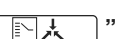

Call up the desired group to set the master remote controller, and  press the OPERATION MODE SELECTOR BUTTON. The master remote controller is set for this group, and the display “” goes out. The display “” appears for the other groups. Setting is finished now.

When switching operation



- In case of operation switch
Call up the zone including the group with the setting of master remote controller.

(Zone without the display “”)

 Press the OPERATION MODE SELECTOR BUTTON several times, and switch to the desired operation mode.

Each time you press it, the display is switched to “” “” “” and “--” in sequence.

NOTE

- However, the displays “” “” and “VENTILATION MODE” may appear in some zones, depending on the type on indoor unit with which they are connected.

(VENTILATION MODE)



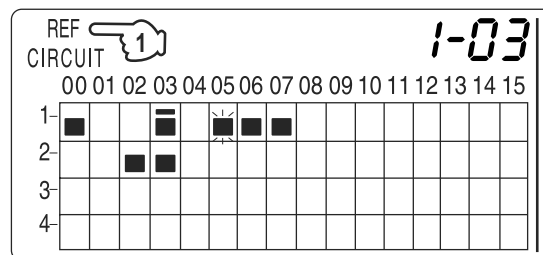

[System Display]

1. Test run mode is necessary to display the system display.
2. In order to turn on test run mode, select the appropriate air conditioner on the individual screen with the cursor and then set its operation mode to either cooling or heating. (It makes no difference if the air conditioner is running or not running while this operator is being performed.)
3. Press the “inspection/test run” button twice to put it into test run mode.
4. Pressing the “inspection/test run” button for four or more seconds in test run mode will display  the “REF CIRCUIT.”



Call the unit whose system you wish to look up using the arrow keys.

The “” on all groups in the same system as the displayed group will light up.

Of those, the “” display in all groups which have cooling/heating selection privilege will blink.

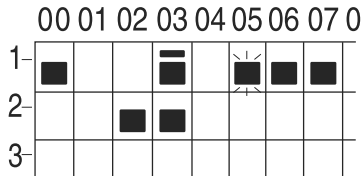

In this example, individual units 1-00, 1-03, 1-05, 1-06, 1-07, 2-02, and 2-03 are in the same system, and 1-05 has the cooling/heating selection privilege.

To look up other systems, call up all the units you wish to look up using the arrow keys.

Pressing the inspection/test run button one more time gets rid of the system display and ends it.

The unit will enter the individual screen automatically if nothing is done for one minute in the system display screen.



This function may not be available for all connected outdoor units, in which case “REF CIRCUIT” will blink. It will also not be correctly displayed if DIII-NET extension ADP is used.

■ Display of time to clean (Fig. 16)



This central remote controller displays the time to clean the air filter or air cleaner element for each group or any given group by utilizing two types of signs. The display “” tells the time to clean the air filter or the air cleaner element of some group.

If a cleaning sign is displayed

A filter or element in some group is ready to be cleaned.



1.  Press the **ARROW KEY BUTTON**, and search the groups displaying “” or “” (The group may be plural.)

Clean or change the air filter or air cleaner element.

For further details, see the operation manual attached to each indoor unit. (Clean or change the air filter or air cleaner element of all the groups displaying “” or “”.)

2.  Press the **FILTER SIGN RESET BUTTON**, and the display “” disappears. (Including all the groups where the air filter has been cleaned.)

NOTE

Be sure to check the display “” “” has disappeared at this point. The appearance of the above display is a sign that the air filter or air cleaner element of some group still needs cleaning.

INSTALLATION TABLE

When installing the equipment, mark the zone No. of each group and installation location in the below table.

Setting group No.

(Setting is not possible unless power is activated to both the central remote controller and indoor unit.)

Operated by remote controller

1. Activate power to both the central remote controller and indoor unit.
2. While in the normal mode, hold down the “

Operated by simplified remote controller

1. Activate power to both the central remote controller and indoor unit.
2. Remove the upper part of the remote controller.
3. Press the **BS6** BUTTON (field set) on the PC board. The controller will enter the FIELD SET MODE.
4. Select the MODE No. “

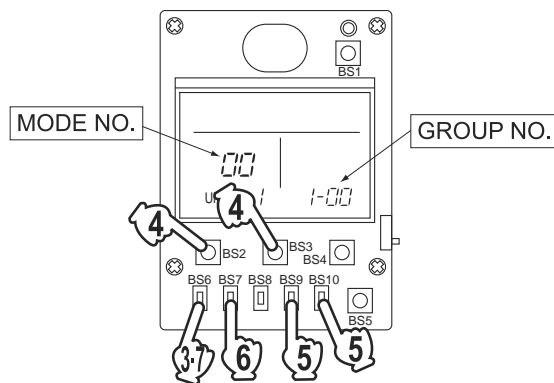

| | | | | | | | | | | | | | | | | |
|---|-----|-----|-----|-----|-----|-----|-----|-----|-----|-----|-----|-----|-----|-----|-----|-----|
| Zone No. | | | | | | | | | | | | | | | | |
| Group No. | -00 | -01 | -02 | -03 | -04 | -05 | -06 | -07 | -08 | -09 | -10 | -11 | -12 | -13 | -14 | -15 |
| Indoor unit Quantity of units Controlled by | | | | | | | | | | | | | | | | |
| Location | | | | | | | | | | | | | | | | |
| Zone No. | | | | | | | | | | | | | | | | |
| Group No. | -00 | -01 | -02 | -03 | -04 | -05 | -06 | -07 | -08 | -09 | -10 | -11 | -12 | -13 | -14 | -15 |
| Indoor unit Quantity of units Controlled by | | | | | | | | | | | | | | | | |
| Location | | | | | | | | | | | | | | | | |

| | | | | | | | | | | | | | | | | |
|---|-----|-----|-----|-----|-----|-----|-----|-----|-----|-----|-----|-----|-----|-----|-----|-----|
| Zone No. | | | | | | | | | | | | | | | | |
| Group No. | -00 | -01 | -02 | -03 | -04 | -05 | -06 | -07 | -08 | -09 | -10 | -11 | -12 | -13 | -14 | -15 |
| Indoor unit Quantity of units Controlled by | | | | | | | | | | | | | | | | |
| Location | | | | | | | | | | | | | | | | |
| Zone No. | | | | | | | | | | | | | | | | |
| Group No. | -00 | -01 | -02 | -03 | -04 | -05 | -06 | -07 | -08 | -09 | -10 | -11 | -12 | -13 | -14 | -15 |
| Indoor unit Quantity of units Controlled by | | | | | | | | | | | | | | | | |
| Location | | | | | | | | | | | | | | | | |

OPTIONAL ACCESSORIES

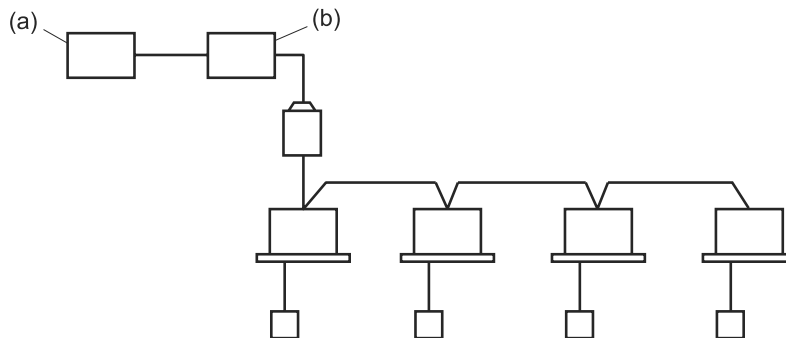

You can perform the normal operation, take off the malfunction contact point and unified start/stop by contact point, all by connecting this unit with the unification adaptor for computerized control. For further details, ask your DAIKIN dealer.

(a) Unification adaptor for computerized control (b) Central remote controller

DOUBLE CENTRAL REMOTE CONTROLLERS

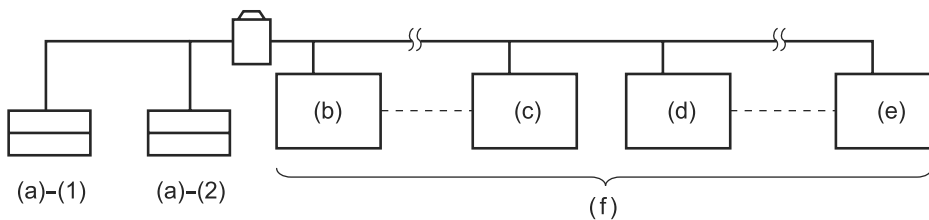

With two central remote controllers, centralized control (indoor units) is possible from different locations.

(a) Central remote controller (b) Group No. 1 - 00 (c) Group No. 1 - 15 (d) Group No. 2 - 00
 (e) Group No. 4 - 15 (f) A maximum of 64 groups

Note)

- For control alignment and settings for double central remote controllers, contact your dealer.

SPECIFICATIONS

■ Specifications

| | |
|---------------------|---|
| Power supply | 1 ~ 50/60Hz, 100V – 240V |
| Power consumption | Max. 8W |
| Forced ON/OFF input | Continuous "a" contact Contact current: approximately 10mA |
| Size | 180 (W) x 120 (H) x 64.5 (D) |
| Weight | 420g |

■ Outline drawings

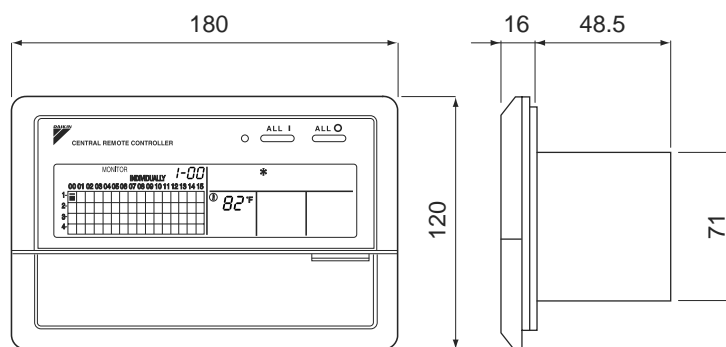

When using this unit an electric parts box of KJB311A is required.
For installation, a steel electric parts box to be embedded is mandatory.

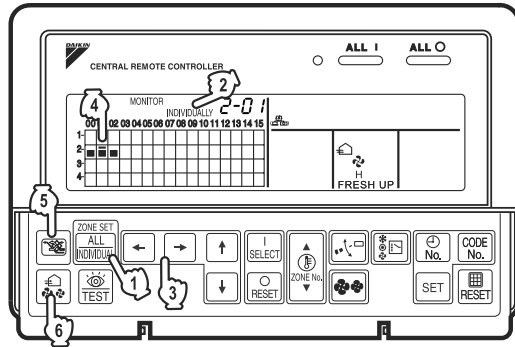

Fig. 9

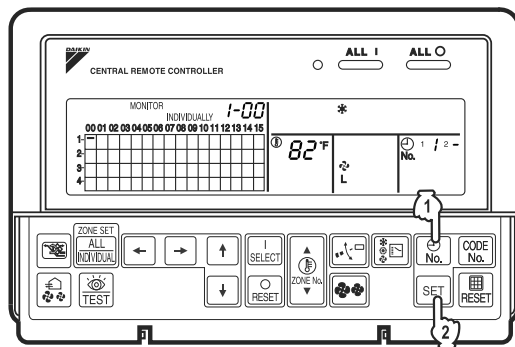

Fig. 10

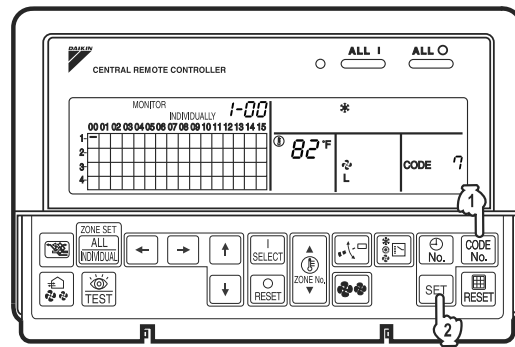

Fig. 11

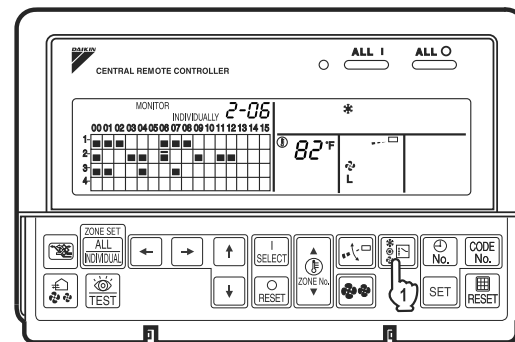

Fig. 12

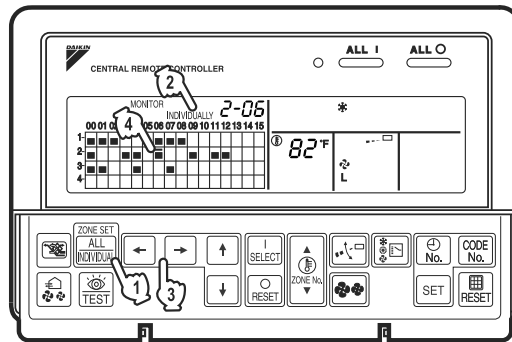

Fig. 13

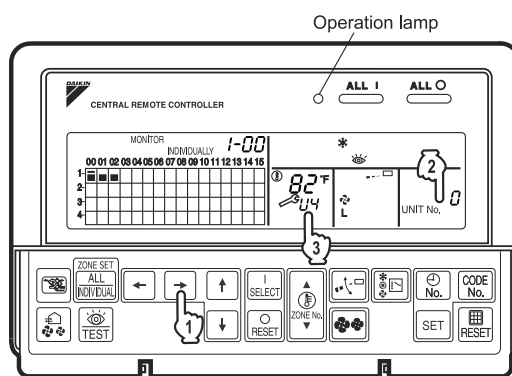

Fig. 14

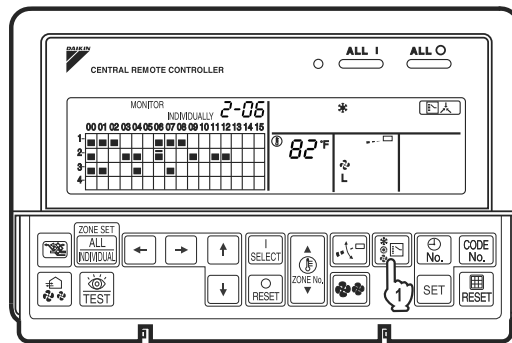

Fig. 15

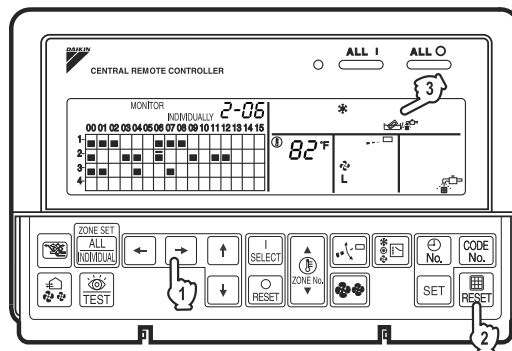

Fig. 16

2.9 <DCS301C71> Unified ON/OFF Controller (Installation)

Please read these SAFETY INSTRUCTIONS carefully before installation. Read and understand the label for each component. Follow the safety instructions for each component. Make sure you follow the safety instructions for each component. Do not touch the components until they are completely cooled down. Do not touch the components until they are completely cooled down. Do not touch the components until they are completely cooled down.

Always use the correct tools and techniques.

- WARNING**..... Indicates a potentially hazardous situation which, if not avoided, could result in death or serious injury.
- CAUTION**..... Indicates a potentially hazardous situation which, if not avoided, could result in minor or moderate injury or property damage.
- NOTE**..... Indicates important information about equipment or accessory damage prevention.

WARNING

- Ask your dealer or qualified personnel to carry out installation work. Do not try to install the machine by yourself.
- Perform installation work as described with this installation manual.
- Be sure to use only the specified accessories and parts for installed on work.
- Carry out the specified installation work after taking into account strong winds, typhoon or earthquake.
- Make sure that a separate power supply circuit is provided for the unit and that all electrical work is carried out by qualified personnel according to local laws and regulations.
- Make sure that all wiring is secured, the specified wire and used, and no external forces act on the terminal connections or wires.
- When wiring the power supply and connecting the remote control or opening and closing operation using gas from the supply so that the safety gas valve can be securely retained.
- Before touching electrical parts, turn off the unit.
- Ground the air conditioner. Do not connect the ground wire to gas or water pipes, lightning rod or a telephone ground wire.
- When installing or relocating the system, be sure to keep the refrigerant circuit free from substances other than the specified refrigerant (R410A) such as oil.
- Do not reinsert or change the settings of the protection device.
- Do not touch the switch with wet fingers.
- Keep the unit clean and dry.
- Do not install the air conditioner or the remote controller in the following locations:
 - In places where there is a risk of fire or explosion.
 - In places where there is a risk of falling objects or debris.
 - In places where there is a risk of water damage.
 - In places where there is a risk of vibration.
 - In places where there is a risk of strong winds or rain.
 - In places where there is a risk of lightning strikes.
 - In places where there is a risk of fire or explosion.
 - In places where there is a risk of falling objects or debris.
 - In places where there is a risk of water damage.
 - In places where there is a risk of vibration.
 - In places where there is a risk of strong winds or rain.
 - In places where there is a risk of lightning strikes.

CAUTION

- Be sure to use the correct product and components.
- Be sure to use the correct tools and techniques.
- Do not start the power immediately after stopping operation.

NOTE

- Install the indoor and outdoor unit power supply wiring and connecting wires at least 25h away from televisions or radios in order to prevent image interference or noise.
- Refrigerant should be filled in the correct amount.
- Do not use the power supply for other purposes.
- Do not use the power supply for other purposes.
- Do not use the power supply for other purposes.

1 COMPONENTS

Check the following components and their dimensions before installation.

304

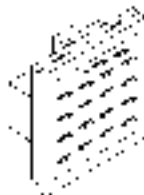

When using the optional accessories, an electrical panel for a KQ2126 computer terminal (like a standard desktop panel) has to be provided in the rack.

| | |
|-----------------------------|-----|
| Installation depth (mm) (1) | 304 |
| Depth of chassis | 1 |
| Panel dimensions | 4 |
| Panel layout (mm) | 3 |
| Panel layout (mm) | 1 |

2 SYSTEM CONFIGURATION

The status ON/OFF controls are divided into two groups: 1) controls for a maximum of 16 groups of indicators; 2) controls ON/OFF for indicator lights, divided into two sub-groups: a) controls for 16 groups of indicators.

● When using 16-bit ON/OFF controls:

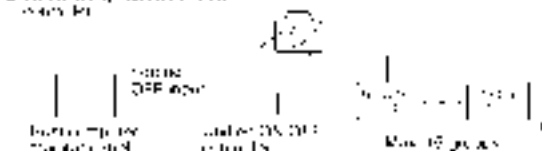

The value is necessary but it is not applicable with a multiplexed indicator apparatus connected to the panel.

In groups of users units, it is as follows:

1. One indicator unit (with 16 indicators)

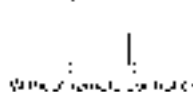

2. One indicator control unit or two indicator control units

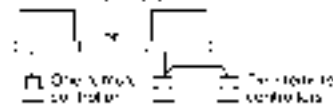

● When using 2-bit ON/OFF controls:

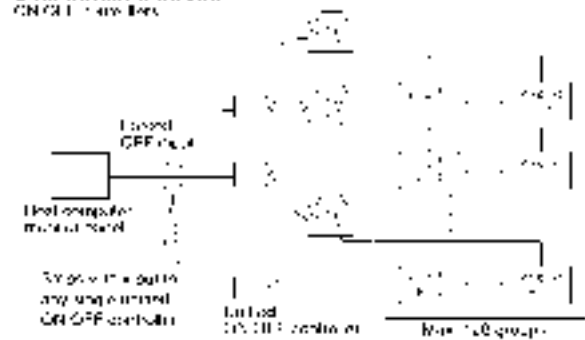

1. One computer terminal panel

2. One or more units (any number) ON/OFF controls

Control panel

Indicator lights

3. A maximum of 16 indicator units controlled in groups by one or two indicator controls

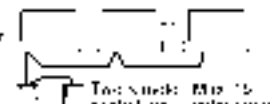
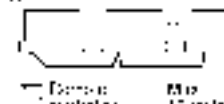

3 INSTALLATION

1. Open the upper part of control panel. From the upper part of the control panel, the screws between the upper part and the lower part of control panel and fasten the screws accordingly.

2. Insert the screws with nuts in upper and lower part of control panel. Do not forget to use washers in the upper part.

3. Open the upper part of control panel and fasten the screws accordingly. Do not forget to use washers in the upper part.

NOTE: Before beginning the installation, check the dimensions of the control panel and the dimensions of the control panel to be installed in the rack. The dimensions of the control panel are as follows:

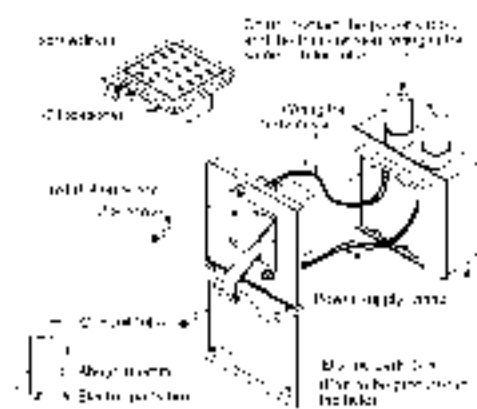

4 INITIAL SETTING

Setting **4** (Factory Default) is not valid when power is turned ON from the standby state. BEFORE adjusting the power

1. Do not touch setting knob on the (S)A. (Factory default is the state of factory set.)
2. When using Limited ON/OFF controller, do not touch the controller return marker (position of the set and with the release of the state of work). (Factory default.)
3. When using multiple-unit ON/OFF controller, do not operate the ON/OFF controller to complete the operation of the set. (The limited control knob setting is invalid in this case.)

| From the state of the set, controller knob is not locked, turn knob ON/OFF (press) as follows. | | | Controller knob with limited controller (S)A setting knob ON/OFF (press) as follows. | | |
|--|---------|---------------|--|------|---------|
| Factory | Factory | Release state | Factory | None | Factory |
| | | | | | |
| Factory | Factory | Factory | Factory | None | Factory |

NOTE: For instructions on how to set the set, refer to setting manual provided for the central remote controller. Also, the standard manual provided with the set contains the manual.

2. Search for setting room address (S)A. These switches are used to set the room address. Go to No. 1 (S)A on the upper 12 digits of the setting panel as follows, and a stopped state is set.

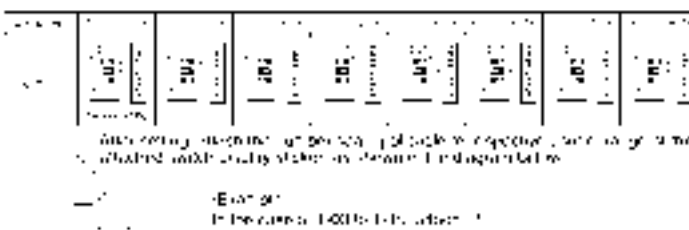

When setting is done, an address is displayed on the display. When the address is set, it is indicated with a red state on the main display panel.

Example: In the case of 10010101, address 1



3. MAIN SUD through the switch setting. Limited ON/OFF controller is connected to the main SUD through the switch. The limited ON/OFF controller is set to the MAIN SUD through the address of S)A.

4. Setting of the frequency operation keypad. The limited ON/OFF controller is equipped with the setting keypad. When the frequency operation keypad is set, the limited operation is supported. When the limited operation is supported, the limited operation is supported. (The limited operation is supported when the limited operation is supported.)

NOTE: The frequency operation keypad is supported when the limited operation is supported. The limited operation is supported when the limited operation is supported. The limited operation is supported when the limited operation is supported.

5. Control knob selector (S)A. The following four settings are set to the knob selector.

| State | When set | Controller | When set, the operation is performed by the controller | ON/OFF mode position (factory default) |
|---------|---|--|--|---|
| Control | Control knob selector (S)A is set to the ON/OFF mode (factory default). | When set, the ON/OFF controller is supported. When the ON/OFF controller is supported, the limited operation is supported. | When set, the operation is performed by the controller. When the operation is performed by the controller, the limited operation is supported. | Control knob selector (S)A is set to the ON/OFF mode (factory default). |
| Factory | | | | |

- NOTES: indicates the position of the knob. When the knob is set, the knob is set to the ON/OFF mode. When the knob is set, the knob is set to the ON/OFF mode.

6. Factory reset switch (S)A. When changing the setting of the controller, the setting manual provided with the set is used. When the setting manual is used, the setting manual is used. When the setting manual is used, the setting manual is used.



5 ELECTRIC WIRING

GENERAL INSTRUCTIONS

- All wiring should only be made by a qualified electrician familiar with the applicable local and national codes.
- Use copper wire, unless only.
- All electrical and components must be provided by licensed electrical.
- All shall be grounded in accordance with applicable local and national codes.
- All electrical supply wiring must be made at the switch.
- After wiring work, check power to the supply and turn OFF when switch is turned OFF.

WIRING OUTLINE

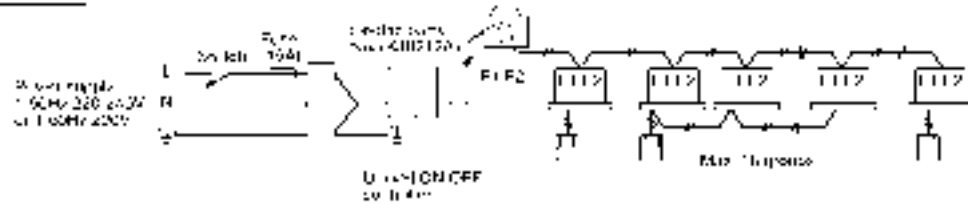

Wiring specification

| Wiring | Type | Size | NOTE |
|---------------------|--------------------------|------------------------------|--|
| Power supply wiring | Hardwired | 1.5mm ² (1.25mm) | 1. The wire or power supply wire must comply with the applicable national and local codes. 2. All wires, or other power supply, shall be 600V. Max. 1000m (plus wire length 5000m) |
| Control wiring | Standard (AV, VAV, VAVC) | 0.75mm ² (0.75mm) | |

Connect the wiring between indoor and outdoor units, indoor power units and power supply and power units and indoor control units. For details, refer to the installation manual of indoor and outdoor units.

WIRING TO THE INDOOR UNIT AND OUTDOOR UNIT

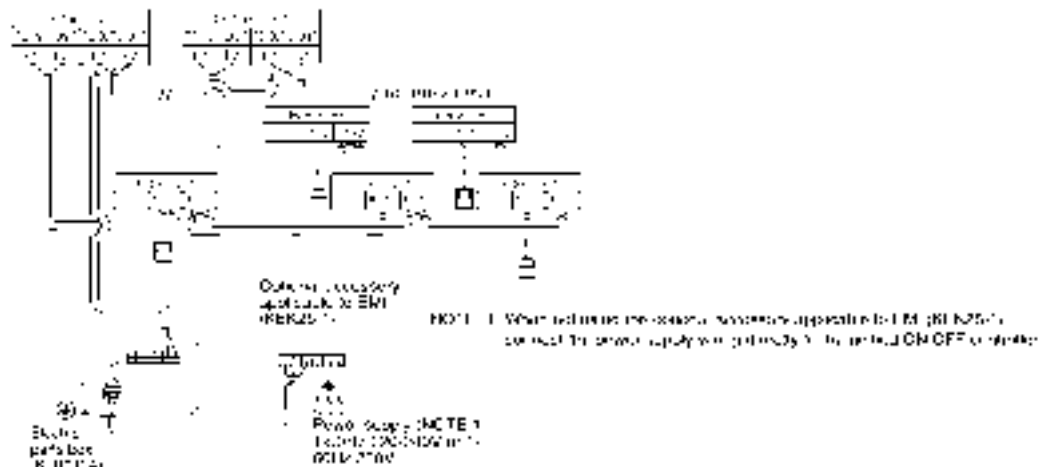

CONTROL TERMINAL STRIP

1. Turn power supply main and OFF (OFF).
2. Power OFF again (OFF).
- While the power OFF, plug the control terminal for indoor control in ON position in the control terminal strip and plug the control terminal for outdoor control in OFF position.
- Use only control terminal strip with the maximum applicable load: 100V/10mA.

NOTE: Use control terminal strip with a load of over 200mA and a wiring length of over 100m.

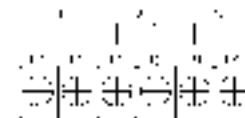

2. Plug the control terminal strip (T1, T2, T3, T4) into the control terminal strip (NOTE 1) and plug the control terminal strip into the control terminal strip (NOTE 2) and plug the control terminal strip into the control terminal strip (NOTE 3).

NOTE

Do not connect the power supply wiring (220V-240V) to the control terminal strip. It is provided by the manufacturer in many countries or countries and is optional. Units that are not listed in the manual may have a different wiring. Be sure to check with a local electrician before wiring.

6 SETTING GROUP NO. FOR CENTRALIZED CONTROL

Set the group number of each group of the device and set the remote controller in case of the need to be able to change the mode of the device. Use the group No. then, choose the correct operation.

1. Turn ON the power of the indoor unit and outdoor unit and the PS-DR controller (wait until the power ON mode of the unit is marked).
 Check the battery level of the remote controller and charge it before turning the power supply ON.
 When the power supply is turned ON, all LEDs operate once and the unit may be used after the operation for about one minute with the display of "Factory default: F0N (ON) or J0FF".
2. When the power mode is displayed as "Factory default: F0N (ON)",
 The remote controller will display the FIELD SET MODE.
3. Set the MODE No. (00) with the [] button.
 (The remote controller will display "00".)
4. Use the [] button to select the group No. for each group.
 Group numbers to be set are: 00 (00) → 10 (200) → 5 (5).
5. Press [] to turn the power supply ON.
6. Press [] to set the mode to NORMAL MODE.

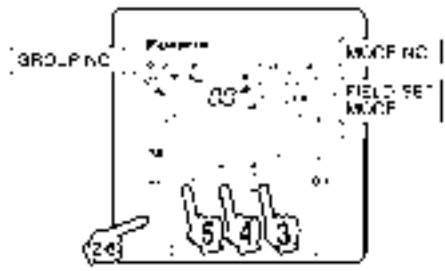

NOTES

- ▶ For enabled check points, see the remote control.
- ▶ For the first group No. (00) and group number for other air conditioners, check the remote control manual.

NOTE Enter the group No. and initialize power of the indoor unit and the outdoor unit after the task.
 Be sure to set the remote controller to the group No. and quit the remote page.

7 CONFIRMING OPERATION



Before starting the operation, stop power of the indoor and outdoor unit and the PS-DR controller and power to the PS-DR (BU-10) of the group setting system. To operate the device, turn the power of the group No. ON.

- NOTE**
- ▶ For the operation of the remote controller, refer to the installation manual (included article) and manual.
 - ▶ After turning the power supply ON of the unit, the normal operation for the remote controller is not included by default. Always check the battery level.
 - ▶ Check that setting of the remote controller setting is correct.
 - ▶ Check that the group No. for the remote controller has been set.

2.10 <DCS301C71> Unified ON/OFF Controller (Operation)

Please read these "SAFETY CONSIDERATIONS" carefully before installing air conditioning equipment and be sure to install it correctly. After completing the installation, make sure that the unit operates properly during the start-up operation.
 Please instruct the customer on how to operate the unit and keep it maintained.
 Also, inform customers that they should store this installation manual along with the operation manual for future reference.
 This air conditioner comes under the term "appliances not accessible to the general public"

Meaning of warning, caution and note symbols.

-  **WARNING** Indication a potentially hazardous situation which, if not avoided, could result in death or serious injury.
-  **CAUTION** Indication a potentially hazardous situation which, if not avoided, may result in minor or moderate injury. It may also be used to alert against unsafe practices.
-  **NOTE** Indication situation that may result in equipment or property-damage-only accidents.

Keep these warning sheets handy so that you can refer to them if needed.
 Also, if this equipment is transferred to a new user, make sure to hand over this operation manual to the new user.

WARNING

In order to avoid electric shock, fire or injury, or if you detect any abnormality such as smell of fire, turn off power and call your dealer for instructions.

Ask your dealer for installation of the air conditioner.
 Incomplete installation performed by yourself may result in a water leakage, electric shock, and fire.

Ask your dealer for improvement, repair, and maintenance.
 Incomplete improvement, repair, and maintenance may result in a water leakage, electric shock, and fire.

Improper installation or attachment of equipment or accessories could result in electric shock, short-circuit, leaks, fire or other damage to the equipment.
Be sure only to use accessories made by Daikin which are specifically designed for use with the equipment and have them installed by a professional.

Ask your dealer to move and reinstall the air conditioner or the remote controller.
 Incomplete installation may result in a water leakage, electric shock, and fire.

Never let the indoor unit or the remote controller get wet.
 It may cause an electric shock or a fire.

Never use flammable spray such as hair spray, lacquer or paint near the unit.
 It may cause a fire.

Never replace a fuse with that of wrong ampere ratings or other wires when a fuse blows out.
 Use of wire or copper wire may cause the unit to break down or cause a fire.

Never inspect or service the unit by yourself.
 Ask a qualified service person to perform this work.

Cut off all electric waves before maintenance.

Do not wash the air conditioner or the remote controller with excessive water.
 Electric shock or fire may result.

Do not install the air conditioner or the remote controller at any place where flammable gas may leak out.
 If the gas leaks out and stays around the air conditioner, a fire may break out.

Do not touch the switch with wet fingers.
 Touching a switch with wet fingers can cause electric shock.

CAUTION

After a long use, check the unit stand and fitting for damage.
 If they are left in a damaged condition, the unit may fall and result in injury.

Do not allow a child to mount on the unit or avoid placing any object on it.
 Falling or tumbling may result in injury.

Do not let children play on and around the unit.
 If they touch the unit carelessly, it may result in injury.

Do not place a flower vase and anything containing water.
 Water may enter the unit, causing an electric shock or fire.

Never touch the internal parts of the controller.
 Do not remove the front panel. Some parts inside are dangerous to touch, and a machine trouble may happen.
 For checking and adjusting the internal parts, contact your dealer.

Avoid placing the controller in a spot splashed with water.
 Water coming inside the machine may cause an electric leak or may damage the internal electronic parts.

Do not operate the air conditioner when using a room fumigation - type insecticide.
 Failure to observe could cause the chemicals to become deposited in the unit, which could endanger the health of those who are hypersensitive to chemicals.

Safely dispose of the packing materials.
 Packing materials, such as nails and other metal or wooden parts, may cause stabs or other injuries.
 Tear apart and throw away plastic packaging bags so that children will not play with them. If children play with a plastic bag which was not torn apart, they face the risk of suffocation.

Do not turn off the power immediately after stopping operation.
 Always wait at least five minutes before turning off the power. Otherwise, water leakage and trouble may occur.

The appliance is not intended for use by young children or infirm persons without supervision.

The remote controller should be installed in such away that children cannot play with it.

NOTE

Never press the button of the remote controller with a hard, pointed object.
 The remote controller may be damaged.

Never pull or twist the electric wire of the remote controller.
 It may cause the unit to malfunction.

Do not place the controller exposed to direct sunlight.
 The LCD display may get discolored, failing to display the data.

Do not wipe the controller operation panel with benzine, thinner, chemical dustcloth, etc.
 The panel may get discolored or the coating peeled off. If it is heavily dirty, soak a cloth in water-diluted neutral detergent, squeeze it well and wipe the panel clean. And wipe it with another dry cloth.

Dismantling of the unit, treatment of the refrigerant, oil and eventual other parts, should be done in accordance with the relevant local and national regulations.

1 NAMES AND FUNCTIONS

"UNDER HOST COMPUTER INTEGRATED CONTROL" LAMP
When this lamp turns on, no other operations are possible.

GROUP NO.

ROOM NAME INDICATION PLATE
Refer to the "2. PUTTING ROOM NAME INDICATION STICKER"

UNIFIED OPERATION/STOP BUTTON
Starts/stops all indoor units.

OPERATION LAMP
Turns on during operation of each group and flashes during malfunction stop.

INDIVIDUAL OPERATION/STOP BUTTON
Starts/stops each indoor unit group individually.

«NOTE»

- When using unified ON/OFF controller with other optional controllers for centralized control, "OPERATION LAMP" of the equipment which is not operated may turn on or off after several minutes. This state occurs due to signal communications and is not a failure.
- Do not open the upper part of remote controller except when rewriting the indication sticker or selecting control modes.

2 PUTTING ROOM NAME INDICATION STICKER

① Open the upper part of remote controller. Insert a (-) screwdriver into the recess between the upper and lower part of remote controller (at 2 locations) and twist the screwdriver lightly.

PC board is attached both the upper and lower part of remote controller. Do not damage the board with the screwdriver.

(-) screwdriver

(2 locations)

③ Put the attached indication sticker on the room name indication plate.

In case of serial type Indication sticker

In case of individual type Indication sticker

Indication plate

Put the sticker aligning the lines of the sticker with those of the plate.

Indication plate

Put the sticker on the center of the frame. Write the room name in the frame of the sticker with a ball point pen or a felt-tip pen (oil-base).

④ Reinstall the plate as it were, with checking the correct direction.

⑤ Close the upper part of remote controller.

② Pull out the room name indication plate. Insert the point of a mechanical pencil etc, into the hole of the indication sticker to pull it out.

Indication plate

Control mode selector (DS2)

3 SELECTING CONTROL MODES

The following four patterns of control mode can be set.

| Control mode | Individual | Centralized | Timer operation possible by remote controller | ON/OFF control impossible by remote controller |
|--------------|---|---|--|---|
| Content | Operation/stop is controlled by both unified ON/OFF controller and remote controller. | After operated by unified ON/OFF controller, operation/stop is freely controlled by remote controller until stopped by unified ON/OFF controller. | When used in conjunction with schedule timer, operation/stop is controlled freely by remote controller during the set time but operation is not available when schedule timer is ON. | Operation/stop is controlled by unified ON/OFF controller only. Indoor units can not be operated/ stopped by remote controller. |
| DS2 setting | | | | |

NOTE:

- indicates the position of switches.
- Set control modes before turning power supply on.
- When used in conjunction with central remote controller, the control modes of the central remote controller has the priority.

4 DISPLAY OF MALFUNCTION



Flashing of lamps indicates malfunctions. Contact your Daikin dealer. When turning power supply on, all lamps may light and UNDER HOST COMPUTER INTEGRATED CONTROL lamp may flash and not accept the operation for about on minute. These conditions are not malfunctions.

| States of lamps | Contents of malfunctions |
|---|--|
| Flashing of operation lamp | Indicates malfunctions in the indoor unit in the group where the operation lamp is flashing. |
| Flashing of UNDER HOST COMPUTER INTEGRATED CONTROL lamp | Indicates malfunctions in optional controllers for centralized control. |

2.11 <DST301BA61> Schedule Timer Controller (Installation)

Please read these "SAFETY CONSIDERATIONS" carefully before installing air conditioning equipment and be sure to install it correctly. After completing the installation, make sure that the unit operates properly during the start-up operation. Please instruct the customer on how to operate the unit and keep it maintained. Also, inform customers that they should store this installation manual along with the operation manual for future reference. This air conditioner comes under the term "appliances not accessible to the general public".

Meaning of warning, caution and note symbols.

-  **WARNING** Indication a potentially hazardous situation which, if not avoided, could result in death or serious injury.
-  **CAUTION** Indication a potentially hazardous situation which, if not avoided, may result in minor or moderate injury. It may also be used to alert against unsafe practices.
-  **NOTE** Indication situation that may result in equipment or property-damage-only accidents.

WARNING

Ask your dealer or qualified personnel to carry out installation work. Do not try to install the machine by yourself.
Improper installation may result in water leakage, electric shocks or fire.

Perform installation work in accordance with this installation manual.
Improper installation may result in water leakage, electric shocks or fire.

Be sure to use only the specified accessories and parts for installation work.
Failure to use the specified parts may result in water leakage, electric shocks, fire or the unit falling.

Carry out the specified installation work after taking into account strong winds, typhoons or earthquakes.
Improper installation work may result in the equipment falling and causing accidents.

Make sure that a separate power supply circuit is provided for this unit and that all electrical work is carried out by qualified personnel according to local laws and regulations and this installation manual.
An insufficient power supply capacity or improper electrical construction may lead to electric shocks or fire.

Make sure that all wiring is secured, the specified wires and used, and no external forces act on the terminal connections or wires.
Improper connections or installation may result in fire.

When wiring the power supply and connecting the remote controller wiring and transmission wiring, position the wires so that the electric parts box lid can be securely fastened.
Improper positioning of the electric parts box lid may result in electric shocks, fire or the terminals overheating.

Before touching electrical parts, turn off the unit.

Ground the air conditioner. Do not connect the ground wire to gas or water pipes, lightning rod or a telephone ground wire.
Incomplete grounding may result in electric shocks.

When installing or relocating the system, be sure to keep the refrigerant circuit free from substances other than the specified refrigerant (R410A), such as air.

Do not reconstruct or change the settings of the protection devices.
If the pressure switch, thermal switch, or other protection device is shorted and operated forcibly, or parts other than those specified by Daikin are used, fire or explosion may result.

Do not touch the switch with wet fingers.
Touching a switch with wet fingers can cause electric shock.

Install an earth leak circuit breaker, as required.
If an earth leak circuit breaker is not installed, electric shock may result.

Do not install the air conditioner or the remote controller in the following locations:

- (a) where a mineral oil mist or an oil spray or vapor is produced, for example in a kitchen
Plastic parts may deteriorate and fall off or result in water leakage.
- (b) where corrosive gas, such as sulfurous acid gas, is produced
Corroding copper pipes or soldered parts may result in refrigerant leakage.
- (c) near machinery emitting electromagnetic waves
Electromagnetic waves may disturb the operation of the control system and result in a malfunction of the equipment.
- (d) where flammable gases may leak, where there are carbon fiber or ignitable dust suspensions in the air, or where volatile flammables such as thinner or gasoline are handled
Operating the unit in such conditions may result in fire.

CISPR 22 Class A Warning.

This is a class A product. In a domestic environment this product may cause radio interference in which case the user may be required to take adequate measures.

 **CAUTION**

Be very careful about product transportation.

Safely dispose of the packing materials.

Packing materials, such as nails and other metal or wooden parts, may cause stabs or other injuries.

Tear apart and throw away plastic packaging bags so that children will not play with them. If children play with a plastic bag which was not torn apart, they face the risk of suffocation.

Do not turn off the power immediately after stopping operation.

Always wait at least five minutes before turning off the power. Otherwise, water leakage and trouble may occur.

 **NOTE**

Install the indoor and outdoor units, power supply wiring and connecting wires at least 3.5ft. away from televisions or radios in order to prevent image interference or noise.

(Depending on the radio waves, a distance of 3.5ft. may not be sufficient enough to eliminate the noise.)

Remote controller (wireless kit) transmitting distance can result shorter than expected in rooms with electronic fluorescent lamps. (inverter or rapid start types)

Install the indoor unit as far away from fluorescent lamps as possible.

This unit is a class A product.

In a domestic environment this product may cause radio interference in which case the user may be required to take adequate measures.

Dismantling of the unit, treatment of the refrigerant, oil and eventual other parts, should be done in accordance with the relevant local and national regulations.

1 ACCESSORIES

Check the following accessories are included in the kit before installation.

| | | | |
|----------------------|---|---|---|
| Body | 1 | Installation screws (M4 × 16) | 2 |
| Operation manual | 1 | Attached electric wire (for individual use) | 1 |
| Installation manual* | 4 | Crimp style terminal (for individual use) | 2 |

For installation, a electrical box to be embedded is necessary (part to be procured in the field/with covers).
 * DST301BA61 includes only one installation manual.

2 INSTALLATION AND INITIAL SETTING

1. Remove the upper part of the remote controller.

- Insert a (-) screwdriver (2 locations) into the recess between the upper part and the lower part of the remote controller and twist the screwdriver lightly.

(The PC board is attached with the upper part of the remote controller. Do not damage electric parts with a screwdriver, etc.)

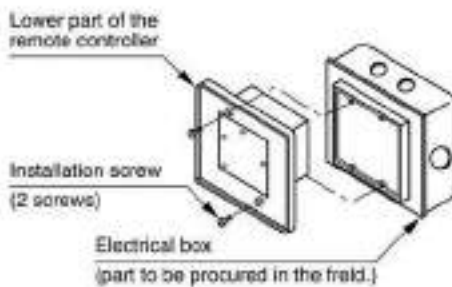
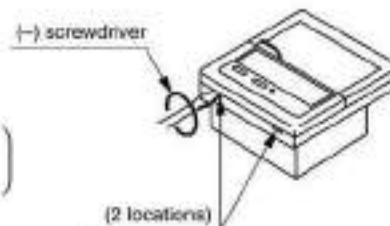

- Attach the lower part to the electrical box (part to be procured in the field) with the provided installation screws.

(Select a flat face as a installation place. Do not tighten the installation screws excessively not to damage the lower part of the remote controller.)

For part to be procured in the field electrical box, use KJB212AA (optional accessory).

2. Initial setting

- ① Setting connector for individual use (X1A) (Factory set : OFF) (Set for individual use only)

- For individual use of schedule timer
Insert the connector attached with the body case on the PC board.
- For combined use with other optional controllers for centralized control
Do not change the factory setting.

- ② Control mode selector (SS2) (Set for individual use only)

By changing the switch, setting mode of individual and centralized operation is available.

Note) When used with other optional controllers, control mode of central remote controller and unified ON/OFF controller have the priority.



- ③ Setting of the sequential operation function

The schedule timer is equipped with a sequential operation function that sequentially turns indoor units on in 2-second intervals during unified operation.

(Sequential operation is factory set to "ON.")

To switch sequential operation ON or OFF, set as follows.

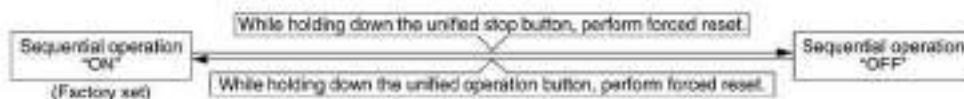

Note) The sequential operation function is designed to reduce the load on the power supply equipment, but does not guarantee that compressors will not be started simultaneously. You cannot therefore count on a capacity reduction effect by power supply equipment breaker selection.

- ④ **Forced reset switch (SS1)**
 When changing the setting of the connector for individual use, etc., the switch can be reset simply by setting it to the reset side once and returning to the normal side. This procedure enables to reset without turning off the power. (Set the normal side at normal operation.)

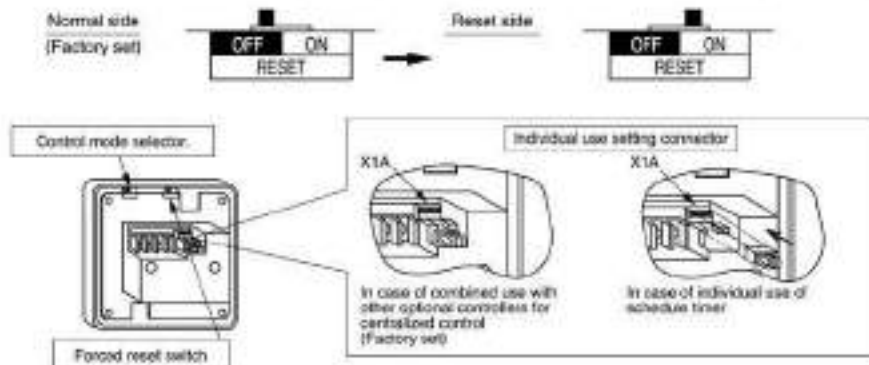

- ⑤ **Setting for special function**
 When you want to have a programmed operation of a part of indoor units by using only schedule timer, cut off JP1 and supply the power again. You can have a programmed operation of the indoor units set the address for central control by local remote controller.

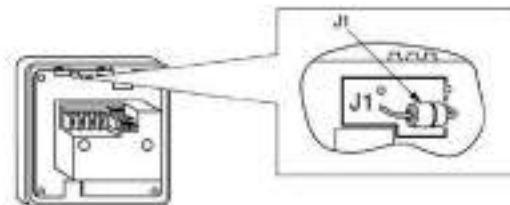

3. Transmission wiring

- In case of individual use of schedule timer**
 Connect terminals of the schedule timer (F1, F2) with terminals of the indoor unit (F1, F2). Connect terminals of the schedule timer (D1, D2) and the connector on the indoor unit PC board, using the attached electric wire and crimp style terminals. Prevent the connection part of crimp style terminal from getting out of the electric parts box of indoor unit.
- In case of combined use with other optional controllers for centralized control**
 Connect terminals of the schedule timer (F1, F2, D1, D2) and the terminals of the central remote controller (or unified ON/OFF controller).

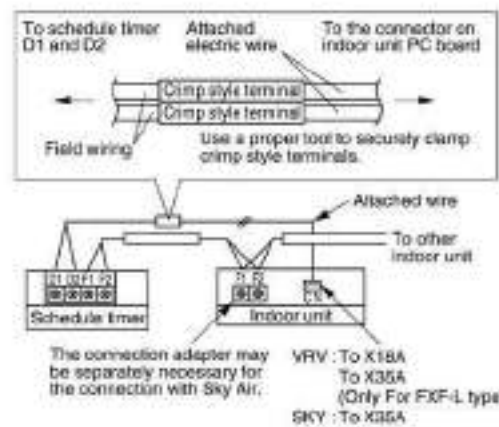

Wiring specifications

| | F1, F2 | D1, D2 |
|--------|----------------------------|----------------------------|
| Wiring | Sheathed wire (2-wire) | Sheathed wire (2-wire) |
| Gauge | 0.75 - 1.25mm ² | 0.75 - 1.25mm ² |
| Length | Max. 1000m | Max. 150m |

NOTES:

- Electrical box and transmission wiring are not attached.
- Do not touch the PC board with your hand.
- Keep transmission wiring at least 50 mm away from power supply wiring to avoid malfunctions.

- ④ **Install the upper part of the remote controller as before.**

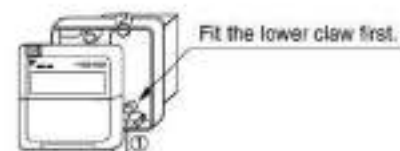

3 SETTING GROUP NO. FOR CENTRALIZED CONTROL

Set the group number of each group of the indoor unit from the remote controller. (In case of no remote controller, also connect the remote controller and set the group No. Then, remove the remote controller.)

- (1) Turn ON the power of the indoor unit and SCHEDULE TIMER.

(Unless the power is ON, no setting can be made.)

Check that the installation and electrical wiring are correct before turning the power supply ON.

(When the power supply is turned ON, all LCD appear once and the unit may not accept the operation for about one minute with the display of "88".)

- (2) While in the normal mode, hold down the " " button for a minimum of 4 seconds.

The remote controller will enter the FIELD SET MODE.

- (3) Select the MODE No. "00" with the " " button.

- (4) Use the " " button to select the group No. for each group.

(Group numbers increase in the order of 1-00, 1-01, ... 1-15, 2-00, ... 8-15.)

- (5) Press " " to set the selected group No.

- (6) Press " " to return to the NORMAL MODE.

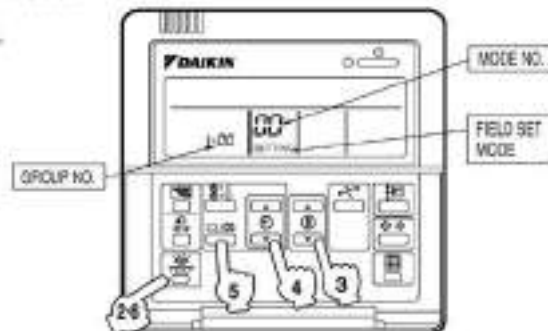

- NOTES)
- In case of individual use of schedule timer, Group number setting is not necessary. It is automatically set when turning power supply ON.
 - See the instruction manuals which came with the Ventlair and adapters (i.e., multi-purpose adapters) for details on their Group No. settings.

NOTICE Be sure to keep the operation manual for maintenance.

4 TEST OPERATION

Refer to the installation manual attached to the outdoor unit.

In case the schedule timer is used individually and the wiring is changed after the system has been operated, reset the power after energizing for more than five minutes. It may not be possible to control the unit from the schedule timer.

2.12 <DST301BA61> Schedule Timer Controller (Operation)

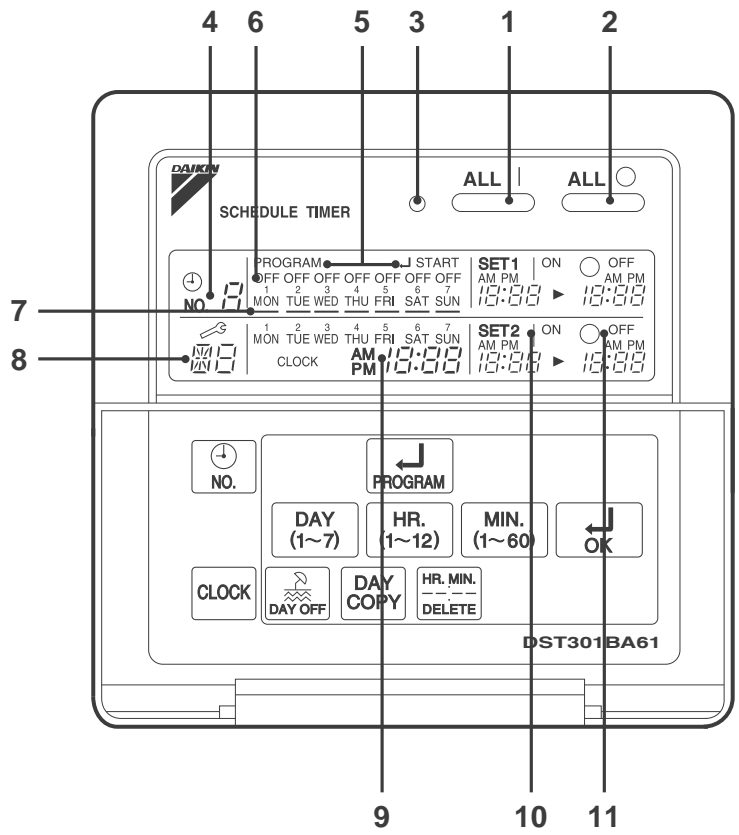

1

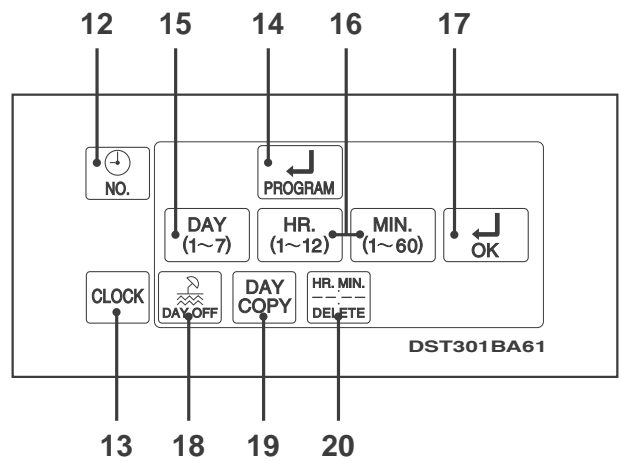

2

[1]

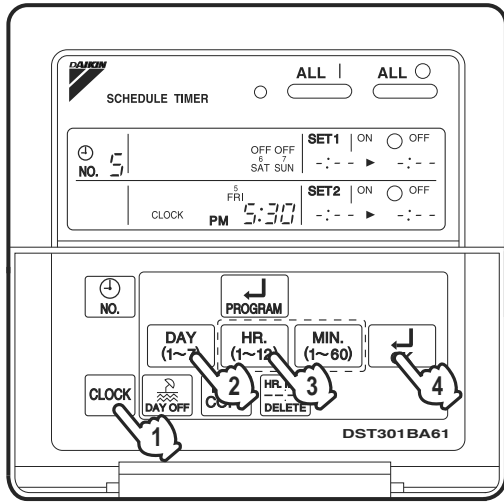

3

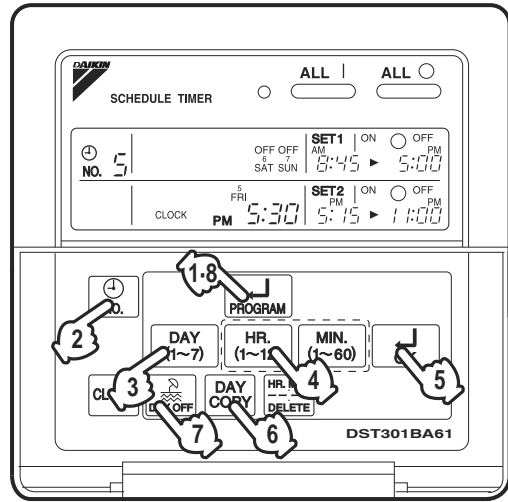

4

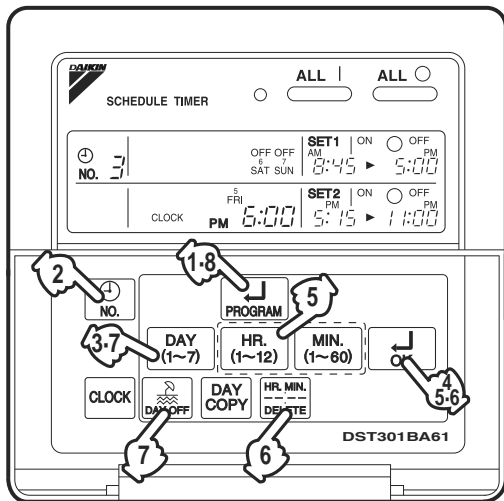

5

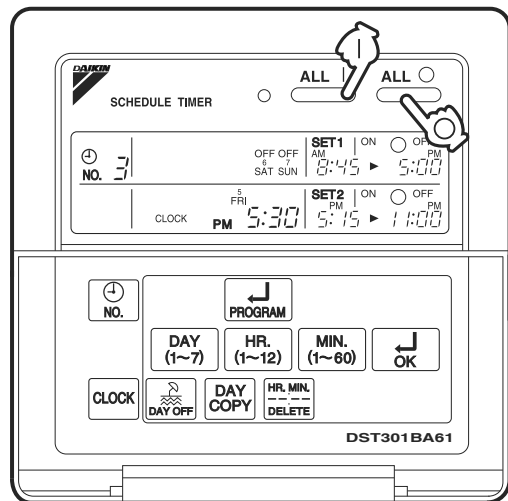

6

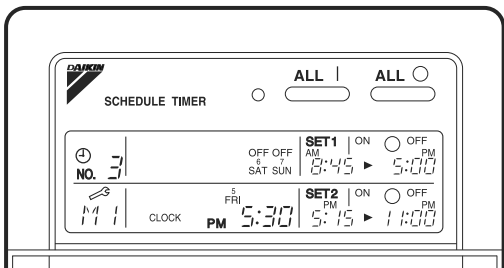

7

[2]

SAFETY CONSIDERATIONS

Please read these " SAFETY CONSIDERATIONS " carefully before installing air conditioning equipment and be sure to install it correctly. After completing the installation, make sure that the unit operates properly during the start-up operation.

Please instruct the customer on how to operate the unit and keep it maintained.

Also, inform customers that they should store this installation manual along with the operation manual for future reference.

This air conditioner comes under the term " appliances not accessible to the general public ".

Meaning of warning, caution and note symbols.

 **WARNING** Indicates a potentially hazardous situation which, if not avoided, could result in death or serious injury.

 **CAUTION** Indicates a potentially hazardous situation which, if not avoided, may result in minor or moderate injury. It may also be used to alert against unsafe practices.

 **NOTE** Indicates situation that may result in equipment or property-damage-only accidents.

Keep these warning sheets handy so that you can refer to them if needed.

Also, if this equipment is transferred to a new user, make sure to hand over this operation manual to the new user.

—  **WARNING** —

In order to avoid electric shock, fire or injury, or if you detect any abnormality such as smell of fire, turn off power and call your dealer for instructions.

Ask your dealer for installation of the air conditioner.

Incomplete installation performed by yourself may result in a water leakage, electric shock, and fire.

Ask your dealer for improvement, repair, and maintenance.

Incomplete improvement, repair, and maintenance may result in a water leakage, electric shock, and fire.

Improper installation or attachment of equipment or accessories could result in electric shock, short-circuit, leaks, fire or other damage to the equipment. Be sure only to use accessories made by Daikin which are specifically designed for use with the equipment and have them installed by a professional.

Ask your dealer to move and reinstall the air conditioner or the remote controller. Incomplete installation may result in a water leakage, electric shock, and fire.

Never let the indoor unit or the remote controller get wet.

It may cause an electric shock or a fire.

Never use flammable spray such as hair spray, lacquer or paint near the unit. It may cause a fire.

Never replace a fuse with that of wrong ampere ratings or other wires when a fuse blows out.

Use of wire or copper wire may cause the unit to break down or cause a fire.

Never inspect or service the unit by yourself.

Ask a qualified service person to perform this work.

Cut off all electric waves before maintenance.

Do not wash the air conditioner or the remote controller with excessive water. Electric shock or fire may result.

Do not install the air conditioner or the remote controller at any place where flammable gas may leak out.

If the gas leaks out and stays around the air conditioner, a fire may break out.

Do not touch the switch with wet fingers. Touching a switch with wet fingers can cause electric shock.

CISPR 22 Class A Warning:

This is a class A product. In a domestic environment this product may cause radio interference in which case the user may be required to take adequate measures.

⚠ CAUTION

After a long use, check the unit stand and fitting for damage.

If they are left in a damaged condition, the unit may fall and result in injury.

Do not allow a child to mount on the unit or avoid placing any object on it.

Falling or tumbling may result in injury.

Do not let children play on and around the unit.

If they touch the unit carelessly, it may result in injury.

Do not place a flower vase and anything containing water.

Water may enter the unit, causing an electric shock or fire.

Never touch the internal parts of the controller.

Do not remove the front panel. Some parts inside are dangerous to touch, and a machine trouble may happen.

For checking and adjusting the internal parts, contact your dealer.

Avoid placing the controller in a spot splashed with water.

Water coming inside the machine may cause an electric leak or may damage the internal electronic parts.

Do not operate the air conditioner when using a room fumigation - type insecticide.

Failure to observe could cause the chemicals to become deposited in the unit, which could endanger the health of those who are hypersensitive to chemicals.

Safely dispose of the packing materials.

Packing materials, such as nails and other metal or wooden parts, may cause stabs or other injuries.

Tear apart and throw away plastic packaging bags so that children will not play with them. If children play with a plastic bag which was not torn apart, they face the risk of suffocation.

Do not turn off the power immediately after stopping operation.

Always wait at least five minutes before turning off the power. Otherwise, water leakage and trouble may occur.

The appliance is not intended for use by young children or infirm persons without supervision.

The remote controller should be installed in such away that children cannot play with it.

⚠ NOTE

Never press the button of the remote controller with a hard, pointed object.

The remote controller may be damaged.

Never pull or twist the electric wire of the remote controller.

It may cause the unit to malfunction.

Do not place the controller exposed to direct sunlight.

The LCD display may get discolored, failing to display the data.

Do not wipe the controller operation panel with benzine, thinner, chemical dustcloth, etc.

The panel may get discolored or the coating peeled off. If it is heavily dirty, soak a cloth in water-diluted neutral detergent, squeeze it well and wipe the panel clean. And wipe it with another dry cloth.

Dismantling of the unit, treatment of the refrigerant, oil and eventual other parts, should be done in accordance with the relevant local and national regulations.

CONTENTS

| | |
|---|--|
| <p>SAFETY CONSIDERATIONS1</p> <p>FEATURES AND FUNCTIONS3</p> <p>NAMES AND FUNCTIONS OF OPERATING SECTION4</p> <p>OPERATION5</p> <p>Setting present time5</p> <p>Setting no. of programmed time6</p> | <p>Change and cancellation of no. of programmed time7</p> <p>Manual operation9</p> <p>Operation control code9</p> <p>Error diagnosing function9</p> <p>QUESTION AND ANSWER10</p> <p>SPECIFICATIONS12</p> <p>Specifications12</p> <p>Outline drawings12</p> |
|---|--|

FEATURES AND FUNCTIONS

■ **Operation controlled by programmed time**

Operating time and stopping time can be set to the minute by each day of the week. The operating and stopping patterns can also be set in schedule according to the time slot given twice a day in tune with the uses.



See page
5—9.

■ **Unified Operation/Stop**

By using this schedule timer, the unified operation/stop of the indoor unit can be executed manually regardless of the No. of programmed time in operation.







See page
9.

• **When used in conjunction with central remote controller (Optional Accessory)**

The operation controlled by programmed time can be set for up to eight different patterns (timer No. 1 – 8). Each schedule pattern can be also selected.

NAMES AND FUNCTIONS OF OPERATING SECTION (Fig. 1, 2)

| | | | | | |
|---|---|--|----|--|--|
| 1 | UNIFIED OPERATION BUTTON “ ALL ” | Press this button to perform the unified operation regardless of the No. of programmed time. | 9 | DISPLAY “ ¹ MON ² TUE ³ WED ⁴ THU ⁵ FRI ⁶ SAT ⁷ SUN ” CLOCK AM PM 10:00 ” | Displays the present day of the week and time. |
| | UNIFIED STOP BUTTON “ ALL ○ ” | | | Press this button to perform the unified stop regardless of the No. of programmed time. | |
| 3 | OPERATION LAMP (RED) | The light turns on during the operation of the indoor unit. | 11 | DISPLAY “ ○ OFF ” (PROGRAMMED TIME OF SYSTEM OFF) AM PM 10:00 | Displays the time programmed to stop. |
| | 4 | | | DISPLAY “ ⌚ NO. ” (TIME NO.) | |
| 5 | DISPLAY “PROGRAM ↵ START.” (PROGRAMMING START) | The light turns on when the timer is programmed. | 13 | CLOCK ADJUSTING BUTTON “ CLOCK ” | Press this button to set the present time. |
| | 6 | | | DISPLAY “ OFF ” (HOLIDAY SETTING) | |
| 7 | DISPLAY “ — ” (SETTING OF DAYS OF A WEEK) | Flashes below the day of the week programmed. | 15 | BUTTON FOR SELECTING DAYS OF A WEEK “ DAY (1~7) ” | Press this button to select the day of the week. |
| | 8 | | | DISPLAY “ ⚠ ” (MALFUNCTION CODE) | |

| | |
|---|---|
| 17 | TIMER ON BUTTON “  ” |
| | Press this button to set the present time and the programmed time. |
| 18 | HOLIDAY SETTING BUTTON “  ” |
| | Press this button to set holidays. |
| 19 | BUTTON FOR COPYING PROGRAM OF PREVIOUS DAY “  ” |
| | Use this button to set the No. of programmed time same as that of the previous day. |
| 20 | PROGRAM CANCELING BUTTON “  ” |
| | Use this button to set the programmed time to cancel. The display shows “-;--”. |
| <p>(Note)</p> <p>1. Please note that all the displays in the figure appear for explanation purpose or when the cover is open.</p> | |

OPERATION

■ Setting present time (Fig. 3)

(Example) In case of setting Friday, 5:30 p.m.

1.  Press the **CLOCK ADJUSTING BUTTON**. The present time display flashes.

(NOTE)

- The present time needs adjusting in case of turning power supply on for the first time or the occurrence of power failure over the period of 48 hours or more.

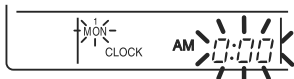

2.  Press the **BUTTON FOR SELECTING DAYS OF A WEEK**. Each time the button is pressed, the day display shifts to the right.

(NOTE)

- The display “ MON ” follows the display “ SUN. ”

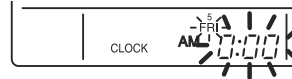

Set the day to Friday.

3.  Set the time with the **HOURLY/MINUTE BUTTON**. Each time the **HOURLY/MINUTE BUTTON** is pressed, the display is put forward minute by minute and hour by hour. When the button is kept pressed, the display is put forward continuously.

(NOTES)

- After becoming “ AM 11:00 ”, when the button is pressed, the display becomes “ PM 0:00 ”.
- After becoming “ 59 ” (minute), when the button is pressed, the display becomes “ 00 ” (minute).

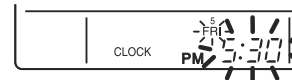

Set the time to 5:30 p.m.

4.  Press the **TIMER ON BUTTON** the moment the time signal of TV, radio, telephone, etc. is heard. The mark “ : ” flashes, and the clock starts.

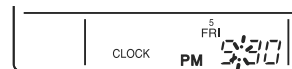

Press the **TIMER ON BUTTON** in tune with the time signal at 5:30 p.m.

(NOTES)

- The clock used is of 12-hour type.
- When you turn power supply on, the system may display “ 88 ” for about one minute and not start to operate after all the liquid crystal displays appear at a time.
- If the **CLOCK ADJUSTING BUTTON** is pressed by mistake, press it again to return to the original state. As the clock does not stop, the time indicated by the clock is kept correct. In case of power failure within 48 hours, the clock keeps operating by utilizing the built-in battery.

■ Setting no. of programmed time (Fig. 4)

(Example) Time No. 5 (to be programmed only when used in conjunction with the central remote controller)

Monday to Friday:

Operating from 8:45 a.m. till 5:00 p.m.
Operating from 5:15 p.m. till 11:00 p.m.

Saturday and Sunday:

Setting the whole day stop operation (application for holidays) controlled by programmed time.

1. Press the PROGRAMMING START BUTTON. Programming is available. The display “PROGRAM ↵ START” appears, and the display of days of a week flashes.



2. Press the TIME No. BUTTON, and select the desired number.

(NOTE)

- Unless used in conjunction with the central remote controller, The TIME No. is not displayed and can not be selected.

Select the TIME No. 5.

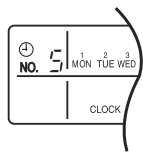

3. Press the BUTTON FOR SELECTING DAYS OF A WEEK, and set the proper day of the week. Each time you press it, the flashing display of days of a week shifts to the right.



Set to Monday.

(1) Setting programmed time

4. Set the programmed time of system start 1 by using the HOUR/MINUTE BUTTON. Each time the HOUR/MINUTE BUTTON is pressed, the display is put forward minute by minute and hour by hour. When the button is kept pressed, the display is put forward continuously.

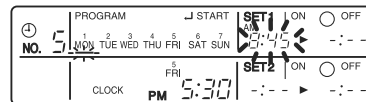

Set the “PROGRAMMED TIME OF SYSTEM START 1” at 8:45 a.m.

5. Press the TIMER ON BUTTON, and set the programmed time of system start 1. Each time you press it, the next area to be set flashes.

(NOTE)

- Set the other programmed time in the same procedure.

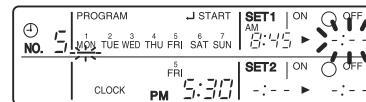

- (2) **Set the next day of the week.**
Set the day of the week to Tuesday, and copy the program of the previous day (Monday). In the same procedure, set the day of the week to Wednesday through Friday in sequence.

- 6. **Press the BUTTON FOR SELECTING DAYS OF A WEEK and set the following day. Press the BUTTON FOR COPYING PROGRAM OF PREVIOUS DAY. The same program as that of the immediately preceding day of the week is set.**

(NOTE)

- Repeat each procedure 3 – 5 in the above when not copying the contents of the previous day.

(3) **Holiday setting**

- 7. **Press the BUTTON FOR SELECTING DAYS OF A WEEK and set one or more days of the week as holiday. Press the HOLIDAY SETTING BUTTON, and the display “ OFF ” is displayed at the top of the day of the week. If you press it again, the display returns to the original state.**

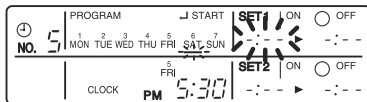

Set Saturday and Sunday as holidays.

- 8. **Press the PROGRAMMING START BUTTON, and finish the program setting.**

(NOTES)

- Unless the button is pressed within 20 minutes, the display will automatically revert back to the original state. In this case, setting contents up to the point where the TIMER ON BUTTON (or HOLIDAY SETTING BUTTON or BUTTON FOR COPYING PROGRAM OF PREVIOUS DAY) is pressed will only take effect.
- The display “ PROGRAM ↵ START ” and the display of days of a week “ — ” disappears.

- The flashing display goes off, and the No. of programmed time of the present day is displayed. Then the operation controlled by timer starts.
- The operation controlled by timer is executed even while the program is being set.



This is the end of the setting example.

■ **Change and cancellation of no. of programmed time (Fig. 5)**

(Example) **Time No. 3 (to be set only when used in conjunction with the central remote controller)**

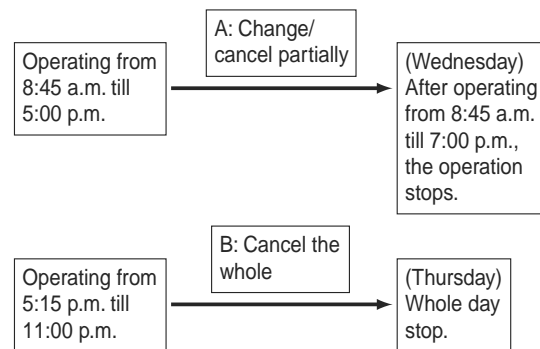

- Press the PROGRAMMING START BUTTON. The program setting is ready. The display “ PROGRAM ↵ START ” appears, and the display of days of a week flashes.**
- Press the TIME No. BUTTON, and select the desired No.**



Select the time No. 3.

3.  Press the **BUTTON FOR SELECTING DAYS OF A WEEK**, and set the day of the week to be changed. The set No. of programmed time of the day of the week is displayed.

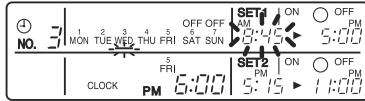

Set the day to Wednesday.

A. Change/cancel partially

4.  Press the **TIMER ON BUTTON** and change, and the display of programmed time flashes. Each time you press it, the next area to be set flashes.



Shift to the display "PROGRAMMED TIME OF SYSTEM OFF 1".

5.  Press the **HOUR/MINUTE BUTTON** and change the programmed time. Press the **TIMER ON BUTTON**, and finalize the setting of change.

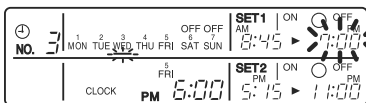

Change the "PROGRAMMED TIME OF SYSTEM OFF 1" to 7:00 p.m.

6.  Press the **PROGRAM CANCELING BUTTON**, and cancel the programmed time. If you press it again, display returns to the original state. Press the **TIMER ON BUTTON** to finalize the cancellation.

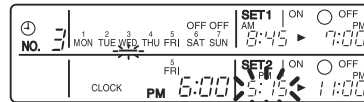

Shift to the "PROGRAMMED TIME OF SYSTEM START 2".

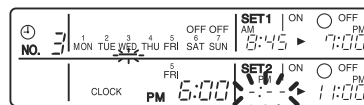

Set the "PROGRAMMED TIME OF SYSTEM START 2" to program cancellation.

In the same procedure, cancel the programmed time of system off 2.

B. Cancel the whole

7.  Press the **BUTTON FOR SELECTING DAYS OF A WEEK**, and shift to the day of the week to be canceled. Then, press the **HOLIDAY SETTING BUTTON**, the display "OFF" appears at the top of the particular day of the week. The programmed time is canceled. If you press the button again, the display returns to the original state.

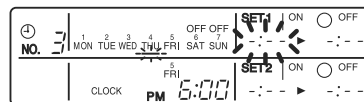

Shift the day of the week to Thursday to set as a holiday.



8.  Press the PROGRAMMING START BUTTON. The program setting is now finished.

(NOTES)

- Unless the button is pressed within 20 minutes, the display will automatically revert back to the original state. In this case, setting contents to the point where the **TIMER ON BUTTON** (or **HOLIDAY SETTING BUTTON** or **BUTTON FOR COPYING PROGRAM OF PREVIOUS DAY**) is pressed will only take effect.
- To continue the change/cancellation, do not press the **PROGRAMMING START BUTTON** until all change/cancellation are completed.
- The operation controlled by timer is executed even while the program is being set.

■ Manual operation (Fig. 6)

This schedule timer enables the operation/stop by pressing the **UNIFIED OPERATION/STOP BUTTON** in addition to the operation controlled by timer (operation/stop according to the programmed time) at any time.

- 1.  Press the UNIFIED OPERATION BUTTON, and the OPERATION LAMP turns on.**
- 2.  Press the UNIFIED STOP BUTTON, and the OPERATION LAMP is turned off.**

(NOTES)

- The operation automatically stops according to the programmed time of system off even during the manual operation. In the meantime, the operation starts automatically according to the programmed time of system start even during the stop of operation.
- If the unit is used in conjunction with other optional controllers for centralized control, the **OPERATION LAMP** of the unit that is not under operation control may be turned on or off a few minutes behind schedule. This shows that the signal is being exchanged, and does not indicate any failure.

| Operation lamp | |
|----------------------------------|---|
| <input type="radio"/> | Turn on: The light turns on when any of the indoor units is in operation whether the operation is controlled by timer or by hand. |
| <input checked="" type="radio"/> | Turn off: The light turns off when all the indoor units stop. |

■ Operation control code

Two different types of operation control codes can be selected when this kit is used independently (when not used in conjunction with the central remote controller, unified ON/OFF controller, etc.).

Individual

In case where the operation/stop is controlled by both schedule timer and remote controller.

Centralized

The operation is controlled by the schedule timer alone, and the operation/stop is controlled freely with the remote controller during the programmed time.

(NOTES)

- For current settings, contact your DAIKIN dealer.
- To change settings, contact your DAIKIN dealer.
Do not change settings yourself.

■ Error diagnosing function (Fig. 7)

This schedule timer is provided with the malfunction diagnosing function. The malfunction code flashes if there occurs any malfunction in communication, etc. between and among the optional controllers for centralized control. In addition, the operation lamp also flashes if there occurs any malfunction in communication with the indoor unit. Check the contents of the display and contact your DAIKIN dealer because the signals give you the idea of the trouble area.

| Operation lamp | Malfunction code | Contents of malfunction |
|----------------|------------------|--|
| Turn off | M1 | Failure of PC board of schedule timer. Fixes The following causes are possible. Check each one. 1. PC board problems |
| Turn on or off | M8 | Malfunction of transmission between each optional controllers for centralized control. Fixes Check all central devices which are connected (e.g., power supply, transmission wiring, etc.). |
| Turn on or off | MA | Improper combination of optional controllers for centralized control. Fixes The following causes are possible. Check each one. 1. Are all central devices combined correctly? 2. Is the master central connector attached to two or more central devices? 3. Are there 128 or more indoor units connected? |

| | | |
|----------------|----|---|
| Turn on or off | MC | Address failure of schedule timer. Fixes The following causes are possible. Check each one. 1. Do the control range addresses in the central remote controller overlap? 2. Do the control range addresses in the on/off controller overlap? 3. Are there 2 or more schedule timers connected? |
| Flash | UE | Malfunction of transmission between indoor unit and optional controllers for centralized control. Fixes Inspect all indoor units which are displaying an error (e.g., power supply, transmission wiring, etc.). |
| Flash | — | Malfunction in indoor unit (Refer to the malfunction codes of the indoor remote controller, while also read the "CAUTION FOR SERVICING" attached to the indoor unit.) |

QUESTION AND ANSWER

| Question | Answer |
|---|--|
| It is possible to make settings twice a day, but is it possible to make only the "off" setting? (To avoid forgetting to turn the unit off.) | Yes. Press the PROGRAM CANCELING BUTTON in the " ^{AM/PM} 12:00 ^{ON} " section in order to set it to "OFF". |

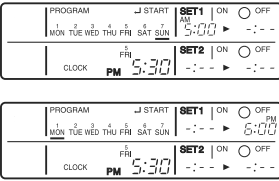
| | |
|---|---|
| <p>Is it possible to set times which straddle days?</p> | <p>Yes, it is possible. Example: Start operation at 5:00 a.m. on Sunday Stop operation at 6:00 p.m. on Monday</p>  |
| <p>The unit does not turn on even though the set "on" time has come. (When using the schedule timer alone)</p> | <p>The following causes are possible. 1. Are the "on" time and the "off" time set to the same time?</p> |
| <p>The unit does not turn on even though the set "on" time has come. (When using the unit with a central remote controller)</p> | <p>The following causes are possible. Check each one. 1. Was the timer number set with the central remote controller? Was an incorrect timer number set? 2. Is another timer no. set with the central remote controller set for "off" at the same time? 3. Is the operation code set to "remote control permission timer" using the central remote controller or the on/off controller?</p> |
| <p>The unit operates even though that day is set as a holiday. (When using the unit with a central remote controller)</p> | <p>The following causes are possible. 1. Is another timer number set with the central remote controller set for "on" at the same time? (If two timer numbers are set, make sure that the settings for holidays and working days do not overlap between the different timer numbers.)</p> |

| | |
|---|---|
| <p>The TIME NO. is not displayed.</p> | <p>The following causes are possible. 1. The TIME NO. is not displayed when using the schedule timer alone. (It can be set if using the central remote controller at the same time.)</p> |
| <p>The display remains</p>  <p>even though I push the HOUR/MINUTE BUTTON in the timer program settings.</p> | <p>The following causes are possible. 1. Is the day set to a holiday?</p> |
| <p>I cannot set "central management priority" or "after-push priority" with the schedule timer.</p> | <p>The following causes are possible. 1. Is a central remote controller or on/off controller also installed? * The priority order of the operation codes depends on the central devices which are installed. The below operation codes are set. • Schedule timer Central remote controller is used as well Operation code of the central remote controller • Schedule timer On/off controller is used as well Operation code of the on/off controller • Schedule timer Central remote controller On/off controller is used as well Operation code of the central remote controller</p> |

2.13 <KRP928BB2S> Interface Adaptor for DIII-NET

Safety Precautions

- Read these Safety Precautions carefully to ensure correct installation. This manual classifies precautions into WARNING and CAUTION.

WARNING : Failure to follow WARNING is very likely to result in such grave consequences as death or serious injury.

CAUTION : Failure to follow CAUTION may result in serious injury or property damage, and in certain circumstances, may result in a grave consequence.

Be sure to follow all the precautions below ; they are all important for ensuring safety.

WARNING

- Installation should be left to the dealer or another qualified professional.**
Improper installation by yourself may cause malfunction, electrical shock, or fire.
- Install the set according to the instructions given in this manual.**
Incomplete or improper installation may cause malfunction, electrical shock, or fire.
- Be sure to use the standard attachments or the genuine parts.**
Use of other parts may cause malfunction, electrical shock, or fire.
- Disconnect power to the connected equipment before starting installation.**
Failure to do so may cause malfunction, electrical shock, or fire.
- A ground fault circuit interrupter / an earth leakage circuit breaker should be installed.**
If the breaker is not installed, electrical shock may occur.

CAUTION

- Do not install the set in a location where there is danger of exposure to inflammable gas.**
Gas accumulated around the unit at the worst may cause fire.
- To prevent damage due to electrostatic discharge, touch your hand to a nearby metal object (doorknob, aluminum sash, etc.) to discharge static electricity from your body before touching this kit.**
Static electricity can damage this kit.
- Lay this cable separately from other power cables to avoid external electrical noises.**
- After installation is complete, test the operation of the PCB set to check for problems, and explain how to use the set to the end-user.

1. Overview, Features and Compatible Models

This kit is the interface required when connecting the central controller and a Room Air Conditioner. Use of the central controller makes it possible to perform the following monitoring and operations. It is compatible with room air conditioners which have an HA connector S21.

- Run / stop for the central controller and wired remote controller, operating mode selection, and temperature can be set.
- The operating status, any errors, and the content of those errors can be monitored from the central controller and wired remote controller.
- Run / stop for the central controller and wireless remote controller, operating mode selection, and the temperature setting can be limited by the central controller.
- Zone control can be performed from the central controller.
- The unit can remember the operating status of the air conditioner before a power outage and then start operating in the same status when the power comes back on.
- Card keys, operating control panels, and other constant / instantaneous connection-compatible equipment can be connected.
- The Operating / error signals can be read.
- The indoor temperature can be monitored from the iTM / iTC.

Precaution

- When reading the Operating / error signals, a separate external power source (12 V DC) is needed.
- A separate timer power source (16 V DC) is needed when using the schedule timer independently, and not in conjunction with other central controllers.
- The range of temperatures that can be set from the central controller is 18°C to 32°C in cooling and 14°C to 28°C in heating.
- Fan operation cannot be selected from the central controller or wired remote controller.
- Group control (i.e., control of multiple indoor units with a single remote controller) is not available.
- Monitoring is not available of the thermo status, compressor operating status, indoor fan operating status, electric heater, or humidifier operating status.
- Forced thermo off, filter sign display and reset, fan direction and speed settings, air conditioning fee management, energy savings instructions, low-noise instructions, and demand instructions cannot be made.
- Since a stop due to a momentary power failure cannot be detected, automatic operating start may not be possible.

2. Component Parts

This kit includes the following components. Check to ensure that none of these are missing.

| Parts | Q'ty | Parts | Q'ty |
|---|------|---------------------------------|------|
| Kit assy | 1 | Connection harness (about 1.8m) | 1 |
| PCB is in the housing. | | Mounting screws | 3 |
|  | | Binding band | 6 |
| | | Installation manual | 2 |
| | | Seal | 2 |
| | | | |

3. Names of Parts and Electric Wiring

<Wiring procedure>

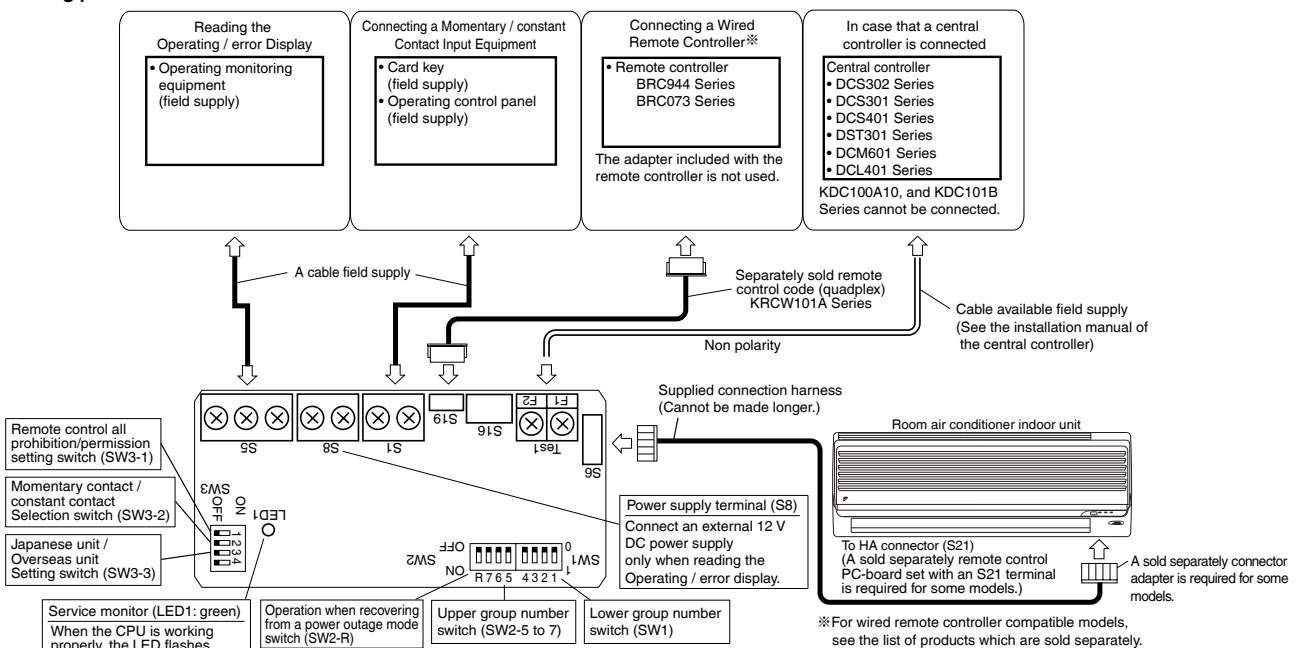

4. Switch Settings

NOTE Turn the power on after all the switches have been set. Settings made while the power is on are invalid.

Open the Kit's case and set the switches on the circuit board.
 (1) For Overseas / Japanese unit setting (SW3-3)
 Room air conditioners, different methods are used for setting the temperature in automatic mode, so this switch needs to be set.

| Destination | SW3-3 setting | What Happens |
|-------------|-----------------------|--|
| Japan | OFF (Factory setting) | • "Automatic" operation is not available from the central controller. When using "automatic" operation using the wireless remote controller, the central controller displays automatic cooling (heating) and 25°C. Even if the temperature is changed, it will return to 25°C after a while. |
| Overseas | ON | • "Automatic" operation is available from the central controller. |

(2) Group number settings (SW1 and SW2-5 to SW2-7)
 Set these when using the central controller. (Set to the side.) Do not set more than one unit to the same number.
 Use SW2-R for (3) Settings when recovering from a power outage.

However, these settings do not need to be made when using the schedule timer independently.
 (The settings are needed when used in conjunction with another DCS Series central controller.)
 In this case, the schedule timer performs an auto address after the power is turned on, so new group numbers are automatically set. Settings made using the switches will be overwritten.

Group NO. Settings table (Enlarged section SW1 and SW2 in "3. Names of Parts and Electrical Wiring")

| Group NO. Upper settings SW2 | | Group NO. Lower settings SW1 | | | | | |
|------------------------------|----|------------------------------|-----|-----|-----|--|--|
| 1- | 5- | 00- | 04- | 08- | 12- | | |
| 2- | 6- | 01- | 05- | 09- | 13- | | |
| 3- | 7- | 02- | 06- | 10- | 14- | | |
| 4- | 8- | 03- | 07- | 11- | 15- | | |

: Use with power failure recovery settings Set to the side : ON : OFF

NOTE also that a separate timer power source is needed when using the schedule timer independently.
 Power source specs: 16 V DC, +10%, -15%, 200mA.

(3) Settings when recovering from a power outage (SW2-R)
 This selects whether to restart operation when the power comes back on after a power outage occurred during operation. This setting is given priority in cases where the indoor unit has an auto start ON / OFF jumper. Note also that regardless of whether switch SW2-R is on or off, the operating mode (NOTE), set temperature, fan direction and speed settings, and remote control prohibition status are stored.

| SW2-R setting | What Happens |
|-----------------------|---|
| OFF (Factory setting) | Stops after recovering from a power outage |
| ON | Stops if the unit was stopped before the power outage and runs if it was running. |

(NOTE) The following settings apply to the models below.

| Room air conditioner | Mode before the power outage | |
|--|------------------------------|---------------|
| | COOLING | HEATING |
| Models with humid heating and dehumidifying functions. | DRY COOLING | HUMID HEATING |
| Models with dehumidifying function. | | HEATING |

(4) Contact input function settings (SW3-1 to SW3-2)
 When using contact input (S1), choose one of the following functions.

| S1 operating mode | SW3-1 setting | SW3-2 setting | What Happens | Control mode |
|---|---------------|---------------|--|---|
| Instantaneous contact input (factory setting) | OFF | OFF | The operating status of the air conditioner is reversed by an instantaneous input of 100 msec or more. | Last command priority |
| | | ON | Contact - Open to close: air condition runs. Close to open: air conditioner is stopped (NOTE 1). | ON / OFF control is rejected (operate / stop / timer prohibition) (NOTE 2). |
| Remote control all prohibition/permission input | ON | Invalid | Contact - Open to close: air condition stops. Close to open: no change in operating status. | All remote controller actions are prohibited when the contact is closed. (NOTE 3) |

NOTE1: Since central controller uses last command priority, the contact status and operating status of the air conditioner might not match sometimes.
 Example: If the unit is run from the central controller while the air conditioner is stopped with an open contact, the contact will be open and the unit will be running.
NOTE2: Operating mode and fan direction and speed settings can be changed.
NOTE3: If the contact is closed while the ON timer is set, as the power ON timer function is still operating, the operation starts at the time specified by the timer. To prevent operation of the power ON timer, use of the (KRP413BB1S) remote control PC-board set is recommended. However, note that it cannot be used in tandem with the central controller.
 If this product is connected to an air conditioner manufactured in or after 2011, when the contact is closed, the power ON timer may be cancelled depending on the combination with the model.

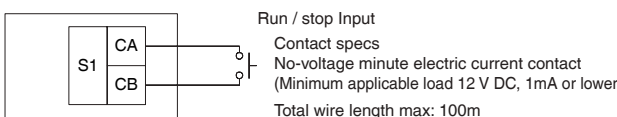

5. Control Codes

When using a central remote controller, the operating codes can be used to limit operation from wireless remote controllers. Three beeps for signal reception will be heard continuously when the wireless remote controller is operated while in central control.
 ○ : permitted; × : prohibited

| S1 operating mode | Control mode | Control code | Operations from the remote controller | | | | | | | | | |
|--|--|----------------------|---|------|----------------------------|--|-------------|------|----------------------------|-----------------------------|--|----|
| | | | "Run" control from the central controller | | | "Stop" control from the central controller | | | | | | |
| | | | Run / timer | Stop | Operating mode temperature | Fan direction and fan speed | Run / timer | Stop | Operating mode temperature | Fan direction and fan speed | Operations from central controller and contact input | |
| Instantaneous contact mode | ON / OFF control is rejected | 0,1,3 10,11 | × | × | × | × | × | × | × | × | | |
| | Only OFF control is accepted | 2 12-19 | × | × | × | × | × | × | × | × | | |
| | Central priority | 4 5 | ○ | ○ | ○ | ○ | × | ○ | × | × | | |
| | Last command priority | 6,7 | ○ | ○ | ○ | ○ | ○ | ○ | ○ | ○ | | |
| | Timer operation is accepted by remote controller | 8 9 | ○* | ○* | ○* | ○ | × | × | × | × | ○ | |
| Constant contact mode | | 2,10-19 0,1,3,5-7 | | × | × | × | | | | | × | |
| | | 4 | × | × | × | × | × | × | × | × | | |
| | | 8 | | | | | | | | | | × |
| | | 9 | | | | | | | | | | ○* |
| All remote controller actions are prohibited | | | × | × | × | × | × | × | × | × | | |

*Only during timer operation
 The remote controller permission / prohibition settings using the ITM / ITC are as follows.
 ○ : permitted; × : prohibited

| S1 pin operating mode | ITM / ITC settings | | | Operations from the remote controller | | | Operations from central controller and contact input |
|---|------------------------------|-----------------------|------------------------|---------------------------------------|------|----------------------------|--|
| | Start / stop | Change operating mode | Change set temperature | Run / timer | Stop | Operating mode temperature | |
| Instantaneous contact mode • Constant contact mode | ON / OFF control is rejected | permitted | permitted/prohibited | × | × | ○ | |
| | Only OFF control is accepted | permitted | permitted/prohibited | × | × | ○ | |
| Constant contact mode | Last command priority | permitted | permitted/prohibited | × | × | ○ | ○ |
| | | prohibited | permitted/prohibited | × | × | × | |
| Instantaneous contact mode • Constant contact mode | Last command priority | permitted | permitted/prohibited | ○ | ○ | ○ | |
| | | prohibited | permitted/prohibited | × | × | × | |
| All remote controller actions are prohibited | Does not affect settings | | | × | × | × | × |

6. Read Operating / Error Display Signal

The Operating / error signals can be read from the contact output (S5).
Output specs
 M1: Turn MR 1 ON when the air conditioner is running.
 M2: Turn MR 2 when a communication error has occurred between the KRP928BB2S and the air conditioner, or MR 1 is ON and the unit has stopped after an error.
 MR 2 is not turned ON during a warning.

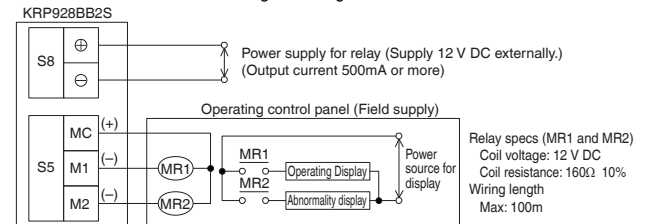

7. Combining Equipment

The central controller can be combined with the following devices.

| | Central Remote Controller | ON / OFF controller | Schedule timer | D-BIPS | Contact input | Wired Remote Controller | Wireless Remote Controller |
|----------------------------|---------------------------|---------------------|----------------|--------|---------------|-------------------------|----------------------------|
| Central Remote Controller | ○ | ○ | ○ | ○ | ○ | ○ | ○ |
| ON / OFF controller | ○ | ○ | ○ | ○ | ○ | ○ | ○ |
| Schedule timer | ○ | ○ | × | × | ○ | ○ | ○ |
| D-BIPS | ○ | ○ | × | × | ○ | ○ | ○ |
| Contact input | ○ | ○ | ○ | ○ | × | ○ | ○ |
| Wired Remote Controller | ○ | ○ | ○ | ○ | ○ | × | × |
| Wireless Remote Controller | ○ | ○ | ○ | ○ | ○ | × | ○ |

WARNING

- Do not install the unit in a location where it may be exposed to water.
- Install the unit indoors.

1. Removal of upper HA casing

① Insert a flat-blade screwdriver into the groove between the upper and lower casings.

② Lift the handle of the screwdriver upward.

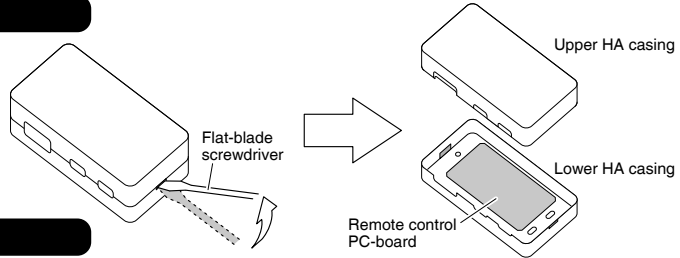

2. Securing of lower HA casing

Mount and secure the lower HA casing directly on the wall with the provided screws inserted into the screw holes (a round hole and two ellipse holes) of the casing.

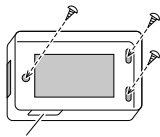

NOTE

Mount so that the wiring through-hole faces downward. If water droplets, dirt, dust, etc., get inside, smoke, fire, or malfunctioning may result.

3. Connection of wiring

Connect the wiring to the connector terminals.

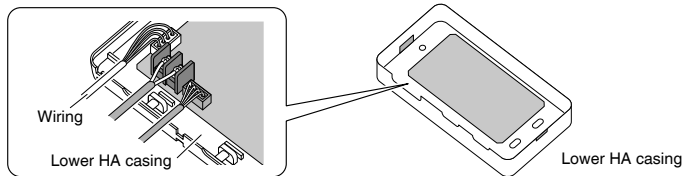

4. Fixation of wiring

① Insert the provided binding band under the pillar of the HA casing and secure the covers of the wiring with the binding band.

② Insert the second binding band into the groove on the side of the HA casing and fix the wiring securely so that the wiring will not be disconnected.

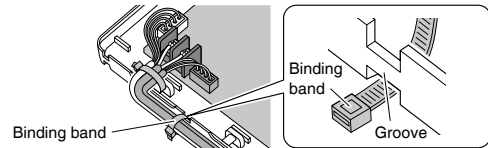
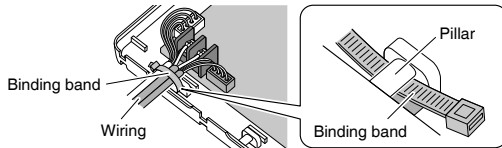

A large number of wires

Make a slit with an appropriate tool, such as a cutter knife, on the thin part of the upper HA casing along the frame. Then cut the part with an appropriate tool, such as a pair of nippers.

(NOTE) Cut off only the thin part required for wiring.

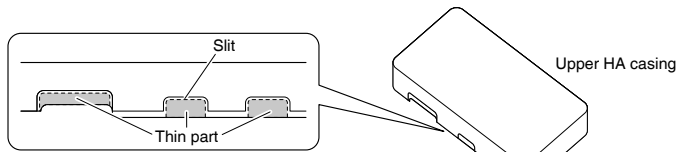

5. Finishing

Mount the upper HA casing to the original position.

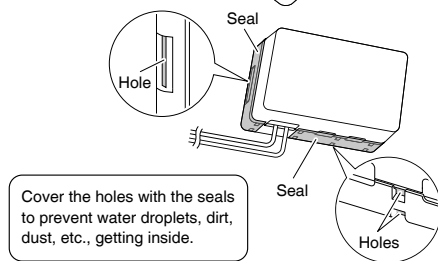
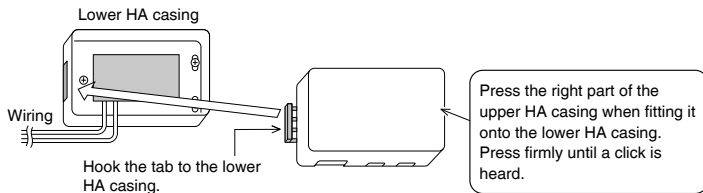

Information

When the contact input device (such as card keys) and central controller are used in tandem:

Even when the operating mode of the S1 pin is set to prohibit all remote controller actions, run/stop operation from the central controller is possible. The operation also starts when the power ON timer of the indoor unit is up while all remote controller actions are prohibited. (*) In this case, stop the operation from the central controller. For the compatible models of the (KRC944 series) remote controller, the operation can be prohibited by using the remote controller in tandem with the central controller. *If this product is connected to an air conditioner manufactured in or after 2011, when the contact is closed, the power ON timer may be cancelled depending on the combination with the model.

2.14 <KRP067A41> Remote Control PC-Board Set

Safety Considerations

- Read these **Safety Considerations** carefully to ensure correct installation.
- This manual classifies the precautions into **WARNING** and **CAUTION**. Be sure to follow all the precautions below: they are all important for ensuring safety.

⚠ WARNING : Failure to follow any of WARNING is likely to result in such grave consequences as death or serious injury.

⚠ CAUTION : Failure to follow any of CAUTION may in some cases result in grave consequences.

⚠ WARNING

- **Installation shall be left to the authorized dealer or another trained professional. Improper installation may cause water leakage, electrical shock, fire, or equipment damage.**
- **Be sure to use the supplied or exact specified installation parts. Use of other parts may cause the unit to come to fall, water leakage, electrical shock, fire or equipment damage.**
- **Be sure to switch off the unit before touching any electrical parts.**
- **Be sure to install a ground fault circuit interrupter / earth leakage circuit breaker. Failure to install a ground fault circuit interrupter / earth leakage circuit breaker may result in electrical shock, fire or personal injury.**

⚠ CAUTION

- **Do not install the air conditioner where gas leakage would be exposed to open flames. If the gas leaks and builds up around the unit, it may catch fire.**
- **Touch a nearby metal object (doorknob, aluminium sash, etc.) to discharge static electricity from your body before touching this set.**
(Static electricity from your body can damage this set.)
- **Lay the cable separately from other power cables.**
(Poor wiring may cause external electrical noise.)
- **After completing installation, test the unit to check for installation errors. Give the user adequate instructions concerning the use and cleaning of the unit according to the Operation Manual.**

Outline / Features

This set is an interface that connects a central control device to a room air conditioner and allows you to perform the following operations, or monitoring, in combination with the central control device using KRP413AB1S or KRP928BB2S (sold separately).

- Starting and stopping the air conditioner, and setting the mode and temperature, through the central control device or the wired remote controller. (64°F to 90°F (18°C to 32°C) in COOL operation, 57°F to 82°F (14°C to 28°C) in HEAT operation, none in FAN operation)
- Monitoring the operating conditions, occurrence of errors, and contents of errors of the air conditioner through the central control device or the wired remote controller.
- Restricting the operation with a wireless remote controller found near the air conditioner, such as starting and stopping operation, changing the mode, or setting the temperature, through the use of the central control device, coin timer, or card key.
- Zone control through the central control device.
- Restoring the operating conditions of the air conditioner to the previous conditions at the time of power recovery in case of power outage.

This set does not support the following functions.

- Group control (i.e., the control of multiple indoor units through a single remote controller)
- Monitoring of the following items: Indoor temperature and operating conditions of thermo, compressor, indoor fan, electric heater, and humidifier
- Control of the following items: Forced thermo OFF, filter sign display and reset, airflow direction, airflow rate setting, and air-conditioner charge management
- Energy-saving command, low-noise command, and demand command

Components

This set includes the following components. Please confirm them.

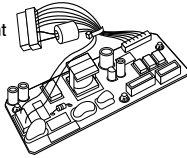
| Component | Quantity | Component | Quantity |
|---|----------|---------------------|----------|
| Main component  | 1 | Installation Manual | 1 |

Installation Procedure

Installation Position

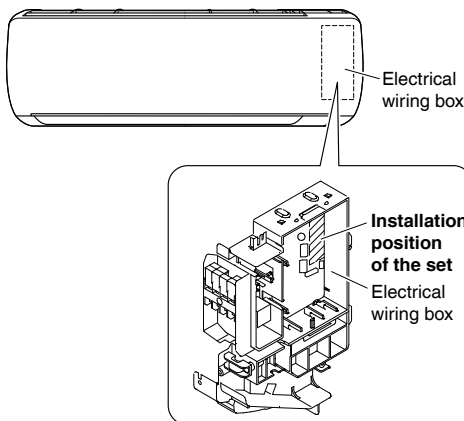

Wiring Outline

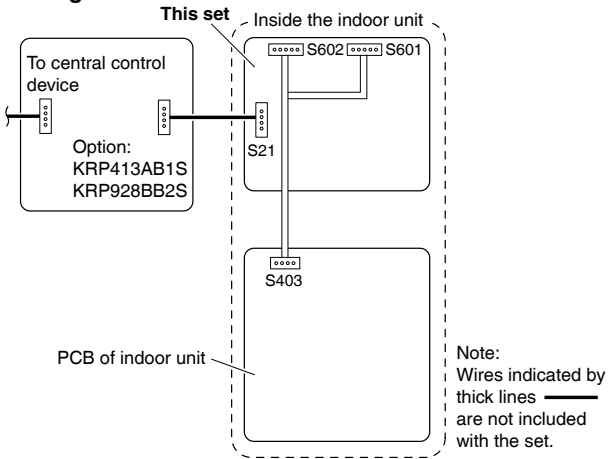

Removal and Installation of Front Panel

• Removal method

- 1) Place your fingers in the indentations on the main unit (one each on the left and right sides), and open the panel until it stops.
- 2) Continue to open the front panel further while sliding the panel to the left and pulling it toward yourself in order to disengage the rotating shaft on the left side. To disengage the rotating shaft on the right side, slide the panel to the right while pulling it toward yourself.

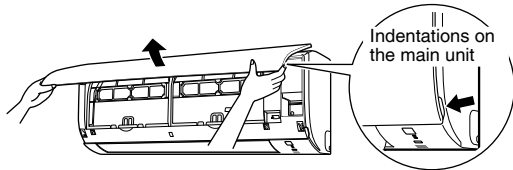

• Installation method

Align the rotating shaft of the front panel with the grooves, and push all the way in. Then close slowly. Push both the sides and the center of the lower surface of the panel firmly.

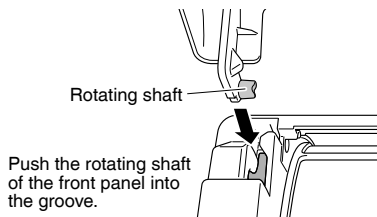

Opening Service Lid of Indoor Unit

The service lid is of removable type.

• Opening method

- 1) Remove the single screw of the service lid.
- 2) Pull out the service lid frontward.

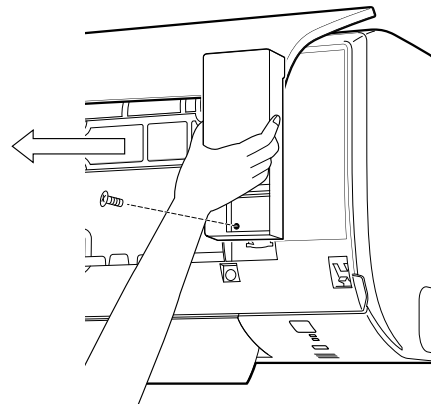

Removal and Installation of Front Grille

• Removal method

- 1) Remove front panel.
- 2) Remove the air filter.
- 3) Remove the screws (2) from the front grille.
- 4) Disengage 3 hooks (the location can be identified by ○○○ mark) at the top of the grille.

< When there is no work space because the unit is close to ceiling >

⚠ CAUTION

Be sure to wear protection gloves.

Disengage the flap (horizontal blade), and pull the lower part of the front grille toward yourself to remove it. If it is difficult to remove, place both hands under the center of the front grille, and while pushing up, pull it toward yourself.

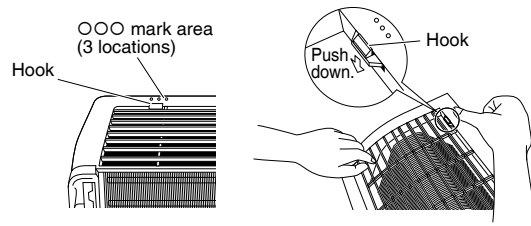
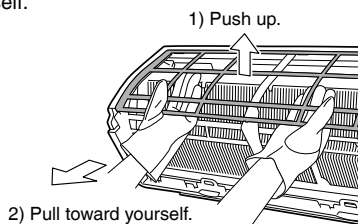

• Installation method

- 1) Install the front grille and firmly engage the upper hooks (3 locations).
- 2) Insert 2 screws of the front grille.
- 3) Install the air filter then mount the front panel.

Removal of Electrical Wiring Box Cover

1. Remove the front panel and the front grille and service lid of indoor unit.
(Refer to the front page for the removal of each part in detail.)
2. Remove the electrical wiring box cover.

⚠ WARNING

- Be sure to turn OFF the power at the time of installation work.
Touching any electric parts with the power turned ON may cause electric shock.

Electrical wiring box
If there is workspace on the right-hand side of the indoor unit, the installation work can be conducted without removing the electrical wiring box.

After connecting the HA PCB (this set), return all removed parts to their original positions.

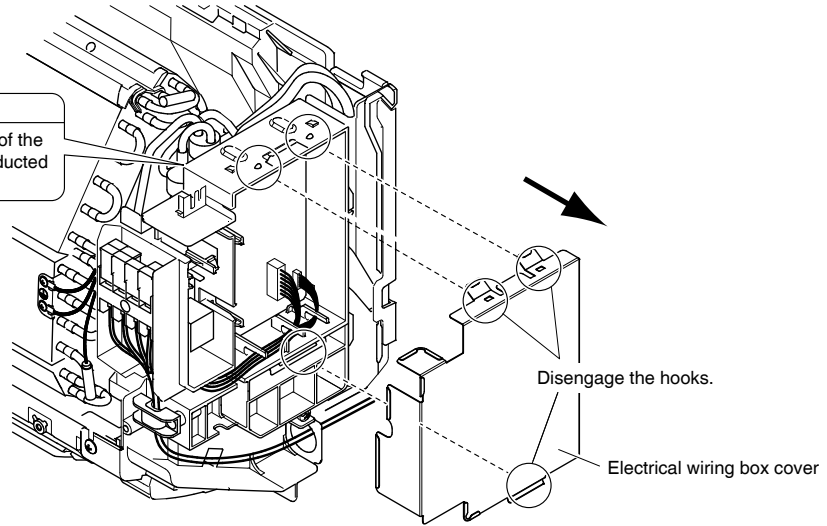

Removal of Electrical Wiring Box

If there is workspace on the right-hand side of the indoor unit, the installation work can be conducted without removing the electrical wiring box. Connect HA without removing the electrical wiring box, if possible.

1. Disconnect the inter-unit wire.
2. Disconnect the fan motor connector (S200) and swing motor connector (S6).
3. Disconnect the thermistor and ground/earth wire from the heat exchanger (2 screws).
(Some models may not have ground/earth wire.)
4. Remove the mounting screw of the electrical wiring box (1 screw).

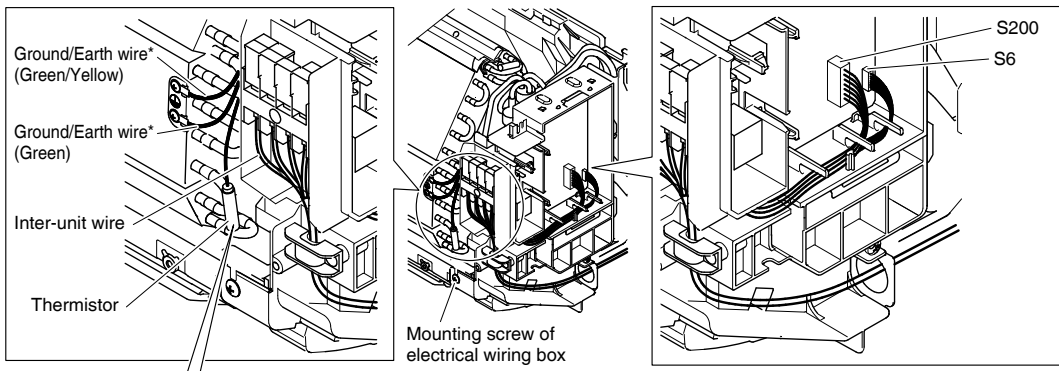

Make sure that the mounting bracket of the thermistor will not fall off.

*The position of the ground/earth wire may differ depending on the model

After connecting the HA PCB (this set), return all removed parts to their original positions.

Connecting HA PCB

1. Install the HA PCB (this set). (See Fig. 1)

- 1) Install the HA PCB (this set) to the electrical wiring box.
- 2) Insert the connector of the HA PCB (this set) to the connector (S403) on the electrical wiring box.

2. Connect the HA connection cord. (See Fig. 1 and 2)

- 1) Insert the HA connection cord into the HA connector "S21" (white) on the HA PCB (this set).
- 2) Route the HA connection cord as shown in Fig. 2.

Fig. 1 Connection points of the HA PCB

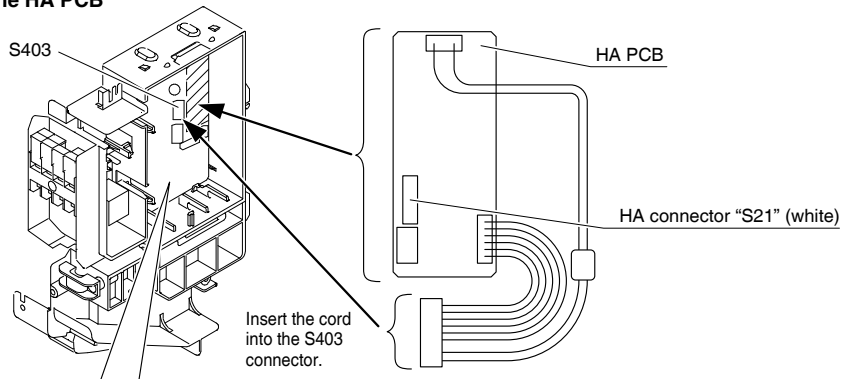

Installing HA PCB on the electrical wiring box

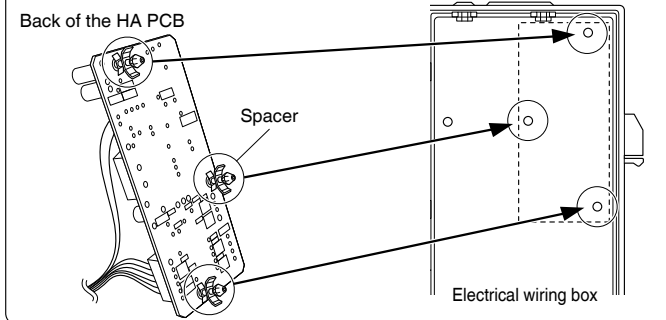
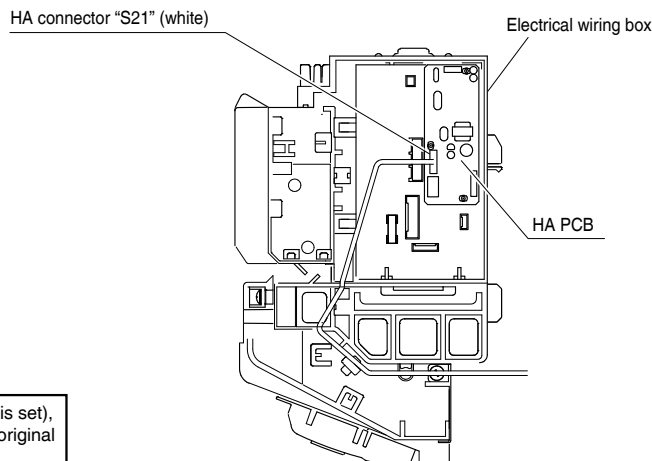

Fig. 2 Routing HA connection cord





After connecting the HA PCB (this set), return all removed parts to their original positions.

3. Outdoor Unit

3.1 <KPW063B4> Air Direction Adjustment Grille

Component parts Be sure to check that the following parts are included before installation.

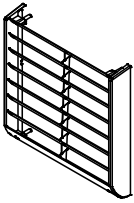
Component parts

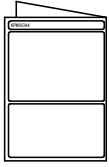
| Name | ① Air direction adjustment grille | ② Screw | ③ Spacer | ④ Installation Manual |
|--------------|---|---|--|---|
| Illustration |  |  |  |  |
| Quantity | 1 pcs. | 4 pcs. | 4 pcs. | 1 sheet (this sheet) |

Selection of installation site

Install only on an outdoor unit in a location that satisfies the following conditions:

- When installing the outdoor unit near the neighbouring house.
- Where you wish to change the exhaust airflow direction because the outdoor unit has been installed facing a road, so that passing people are not exposed to its exhaust air
- When changing the airflow direction to prevent exhaust blowing directly onto passersby or garden plants.

Cautions for usage

- Be sure to perform the following as installation precautions to ensure correct and safe use of the air direction adjustment grille.
 1. Install the product so that it is situated high enough to allow access to the outdoor unit for maintenance purposes.
 2. When installing the product in a location in which it may be exposed to strong winds, install a rollover prevention bracket (sold separately) at the same time.
 3. Tighten screws securely. Failure to do so may result in vibration.

① Verifying the amount of space required for installation

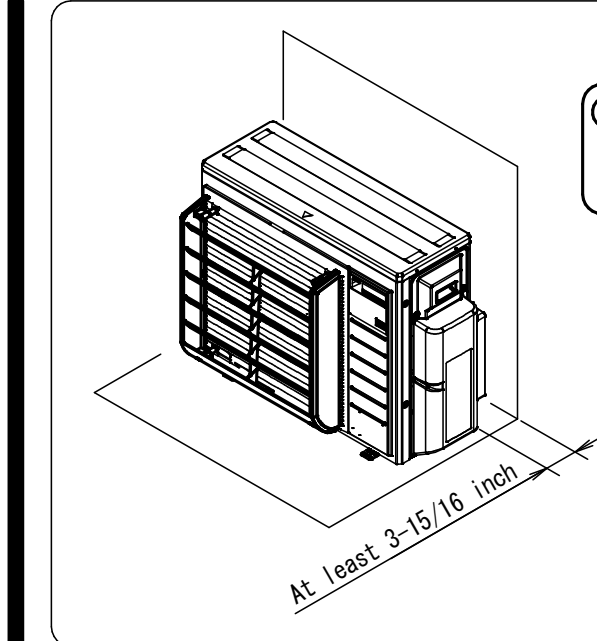

⚠ Caution

Leave at least 3-15/16 inch between the rear of the outdoor unit and any obstructions (walls, etc.).

2 Installation of air direction adjustment grille

⚠ Caution

Install the air direction adjustment grille on top of the outlet grille.
Be sure to install the outlet grille as installing only the air direction adjustment grille would allow a person to reach his or her hand into the outdoor unit far enough to come into contact with the rotating fan.

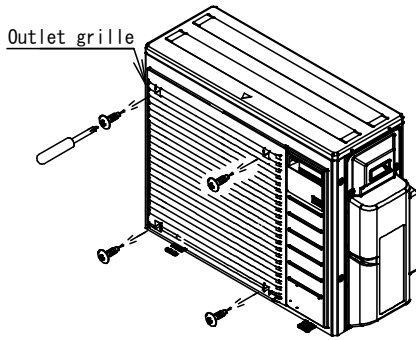

- (1) Remove the 4 outlet grille fixing screws.
- (2) Referring to the following illustration, attach the outlet grille and air direction adjustment grille, taking care to align them with the air outlet direction.
- Attach the air direction adjustment grille on top of the outlet grille using the same screws.

Upward facing

Downward facing

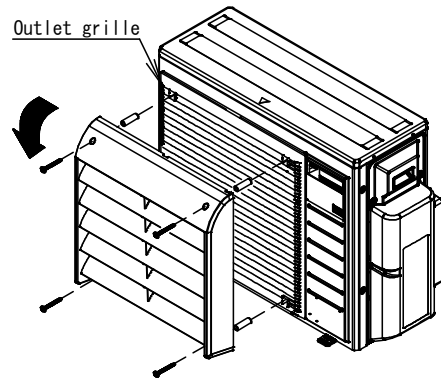
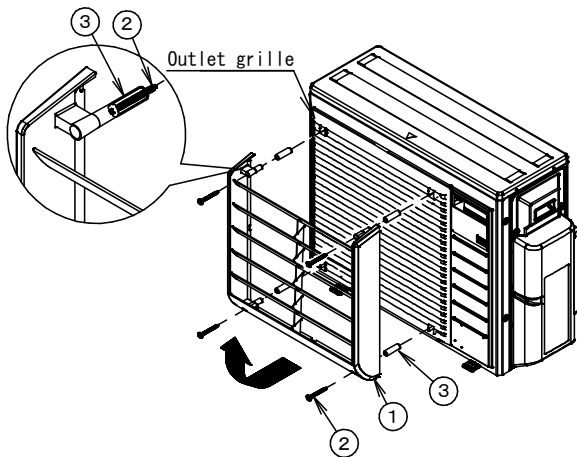

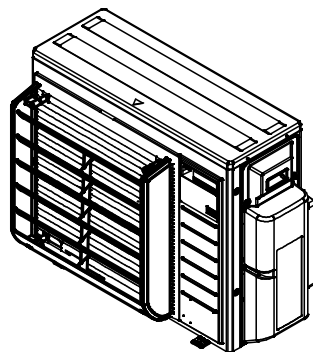

Appearance of the air direction adjustment grille after installation (when installed with the louvers facing up)

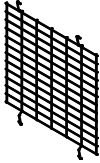

3.2 <KKG063A44> Back Protection Wire Net

Component parts

| Name | ① Protection net | ② Installation manual |
|-------|---|---|
| Shape |  |  |
| Q'ty | 1pc. | 1sheet (this sheet) |

Caution

Be sure to wear protection gloves when performing installation work as the fins on the heat exchanger may cause injury.

Part names

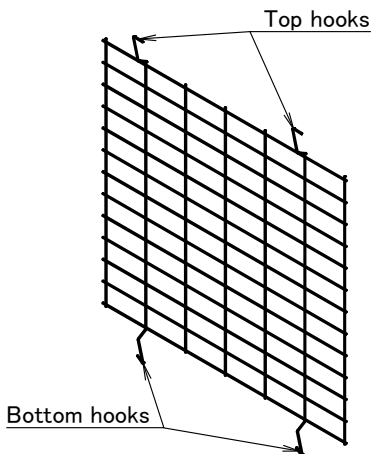

2 Attach the protection net (①)

Orient the protection net (①) so that top and bottom hooks are facing the heat exchanger and insert the two bottom hooks between the heat exchanger and the bottom frame.

Insert the two top hooks between the heat exchanger and the top panel while flexing the protection net (①).

※ Be careful not to damage the heat exchanger's cooling tubes.

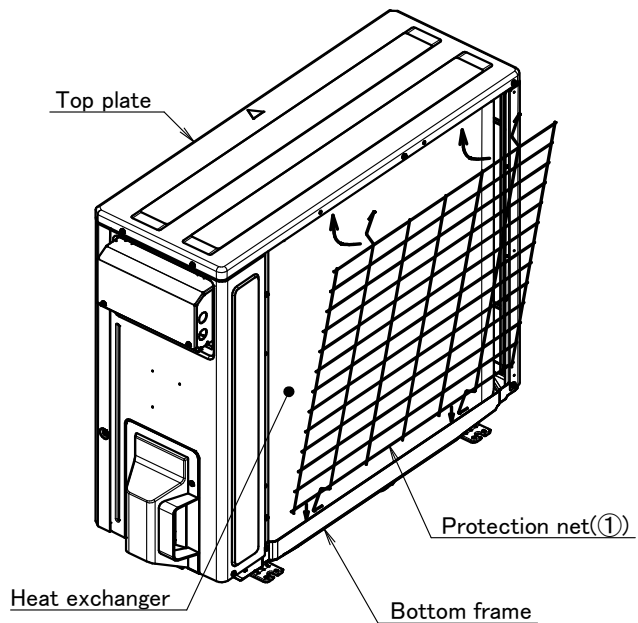

1 Verify the location at which the protection net (①) is to be installed.

Attach the protection net (①) so that the vertical grating is aligned with the edge of the installation leg on the right side of the outdoor unit.

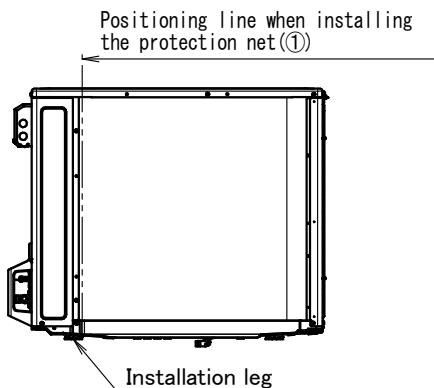

3 Appearance of the protection net (①) following installation

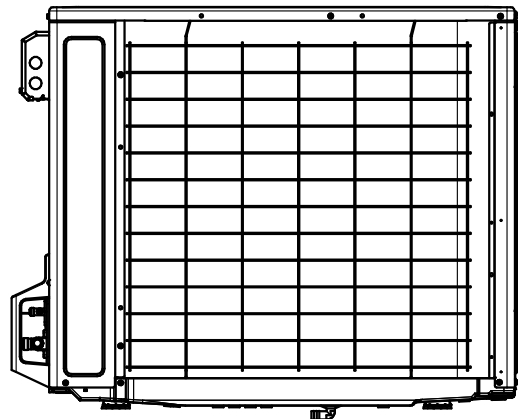

3.3 <KEH064A41> Drain Pan Heater

Safety Considerations

Give this installation manual to the user when installation is completed.

- Read these **Safety Considerations** carefully to ensure correct installation.
- After completing the installation, make sure that the unit operates properly during the startup operation.
- All phases of the field-installation, including, but not limited to, electrical, piping, and safety, must be done in accordance with manufacturer's instructions and must comply with national, state, provincial, and local codes.
- This product is a heater designed to melt snow that is blown into the product from the outside to prevent the drain pan of the outdoor unit from freezing.
- Install the product with a snow-break hood on a high stand if this product is used in heavy snow areas.
- Meaning of **DANGER**, **WARNING** and **CAUTION** symbols:

⚠ DANGER : Indicates an imminently hazardous situation which, if not avoided, will result in death or serious injury.

⚠ WARNING : Indicates a potentially hazardous situation which, if not avoided, could result in death or serious injury.

⚠ CAUTION : Indicates a potentially hazardous situation which, if not avoided, may result in minor or moderate injury. It may also be used to alert against unsafe practices.

⚠ DANGER _____

- Do not touch the heater unit without wearing gloves. The temperature of the heater unit will become high when the heater is turned on. Touching the heater unit with bare hands will result in burns or injury.





⚠ WARNING _____

- Only qualified personnel must carry out the installation work. Installation must be done in accordance with this installation manual. Improper installation may result in electric shock, fire, or equipment damage.
- Use only specified accessories and parts for installation work. Failure to use specified parts may result in electric shock, fire, the product falling, or equipment damage.
- Before touching electrical parts, turn off the unit.
- Use specified wires. Connect and fix the wires so that the wires will not put improper force on the terminal junctions. Wires connected or fixed improperly could result in terminal overheating, an electric shock, or fire.

⚠ CAUTION _____

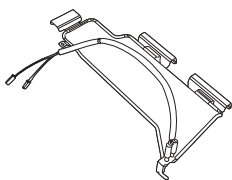
- Wear protective gloves at the time of installation. Touching the suction mouth or aluminum fin of the outdoor unit may result in injury.
- Do not install the product in places where there is danger of exposure to inflammable gas leakage. If the gas leaks and builds up around the unit, it may catch fire.
- Do not grab the top plate of the outdoor unit carelessly when removing the top plate. The sharp edge of the top plate may cause injury.

Accessories

| | | | | |
|---|---|------------------------------------|---|---|
| (A) Drain pan heater  | 1 | (B) Screw M4 × 5/16" (M4 × 8mm) |  | 3 |
| | | (C) Installation Manual |  | 1 |
| | | (D) Information label |  | 1 |

Tools Required for Installation

- Phillips screwdriver
- Nippers

Installation Procedure (1)

⚠ WARNING

- Be sure to check that the power supply of the product is turned off.

Some stages in the installation procedure differ by model of outdoor unit. Refer to the instructions for the relevant model.

Type A models : RX

Type B models : 2/3/4MX

1. Remove each component of the outdoor unit.

- 1) Remove the top plate.
- 2) Remove the screws from the protective wire mesh if one is fitted. (2 screws)
- 3) Remove the front plate.
- 4) Remove the anti-drip cover.
- 5) Affix the ⓘ information label near the manufacturer's label.

- Screw types for each component are indicated as below.

No icon: Hexagon tapping screw
 △ : Truss head tapping screw

For type A models

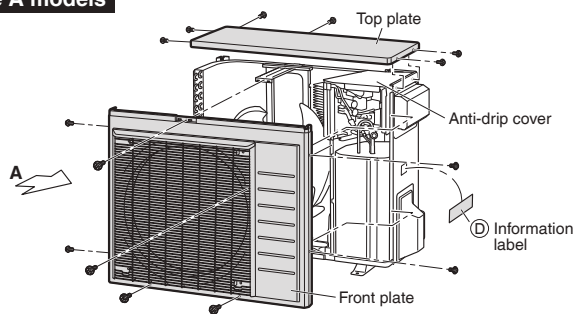

For type B models

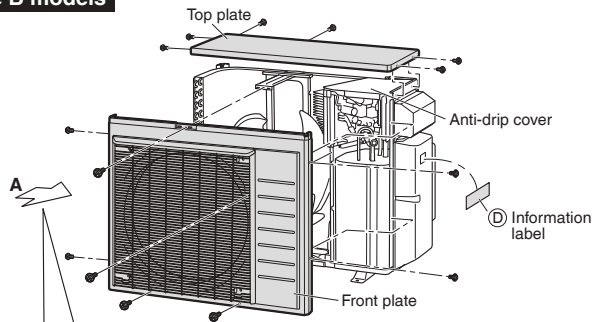

View A

Protective wire mesh

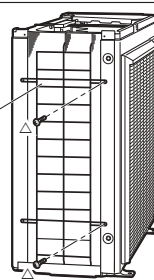

2. Remove the fan motor base.

- 1) Remove the fixing screws at the lower section of the fan motor base. (2 screws)
- 2) Remove the fan motor base together with the propeller fan and ensure that stress is not placed on the propeller fan when placing them aside.
 - Do not remove the fan motor harness.
 - Ensure that the fan motor harness does not come into contact with the edges of the heat exchanger or other components.

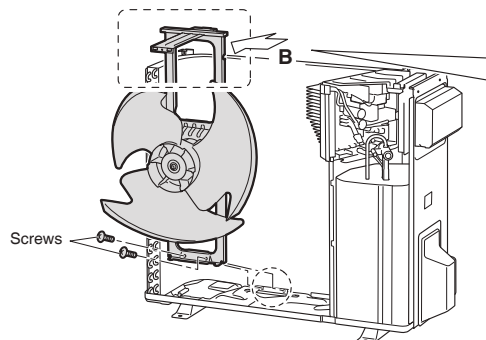

View B

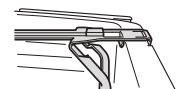

The lugs of the fan motor base are hooked on the heat exchanger.

Appearance of the outdoor unit may differ from some models.

Installation Procedure (2)

3. Install the (A) drain pan heater.

- 1) Remove 1 screw from the bottom frame so that the plates of the (A) drain pan heater can be inserted under the heat exchanger with ease.
- 2) Lift up the heat exchanger, and insert the plates of the (A) drain pan heater under the heat exchanger.
 - The ground plate of the (A) drain pan heater should be installed so that it firmly adheres to the bottom frame.
 - Install the (A) drain pan heater in a position where it does not come into contact with the fan motor base.
- 3) Fix the (A) drain pan heater with the (B) screws.
- 4) Reattach the screw that was removed from the bottom frame.

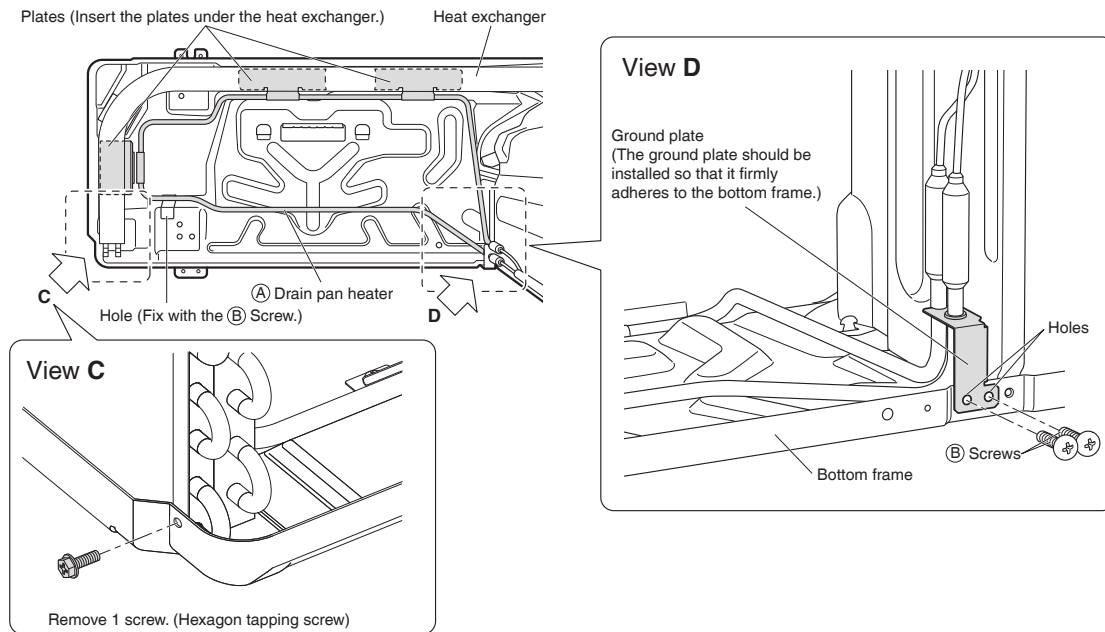

4. Route the harnesses.

- 1) Trim the electrical wiring box with nippers at the locations shown in the figures.
- 2) Insert the drain pan heater harness into the space that was trimmed.
- 3) Secure the drain pan heater harness snap band in the hole in the partition plate.
- 4) Install the fan motor base.
 - Be careful not to confuse screw types. Refer to “Installation Procedure (1)”.

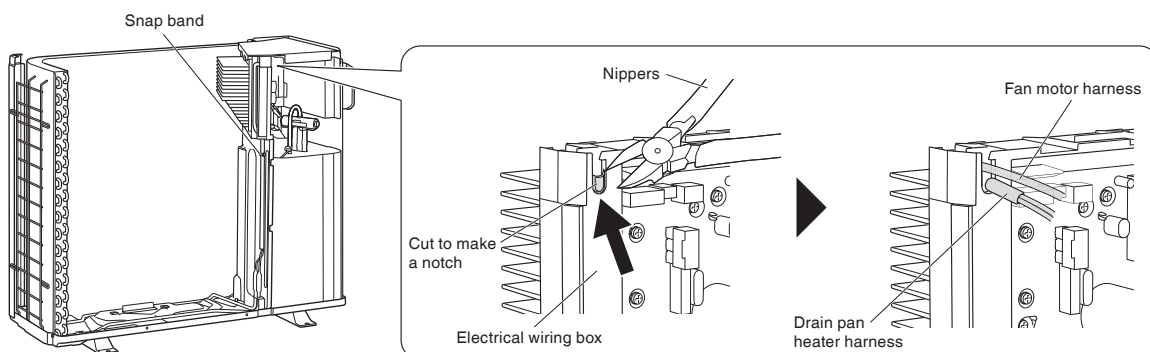

Installation Procedure (3)

For type A models

- 5) Connect the fasten terminals to DP1 and DP2 on the PC-board.
- Either drain pan heater fasten terminal can be connected to either DP1 or DP2 with no problem.

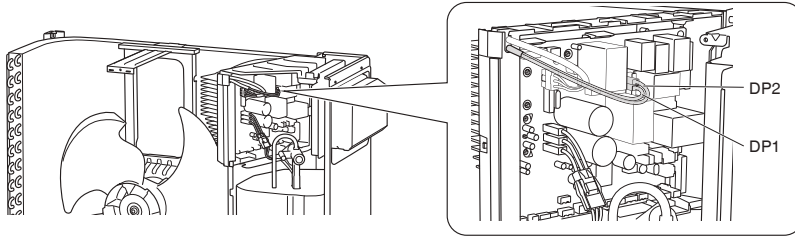

For type B models

- 5) Connect the fasten terminals to DP3 and DP4 on the PC-board.
- Either drain pan heater fasten terminal can be connected to either DP3 or DP4 with no problem.

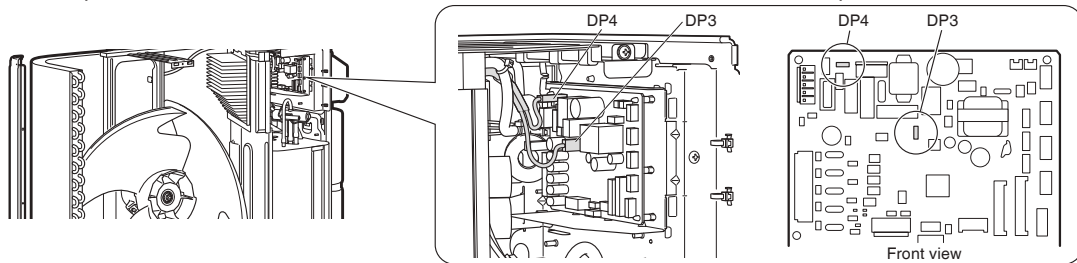

5. Cut the jumper.

For type A models

- Using a tool such as nippers, cut the jumper (J9) of the PCB inside.

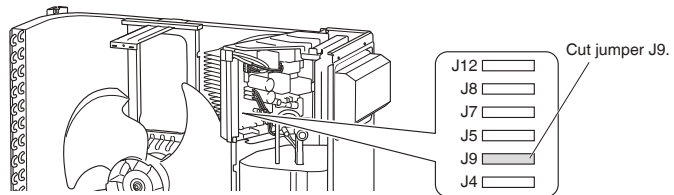

For type B models

- Using a tool such as nippers, cut the jumper (J_DP) on the service PC-board.
- Using the removed truss head tapping screw, reattach the switch cover.

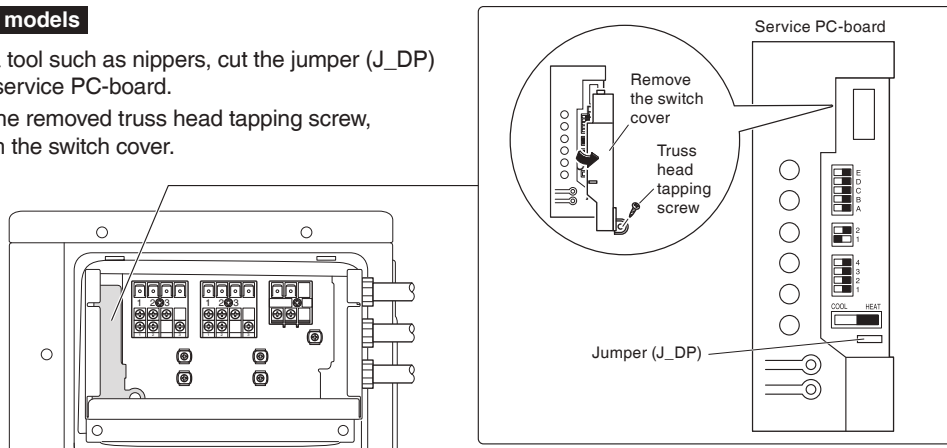

6. Install each component to the original position.

- Be careful not to confuse screw types. Refer to "Installation Procedure (1)".

3.4 <KPS063A41> Snow Hood (Side)

Parts Before assembling the product, verify that all of the following parts have been included:

| Name | Side plate (right) | Side plate (left) | Top plate | Front plate | Screws | Installation Manual |
|--------------|--------------------|-------------------|-----------|-------------|--------------------------|---------------------|
| Illustration | | | | | (quantity to use 14) | |
| Quantity | 1 | 1 | 1 | 1 | 16 | 1 (this document) |

Caution Read these safety considerations for installation carefully before installing the product.

Be sure to observe the following installation precautions to ensure that the product can be used safely:

1. Install the product so that it is situated high enough to allow access to the outdoor unit for maintenance.
2. Installing the product in a location in which it may be exposed to strong winds, secure the outdoor unit with wire or other means.
3. Choose a location where the operating sound will not cause a nuisance to the neighbors of the user.
4. Tighten screws securely. Failure to do so may result in vibration.

Caution Indicates a potentially hazardous situation which, if not avoided, may result in minor or moderate injury. It may also be used to alert against unsafe practices.

1 Installing the snow hood (intake side plate)

1 Remove the protective wire mesh

1. Remove the 2 screws that hold the protective wire mesh.
2. Remove the 6 screws that hold the top plate and remove the top plate.
3. Remove the protective wire mesh, being careful of the part that is attached to the heat exchanger.
4. Attach the top plate removed in step 2 using the 6 screws removed in step 2.

2 Attach the side plate (right) ①

1. Install the side plate (right) ① with the 2 screws that were used in the protective wire mesh that was removed in step 1.

- Use the second hook slot from the top and the 2 screw hole from the bottom.
- Installation is easiest if you start with the hook slot.

3 Attach the side plate (left) **2**.

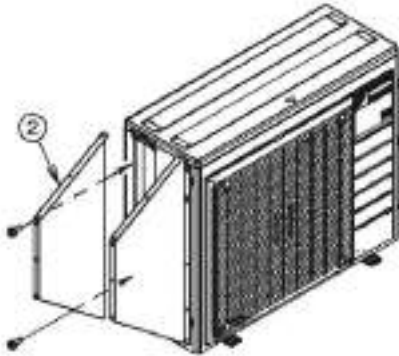

1. Install the side plate (left) **2** with the 2 screws that were used in the protective wire mesh that was removed in step **1**.

- Use the second hook slot from the top and the 2 screw hole from the bottom.
- Installation is easiest if you start with the hook slot.

4 Attach the front plate **4**.

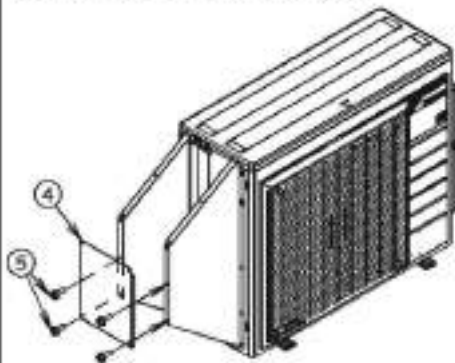

1. Temporarily secure the front plate **4** in place with the 4 screws **5**.

5 Attach the top plate **3**.

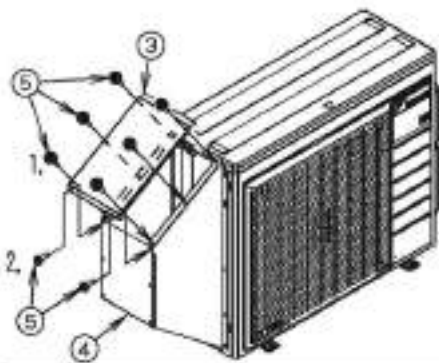

1. Attach the top plate **3** with the 6 screws **5**.
2. Temporarily secure the top plate **3** and the front plate **4** to the side plate (right) **1** and the side plate (left) **2** with the 2 screws **5**.
3. Tighten the 12 screws **5** that you used to temporarily secure parts in steps **4** and **5**.

2 Appearance of the snow hood (intake side plate) after installation

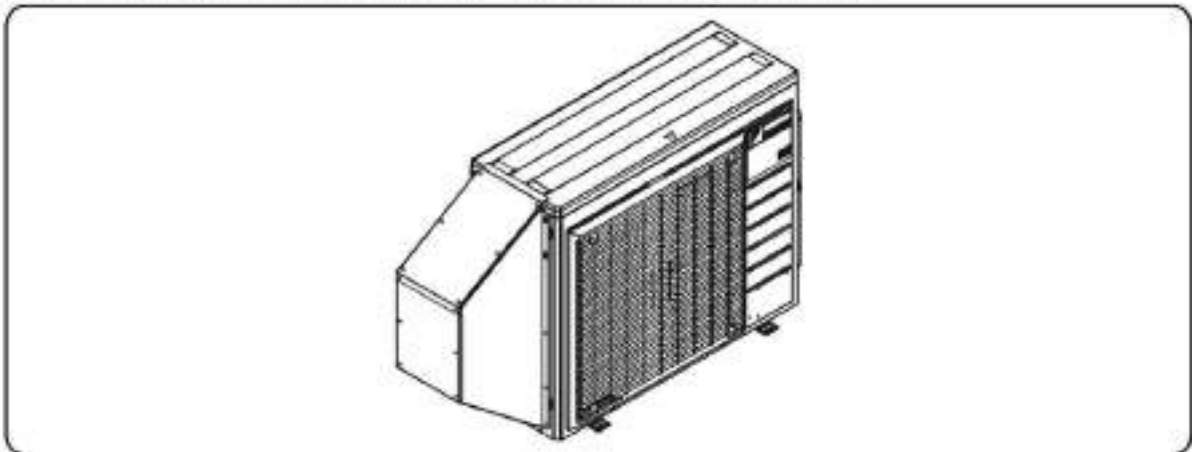

3.5 <KPS063A44> Snow Hood (Rear)

Parts Before assembling the product, verify that all of the following parts have been included:

| Name | Side plate (Right) | Side plate (Left) | Top plate | Front plate | Screws | Piercing screw | Installation Manual |
|--------------|--------------------|-------------------|-----------|-------------|--------|----------------|---------------------|
| Illustration | | | | | | | |
| Quantity | 1 | 1 | 1 | 1 | 14 | 3 | 1 (this document) |

⚠ Caution Read these safety considerations for installation carefully before installing the product.

Be sure to observe the following installation precautions to ensure that the product can be used safely:

1. Install the product so that it is situated high enough to allow access to the outdoor unit for maintenance.
2. Installing the product in a location in which it may be exposed to strong winds, secure the outdoor unit with wire or other means.
3. Choose a location where the operating sound will not cause a nuisance to the neighbors of the user.
4. Tighten screws securely. Failure to do so may result in vibration.

⚠ Caution
Indicates a potentially hazardous situation which, if not avoided, may result in minor or moderate injury. It may also be used to alert against unsafe practices.

1 Installing the snow hood (intake rear plate)

1 Attach the side plate (right) ①.

1. Use the 3 piercing screws ⑥ included in the kit to install the side plate (right) ①.

- For the hook slot, use the first hook slot from the top.
- For the screw hole, use the first screw hole from the bottom.
- Installation is easiest if you start with the hook slot.
- Align the screw installation position with the dowel hole.

2 Attach the side plate (left) ②

1. Remove the 2 screws (★) that hold the heat exchanger.
2. Install the side plate (left) ② using the 2 screws removed in step 1.

3 Attach the front plate ④

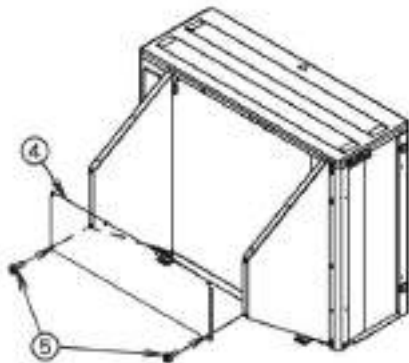

1. Temporarily secure the front plate ④ in place with the 2 screws ⑤ included in the kit,

4 Attach the top plate ③

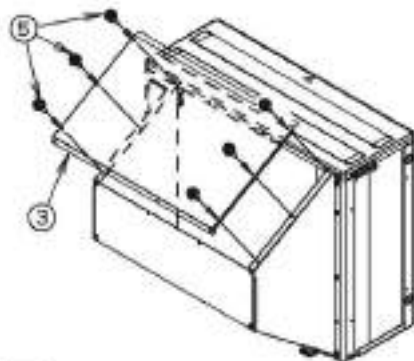

1. Temporarily secure the top plate ③ in place with the 6 screws ⑤ included in the kit,

5 Attach the top plate ③

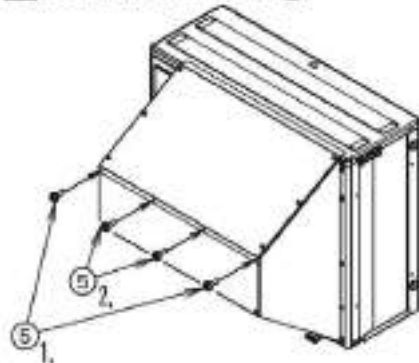

1. Temporarily secure the top plate ③ and front plate ④ to the side plate (right) ① and side plate (left) ② with the 2 screws ⑤ included in the kit,
2. Temporarily secure the top plate ③ to the front plate ④ with the 2 screws ⑤ included in the kit,
3. Tighten the 12 screws that you used to temporarily secure parts in steps 3), 4), and 5),

2 Appearance of the snow hood (intake rear plate) after installation

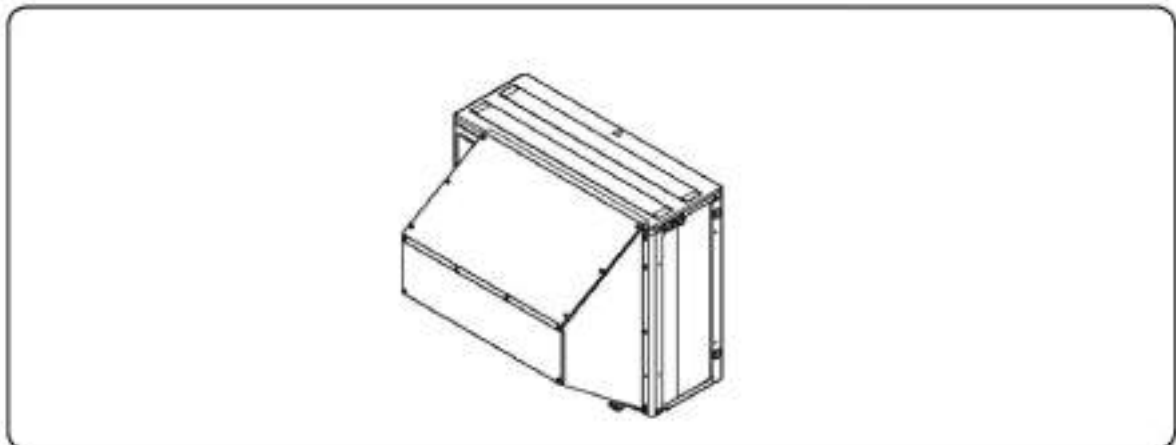

3.6 <KPS063A47> Snow Hood (Discharge)

Parts Before assembling the product, verify that all of the following parts have been included:

| Name | Side plate | Side plate | Top plate | Installation plate | Screws | Piercing screw | Installation Manual |
|--------------|------------|------------|-----------|--------------------|--------|----------------|---------------------|
| Illustration | ① (Right) | ② (Left) | ③ | ④ | ⑤ | ⑥ | ⑦ |
| Quantity | 1 | 1 | 1 | 1 | 8 | 3 | 1 (this document) |

Caution Read these safety considerations for installation carefully before installing the product.

- Be sure to observe the following installation precautions to ensure that the product can be used safely:
 1. Install the product so that it is situated high enough to allow access to the outdoor unit for maintenance.
 2. Installing the product in a location in which it may be exposed to strong winds, secure the outdoor unit with wire or other means.
 3. Choose a location where the operating sound will not cause a nuisance to the neighbors of the user.
 4. Tighten screws securely. Failure to do so may result in vibration.

Caution
Indicates a potentially hazardous situation which, if not avoided, may result in minor or moderate injury. It may also be used to alert against unsafe practices.

1 Installing the snow hood (outlet)

1 Remove the discharge grille.

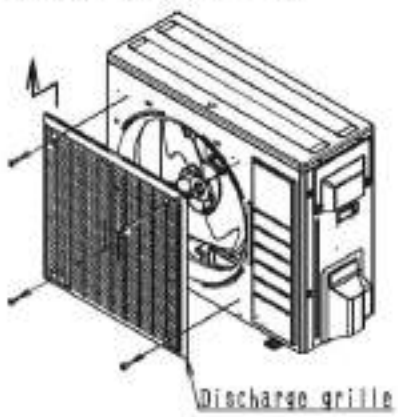

1. Remove the 4 screws that hold the discharge grille. (The discharge grille is held with the 4 screws and 2 hooks.)

2 Attach the side plate (left) ② and installation plate ④.

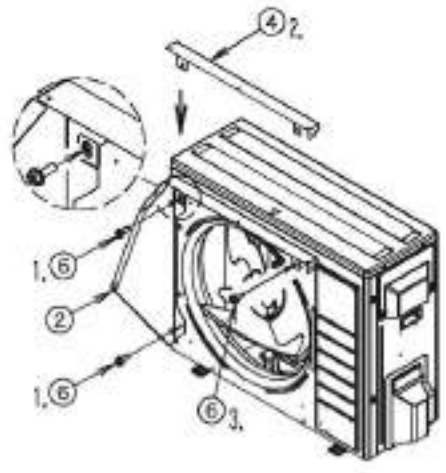

1. Temporarily secure the side plate (left) ② in place with the 2 piercing screw ⑥ included in the kit.

• Installation is easiest if you start with the hook slot.
• Align the screw installation position with the dowel hole.

2. Jointly tighten the installation plate ④ with the 1 piercing screw ⑥ temporarily secured in step 1.
3. Install the right side of the installation plate ④ with the 1 piercing screw ⑥.

3 Attach the installation plate ④.

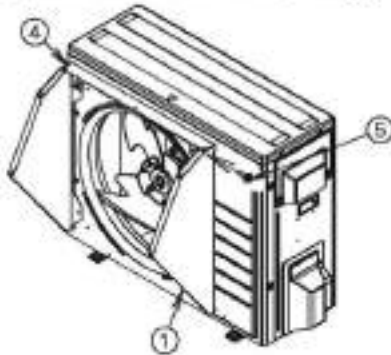

1. Install the side plate (right) ① and installation plate ④ with the 1 screws ⑤ included in the kit.

4 Attach the discharge grille.

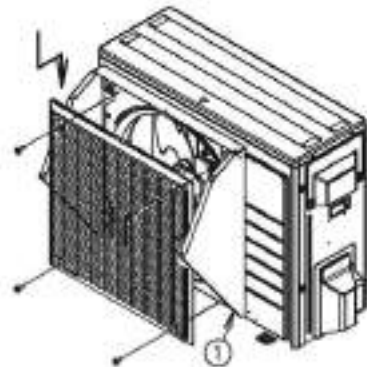

1. When installing the discharge grille removed in [1], jointly tighten the side plate (right) ① with the 2 screws securing the discharge grille. (Secure the discharge grille with the 4 screws and 2 hooks.)

5 Attach the top plate ③.

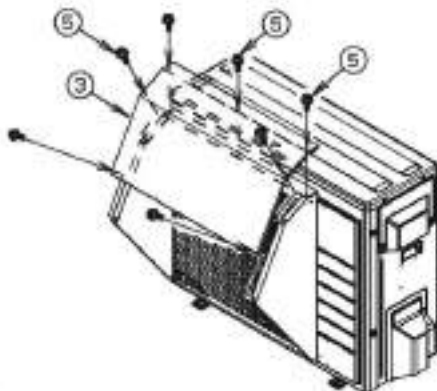

1. Install the top plate ③ with the 7 screws ⑤ included in the kit.

2 Appearance of the snow hood (outlet) after installation

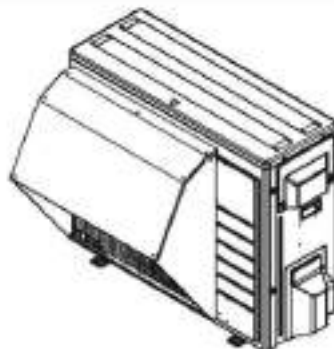

Warning



- Ask a qualified installer or contractor to install this product. Do not try to install the product yourself. Improper installation can result in water or refrigerant leakage, electrical shock, fire or explosion.
- Use only those parts and accessories supplied or specified by Daikin. Ask a qualified installer or contractor to install those parts and accessories. Use of unauthorized parts and accessories or improper installation of parts and accessories can result in water or refrigerant leakage, electrical shock, fire or explosion.
- Read the user's manual carefully before using this product. The user's manual provides important safety instructions and warnings. Be sure to follow these instructions and warnings.

If you have any inquiries, please contact your local importer, distributor and/or retailer.

Cautions on product corrosion

1. Air conditioners should not be installed in areas where corrosive gases, such as acid gas or alkaline gas, are produced.
2. If the outdoor unit is to be installed close to the sea shore, direct exposure to the sea breeze should be avoided. If you need to install the outdoor unit close to the sea shore, contact your local distributor.